

# **LWU701i/LW751i/LX801i/LWU601i/LW651i**

## **User's Manual (detailed) Network Guide**

020-000787-03  
LIT MAN USR D2 Network

**CHRISTIE®**



# LWU701i/LW751i/LX801i LWU601i/LW651i

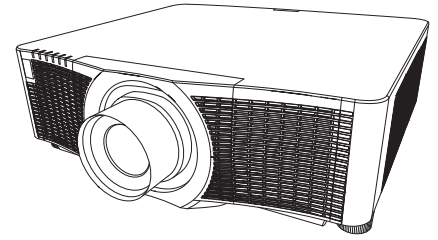

## **User's Manual (detailed) Network Guide**

**Thank you for purchasing this projector.**

This manual is intended to explain only the network function. For proper use of this projector, refer to this manual and the other manuals for this projector.

**⚠ WARNING** ▶ Before using this projector, read all manuals for this projector. After reading them, store them in a safe place for future reference.

### **Features**

This projector has the network function that provides you with the following main features.

- ✓ **Network Presentation** : allows the projector to project computer images transmitted through a network. (📖 77)
- ✓ **Web Control** : allows you to monitor and control the projector through a network from a computer. (📖 37)
- ✓ **My Image** : allows the projector to store up to four still images and project them. (📖 81)
- ✓ **Messenger** : allows the projector to display text sent from a computer through a network. (📖 82)
- ✓ **Network Bridge** : allows you to control an external device through the projector from a computer. (📖 85)

**NOTE** • The information in this manual is subject to change without notice.  
• The illustrations in this manual are for illustrative purposes. They may differ slightly from your projector.  
• The manufacturer assumes no responsibility for any errors that may appear in this manual.  
• The reproduction, transfer or copy of all or any part of this document is not permitted without express written consent.

**Contents**



**Caution** ..... **4**

**1. Network Function** ..... **5**

    1.1 Web Control ..... 5

    1.2 Network Presentation ..... 6

    1.3 My Image Function ..... 7

    1.4 Messenger Function ..... 8

    1.5 Network Bridge Function ..... 9

    1.6 Other Functions ..... 10

        1.6.1 E-mail Alerts ..... 10

        1.6.2 Projector Management using SNMP ..... 10

        1.6.3 Event Scheduling ..... 10

        1.6.4 Command Control via the Network ..... 10

**2. Connection to the network** ..... **11**

    2.1 System requirements ..... 11

    2.2 Connection via wired LAN ..... 12

    2.3 Connection setup of Wired LAN ..... 12

    2.4 Connection via wireless LAN ..... 14

        2.4.1 Connection in Simple Access Point Mode ..... 15

        2.4.2 Connection in Infrastructure Mode ..... 16

    2.5 Applications ..... 18

    2.6 NETWORK Menu ..... 20

**3. Web Control** ..... **37**

    3.1 Projector Web Control ..... 39

        3.1.1 Login ..... 39

        3.1.2 Network Information ..... 40

        3.1.3 Network Settings ..... 41

        3.1.4 Port Settings ..... 46

        3.1.5 Mail Settings ..... 48

        3.1.6 Alert Settings ..... 50

        3.1.7 Schedule Settings ..... 52

        3.1.8 Date/Time Settings ..... 56

        3.1.9 Security Settings ..... 58

        3.1.10 Projector Control ..... 60

        3.1.11 Remote Control ..... 64

        3.1.12 Projector Status ..... 65

        3.1.13 Network Restart ..... 66

        3.1.14 Connection Test ..... 67

	
3.2 Crestron e-Control® .....	68
3.2.1 Main window .....	70
3.2.2 Tools window .....	72
3.2.3 Info window .....	74
3.2.4 Help Desk window .....	75
3.2.5 Emergency Alert .....	76
<b>4. Network Presentation .....</b>	<b>77</b>
4.1 Outline .....	77
4.2 Display Mode .....	78
4.2.1 Single PC mode .....	78
4.2.2 Multi PC mode .....	78
4.3 Multi Projector Mode .....	79
4.4 Moderator Control Mode .....	79
4.5 Port Number .....	80
<b>5. My Image Function .....</b>	<b>81</b>
<b>6. Messenger Function .....</b>	<b>82</b>
6.1 Outline .....	82
6.2 Supported Languages .....	83
6.3 Display Style .....	83
<b>7. Network Bridge Function .....</b>	<b>85</b>
7.1 Connecting devices .....	85
7.2 Communication setup .....	86
7.3 Communication port .....	86
7.4 Transmission method .....	87
7.4.1 HALF-DUPLEX .....	87
7.4.2 FULL-DUPLEX .....	88
<b>8. Other Functions .....</b>	<b>89</b>
8.1 E-mail Alerts .....	89
8.2 Projector Management using SNMP .....	92
8.3 Event Scheduling .....	94
8.4 Command Control via the Network .....	97
8.5 Crestron Connected™ .....	102
<b>9. Troubleshooting .....</b>	<b>103</b>
<b>10. Warranty and after-sales service .....</b>	<b>112</b>

**Caution****Caution**

To use the wireless network function of this projector, the designated USB wireless adapter sold as an option is required. For precautions according to the standards and laws, refer to the documents that come with the adapter.

**[Restriction on plugging and unplugging the USB wireless adapter]**

Before you insert or pull out the USB wireless adapter from the projector, turn off the power of the projector and pull out the power cord's plug from the outlet. Do not touch the USB wireless adapter that is connected to the projector while the projector is receiving AC power.

Do not use any extension cable or device when connecting the adapter to the projector.

**[Security precautions when using wireless LAN]**

It is recommended that security settings, such as SSID and ENCRYPTION, are specified when using wireless LAN communication. If the security settings are not specified, the contents may be intercepted or it may cause unauthorized access to the system. For details on wireless LAN security settings, refer to **3.1 Projector Web Control**.

**⚠ CAUTION**

► The optional IEEE802.11b/g/n USB wireless adapter uses the 2.4GHz radio frequency band. You do not need a radio license to use the adapter, but you should be aware of the following:

- **DO NOT USE THE USB NEAR THE FOLLOWING!**

- Microwave ovens
- Industrial, scientific or medical devices
- Designated low power radio stations
- Premises radio stations

Using the USB wireless adapter near the above may cause radio interference, which would result in a decrease in transmission speed or interruption, and lead to malfunctioning of devices such as pacemakers.

- Depending on the location where the USB wireless adapter is used, radio wave interference may occur, which may result in a decrease in transmission speed or interruption in communication. In particular, be aware that using the USB wireless adapter at locations where there is reinforced steel, other types of metals or concrete are likely to cause radio wave interference.

- **Available Channels**

The USB wireless adapter uses the 2.4GHz radio frequency band, but depending on the country or region you are in, the channels that you can use might be limited. Consult your dealer for information on the usable channels.

- Bringing the optional USB wireless adapter out of the country or region you reside in and using it there could lead to a violation of the radio laws of that country or region.

**1. Network Function**

This chapter describes the outline of network function.

**1.1 Web Control**

Connecting the projector and the computer using the network, remote control and status monitoring of the projector can be performed by Web browser. Two types of interface, Projector Web Control and Crestron e-Control, are available for this projector. (📖 37)

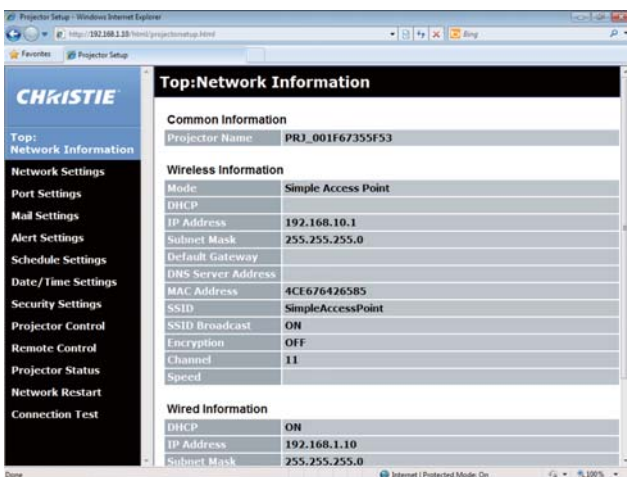

Projector Web Control



Crestron e-Control

**1. Network Function**

**1.2 Network Presentation**

The projector can display or play back the computer screen images and audio data that are transmitted through the network.

To use Network Presentation, an exclusive application, LiveViewer is required. The following application is required to use Network Presentation.

OS	Application
Windows	LiveViewer
iOS(iPhone/iPad)	Christie QuickConnect
Android	Christie QuickConnect

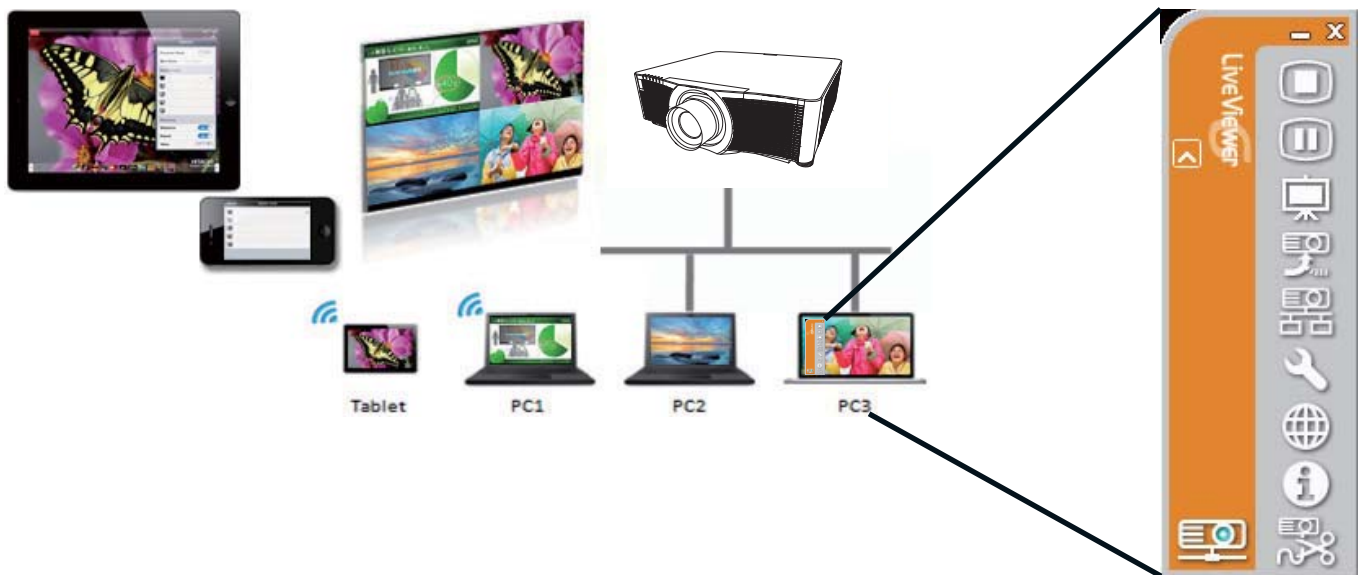



### 1.3 My Image Function

The projector can display still images transferred using the network.

You can allocate up to four image files.

MY IMAGE transmission requires an exclusive application for your computer.

Use the application to transfer the image data.

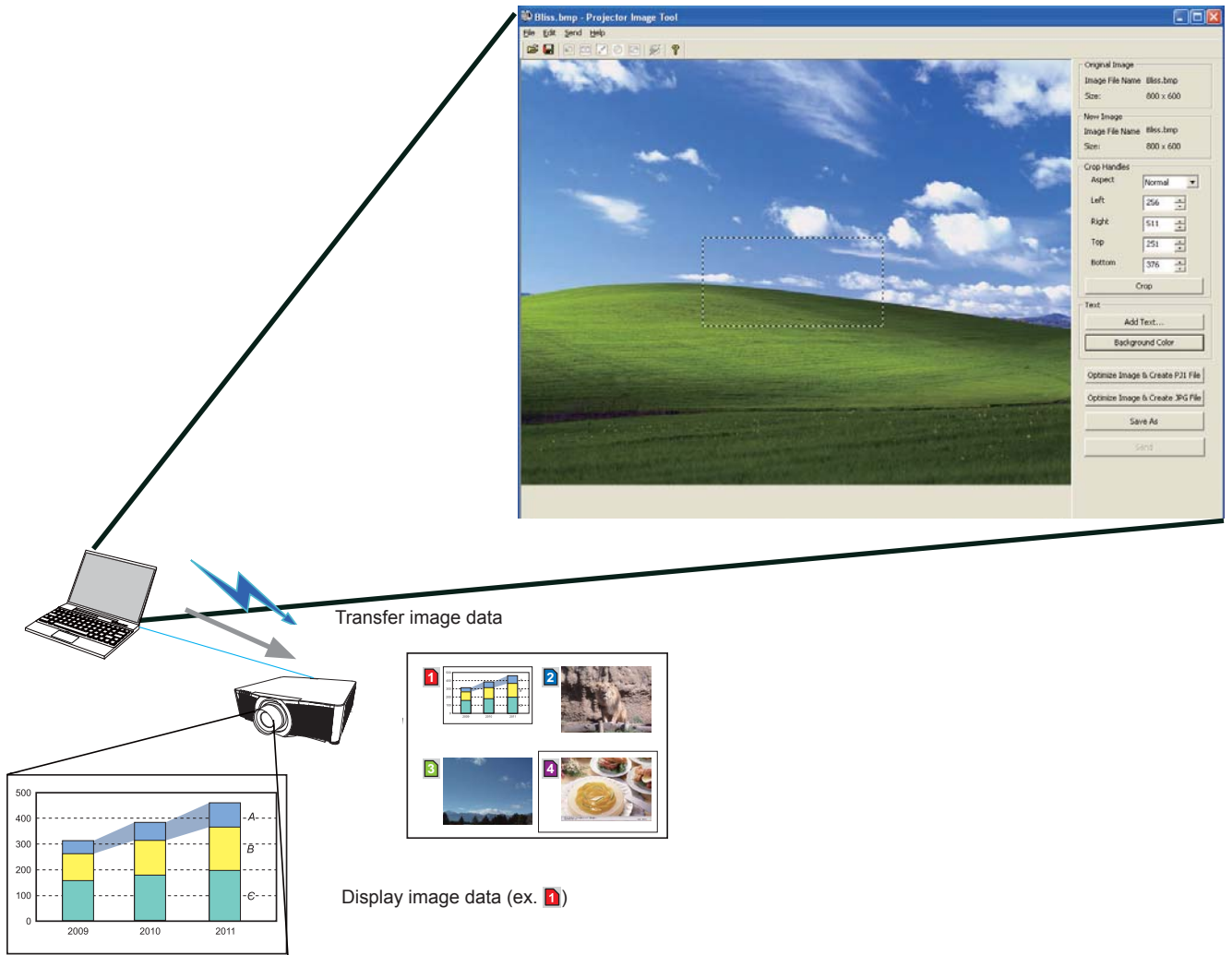

1. Network Function

1.4 Messenger Function

The projector can display text data transferred using the network on the screen and play back audio data inside the projector. Up to 12 text data can be stored.

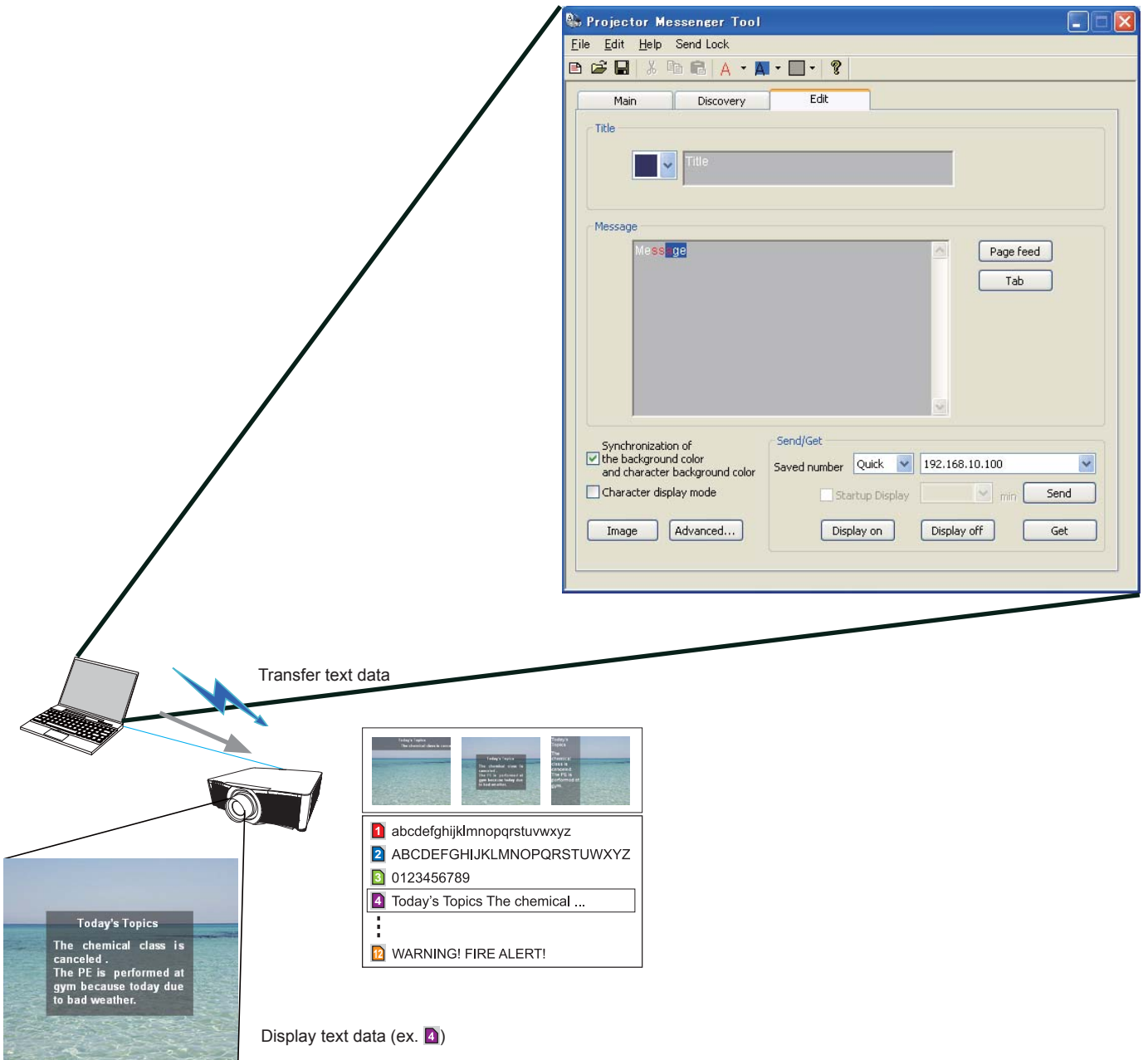

**1.5 Network Bridge Function**

This projector is equipped with the NETWORK BRIDGE function to perform mutual conversion of a network protocol and a serial interface.

By using the NETWORK BRIDGE function, a computer connected to the projector using wireless or wired LAN can control an external device using RS-232C communication using the projector as a network terminal.

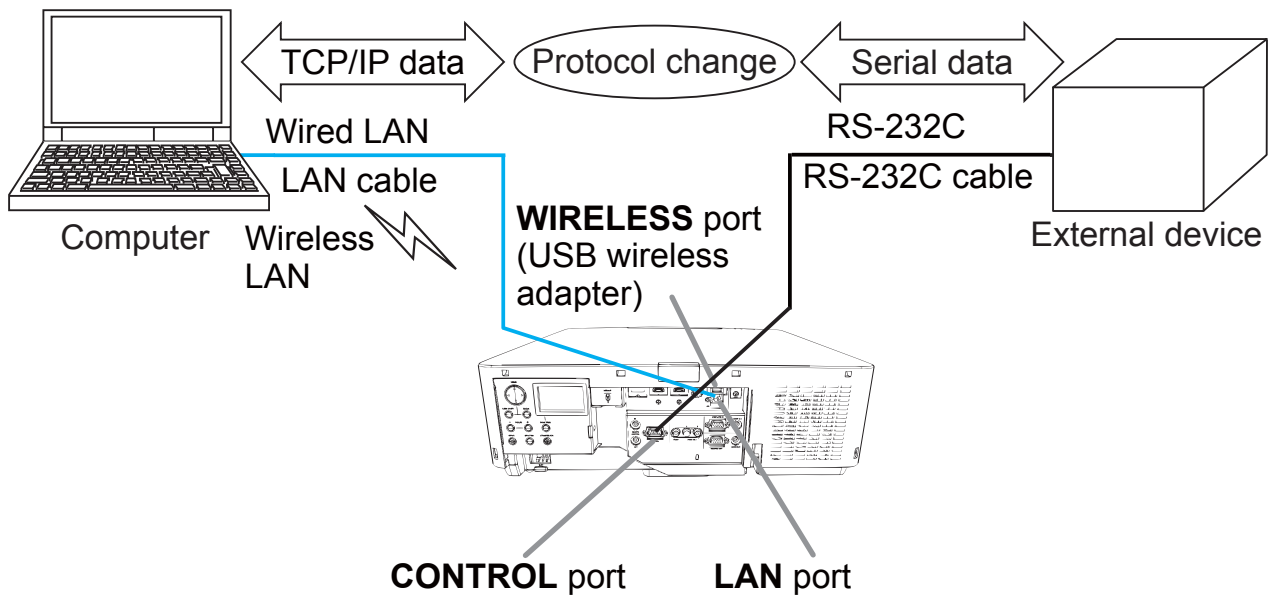

## **1.6 Other Functions**

### **1.6.1 E-mail Alerts**

The projector can automatically send an alert message to the specified using addresses when the projector detects a certain condition requiring maintenance or detected an error. (📖 89)

### **1.6.2 Projector Management using SNMP**

The SNMP (Simple Network Management Protocol) manages the projector information, which is a failure or warning status, from the computer on the network. The SNMP management software is required on the computer to use this function. (📖 92)

### **1.6.3 Event Scheduling**

The scheduling function sets up scheduled events including power on / power off. It allows the projector to be self-managing. The schedule can be set in Projector Web Control or OPTION-SCHEDULE menu in the projector. (📖 94)

### **1.6.4 Command Control via the Network**

You can configure and control the projector using the network using RS-232C commands. (📖 97)

## 2. Connection to the network

### 2.1 System requirements

The following equipment is required to connect the projector to your computer through the network.

- **Common** The projector: 1 unit, Computer: 1 or more sets
- **Connecting device for the projector and the computer**
  - 1) For the wired connection \*1  
LAN cable (CAT-5e or greater): 1 piece
  - 2) For the wireless connection \*2
    - Projector side  
IEEE802.11b/g/n USB wireless adapter (option : USB-WL-11N-NS): 1 unit \*3
    - Computer side  
IEEE802.11b/g/n wireless LAN equipment: 1 unit for each computer \*4

\*1: The system for using the network function of the projector requires a communication environment conforming to 100Base-TX or 10Base-T.

\*2: An access point is required when the wireless LAN connection is used as Infrastructure mode.

\*3: Available encryption methods are as follows. This projector cannot be connected to the wireless network using other encryption method.

	Simple Access Point mode	Infrastructure mode
WPA2-PSK (AES)	✓	✓
WPA2-PSK (TKIP)	✓	✓
WPA-PSK (AES)	✓	✓
WPA-PSK (TKIP)	✓	✓
WEP 128bit	-	✓
WEP 64bit	-	✓

\*4: Depending on the type of wireless network device and computer you are using, the projector may not communicate properly with your computer, even if the computer is equipped with a built-in wireless LAN function.

To eliminate communication problems, use a Wi-Fi certified wireless network device.

- **Web browser**  
Web browser is required to be installed in your computer to use Web control.
- **Application**  
Exclusive applications are required to be installed in your computer to use Network Presentation, My Image and Messenger. (📖 18)

**NOTE** • The network function is not available when STANDBY MODE is set to POWER SAVE and the projector is in standby mode. Connect the projector to the network after setting STANDBY MODE to NORMAL. (📖 SETUP menu in the Operating Guide)

2. Connection to the network

2.2 Connection via wired LAN

The connection using wired LAN is available. Set wired LAN for the projector by following the instructions of your network administrator when connecting to the existing network.

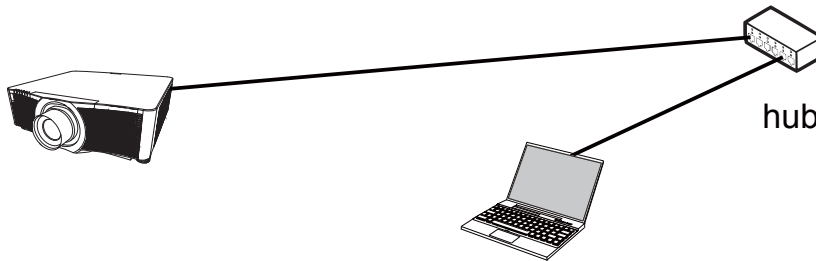

2.3 Connection setup of Wired LAN

- 1) Connect the projector to the computer using a hub with a LAN cable (CAT-5e or higher).
- 2) Press the **MENU** button on the remote control or the control panel of the projector.  
The MENU you last used appears.



Use the cursor button to select the following.

EASY MENU > ADVANCED MENU > NETWORK > WIRED SETUP

- 3) Set the following items in WIRED SETUP.

- DHCP
- IP ADDRESS
- SUBNET MASK
- DEFAULT GATEWAY
- DNS SERVER

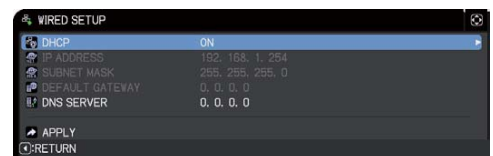

For setting an IP address, refer to About IP address. (📖 13)

Select APPLY, then press the **ENTER** button to apply the settings.

[About IP address]

■ Setting manually

The Network address portion of the IP address setting on your computer must be the same as the setting on the projector. Also, the entire IP address on the computer must not overlap with that of the other devices on the same network, including the projector.

The projector's settings are as follows.

IP address: 192.168.1.254

Subnet mask: 255.255.255.0

(Network address: 192.168.1 in this case)

Therefore, specify the computer's IP address as follows.

IP address: 192.168.1.xxx (xxx shows decimal number)

Subnet mask: 255.255.255.0

(Network address: 192.168.1 in this case)

For example

Select from 1 to 254 for "xxx" without duplicating any other equipment.

In this case, as the IP address of the projector is "192.168.1.254", specify a setting between 1 to 253 for the computer.

■ Setting automatically

When a DHCP server exists in the connected network, it assigns an IP address to the projector and the computer automatically. If DHCP server is not available, set IP ADDRESS, SUBNET MASK and DEFAULT GATEWAY.

**NOTE** • Although **HDBaseT™** and **LAN** port can be used for wired LAN, they cannot be used simultaneously. Connect LAN cable to the port set in WIRED NETWORK on NETWORK menu.

- The same network address cannot be used for both wireless LAN and wired LAN.
- If the projector and the computer exist in the same network (such as same network address), you can leave the default gateway field blank.
- When the projector and the computer exist in different networks, the default gateway must be set. Consult to the network administrator in detail.

2. Connection to the network

**2.4 Connection via wireless LAN**

Connection using wireless LAN is available with option parts, USB wireless adapter (USB-WL-11N-NS).

Wireless LAN has two types of connection, Simple Access Point and Infrastructure.



Fig. 2.4.a Without an access point communication (Simple Access Point)

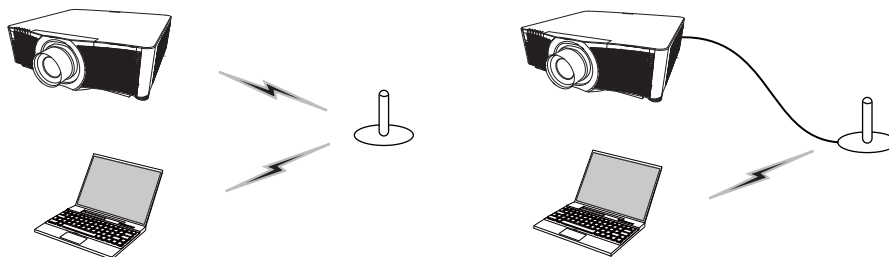

Fig. 2.4.b With an access point communication (Infrastructure)

- \* SIMPLE ACCESS POINT is a mode which connects to computers directly. This projector can assign IP addresses to up to 11 devices.
- \* Infrastructure is one of the wireless LAN communication methods with having an access point to communicate. If communicating with existing network, consult with your network administrator.

**NOTE** • Network settings can also be changed in Network Settings of Projector Web Control.

- Wireless LAN initial settings for the projector are as follows.
  - Mode: Simple Access Point
  - DHCP: Off
  - IP address: 192.168.10.1
  - Subnet Mask: 255.255.255.0
  - Default Gateway: 0.0.0.0
  - DNS SERVER: 0.0.0.0
  - SSID: SimpleAccessPoint ※
  - SSID Broadcast: On
  - Encryption: Off
  - Channel: 11
  - ※ Change default setting before use not to overlap.
- The same network address cannot be used for both wireless LAN and wired LAN.
- Communication speed of the projector may be deteriorated in SIMPLE ACCESS POINT mode depending on the number of connected devices.
- Network communication cannot be available between the devices connected to the projector in SIMPLE ACCESS POINT mode.



**2.4.1 Connection in Simple Access Point Mode**

Set the following when connecting the projector and the computer in Simple Access Point mode.

**Projector setting**

[Restriction on plugging and unplugging the USB wireless adapter]

Before you insert or pull out the USB wireless adapter from the projector, turn off the power of the projector and pull out the power cord’s plug from the outlet. Do not touch the USB wireless adapter that is connected to the projector while the projector is receiving AC power.

Do not use any extension cable or device when connecting the adapter to the projector.

- 1) Attach the USB wireless adapter to the **WIRELESS** port of the projector.
- 2) Turn on the projector.
- 3) Press the **MENU** button on the remote control or the control panel of the projector.  
The MENU you last used appears.

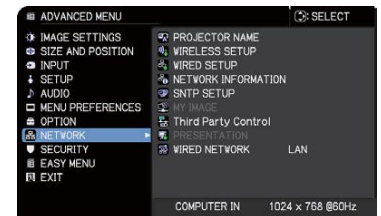

Use the cursor button to select the following.

EASY MENU > ADVANCED MENU > NETWORK > WIRELESS SETUP

- 4) Set the following items in WIRELESS SETUP.
  - MODE: SIMPLE ACCESS POINT
  - IP ADDRESS
  - SSID
  - SSID BROADCAST
  - ENCRYPTION
  - CHANNEL

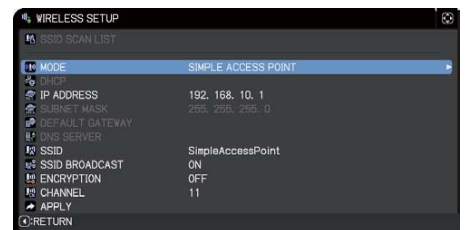

Select APPLY, then press the **ENTER** button to apply the settings.

**About network settings**

- The fourth octet of the projector's IP address is fixed to 1.
- Subnet mask of the projector is fixed to 255.255.255.0.

**Computer setting**

- 1) The DHCP server function of the projector is always enabled. Enable the DHCP setting of the computer.
- 2) Select SSID set for the projector by following the procedure of wireless connection of the computer. Enter encryption key by following the computer’s instruction if it is encrypted.

**NOTE** • As for the procedure of setting network and wireless connection for the computer, refer to the manual of computer or wireless LAN device.

2. Connection to the network

2.4.2 Connection in Infrastructure Mode

Set the following when connecting the projector and the computer in Infrastructure mode.

[Restriction on plugging and unplugging the USB wireless adapter]

Before you insert or pull out the USB wireless adapter from the projector, turn off the power of the projector and pull out the power cord’s plug from the outlet. Do not touch the USB wireless adapter that is connected to the projector while the projector is receiving AC power.

Do not use any extension cable or device when connecting the adapter to the projector.

- 1) Attach the USB wireless adapter to the **WIRELESS** port of the projector.
- 2) Turn on the projector.
- 3) Press the **MENU** button on the remote control or the control panel of the projector.  
The MENU you last used appears.

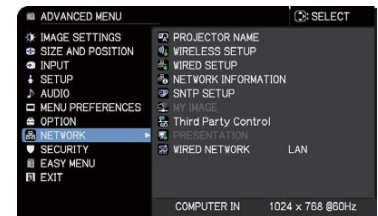

Use the cursor button to select the following.

EASY MENU > ADVANCED MENU > NETWORK > WIRELESS SETUP

- 4) Set the following items in WIRELESS SETUP.

- MODE: INFRASTRUCTURE
- DHCP
- IP ADDRESS
- SUBNET MASK
- DEFAULT GATEWAY
- DNS SERVER
- SSID
- ENCRYPTION

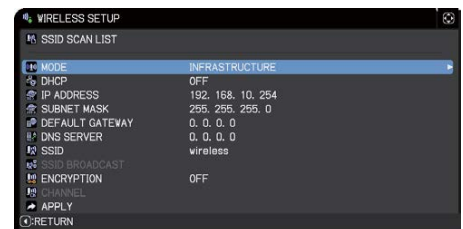

As for setting an IP address, refer to About IP address. (📖 13)

Select APPLY, then press the **ENTER** button to apply the settings.

**Connection in Infrastructure Mode (continued)**

**SSID SCAN LIST function**

The connection can be set up by selecting from SSID SCAN LIST without setting SSID and ENCRYPTION in WIRELESS SETUP. The procedure of connecting by SSID SCAN LIST is as follows.

- 1) Select SSID SCAN LIST in WIRELESS SETUP on NETWORK menu.  
The list of SSID in wireless network is displayed.
- 2) Select SSID in the wireless network you want to connect in the SSID SCAN LIST. The display to enter the encryption key appears if it is encrypted.  
Enter the encryption key by using software keyboard.
- 3) The icon indicating connected () is displayed in SSID SCAN LIST screen when the connection is complete.

**NOTE** • Transmission speed may be slow depending on the settings of an access point.

- If the projector and the computer exist in the same network (such as same network address), leave the default gateway field blank.
- When the projector and the computer exist in different networks, the default gateway must be set. Consult the network administrator for more information.
- Set wireless LAN for the projector by following the instructions of your network administrator when connecting to the existing network.
- Open System Authentication is used for WEP encryption, and Shared Key Authentication is not supported. The authentication with an access point succeeds and it appears that the connection is established normally despite entering illegal an encryption key due to Open System Authentication, but data cannot actually be transmitted.
- IP ADDRESS, SUBNET MASK, and DEFAULT GATEWAY must be set in advance when DHCP is set to OFF.

**2. Connection to the network**

**2.5 Applications**

Download the latest version of the software from the Christie website:

<http://www.christiedigital.com>

For iOS/Android Network Presentation software, refer to the URL below for details and downloads of Christie QuickConnect.

<http://www.christiedigital.com>

**[System Requirements for Applications]**

Application	Hardware and Software
LiveViewer	<p>[Windows]</p> <p>OS:                      Windows Vista® (Service Pack 1 or later)                      Windows 7                      Windows 8/8.1</p> <p>Graphic card:                      VGA: 640x480 or higher (recommended XGA: 1024x768)</p> <p>CPU:                      Pentium 4 (2.8 GHz or higher)</p> <p>Hard disk space:                      100MB or higher</p>

[System Requirements for Applications] (continued)

Application	Hardware and Software
Christie QuickConnect	[iOS] iOS 6 or later  [Android] Android OS 4.0 or later
Projector Image Tool (PJIimg)	OS: Windows Vista® Windows 7 Windows 8/8.1  CPU: Pentium 3 (500MHz or higher)  Hard disk space: 20MB or higher
Projector Messenger Tool (PJMessenger)	OS: Windows Vista® Windows 7 Windows 8/8.1  CPU: Pentium 3 (500MHz or higher)  Hard disk space: 20MB or higher

2. Connection to the network

2.6 NETWORK Menu



Incorrect network settings on this projector may cause trouble on the network. Consult with your network administrator before connecting to an existing access point on your network.

Select NETWORK from the main menu to access to the following functions.

Select an item using the ▲/▼ cursor buttons on the projector or remote control, and press the ► cursor button on the projector or remote control, or **ENTER** button on the remote control to execute the item. Then perform it according to the following table.





- NOTE** • When using a wired LAN, select which function to use, LAN or HDBaseT™, in WIRED NETWORK menu.
- To use the wireless network function of this projector, the designated USB wireless adapter sold as an option is required. Do not use any extension cable or device when connecting the adapter to the projector.
  - The projector does not allow both wireless and wired LAN to be connected to the same network.
  - Do not set the same network address for both wireless and wired LAN.
  - If you do not use SNTP, you must set the DATE AND TIME during the initial installation.
  - The network function is not available when STANDBY MODE is set to POWER SAVE and the projector is in standby mode. Connect the projector to the network after setting STANDBY MODE to NORMAL. (📖SETUP menu in the Operating Guide)

Item	Description
<p><b>PROJECTOR NAME</b></p>	<p>Any name can be set to the projector to identify it on the network.</p>  <p>(1) Select the PROJECTOR NAME and press the ► button. The PROJECTOR NAME dialog is displayed.</p> <p>Use the displayed software keyboard to enter the PROJECTOR NAME.</p> <p>DELETE : Deletes one character.</p> <p>CLEAR ALL: Deletes all characters.</p> <p>CANCEL : Returns to the network menu after discarding the entered characters.</p> <p>OK : Returns to network menu after saving the entered characters.</p> <p>(2) The current PROJECTOR NAME is displayed on the first three lines. The projector name is pre-assigned by default. Use the <b>ENTER</b> or <b>INPUT</b> button to select and enter characters.</p> <p>To erase one character at one time, press the <b>RESET</b> button or press the ◀ and <b>INPUT</b> button at the same time. If you move the cursor to DELETE or CLEAR ALL on screen and push the <b>ENTER</b> or <b>INPUT</b> button, one character or all characters are erased. Up to 64 characters can be entered for the PROJECTOR NAME.</p> <p>(3) To change an already inserted character, move the cursor to one of the first three lines, and move the cursor on the character to be changed.</p>  <p>After pressing the <b>ENTER</b> or <b>INPUT</b> button, the character is selected. Then, follow the same procedure as described at the item (2) above.</p>  <p>(4) To finish entering text, move the cursor to the OK on screen and press the ►, <b>ENTER</b> or <b>INPUT</b> button. To revert to the previous PROJECTOR NAME without saving changes, move the cursor to the CANCEL on screen and press the ◀, <b>ENTER</b> or <b>INPUT</b> button.</p>

(continued on next page)



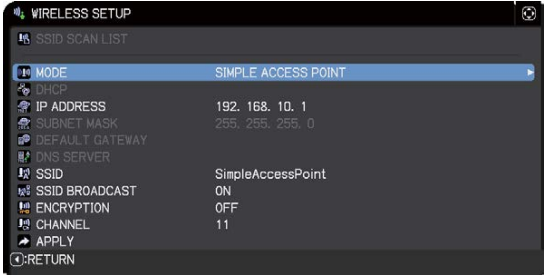









2. Connection to the network

Item	Description	
<p><b>WIRELESS SETUP</b></p>	<p>Configures the wireless network. Setting values are saved after selecting APPLY.</p>  <div style="border: 1px solid black; padding: 5px; margin-top: 10px;"> <p><b>NOTE</b> • Setting values are not saved if Menu disappears before selecting APPLY. • Click APPLY after changing the settings.</p> </div>	
	<p><b>SSID SCAN LIST</b></p>	<p>Searches available wireless network and displays the list of SSID. You can select SSID to connect from the list. (1) SSID on available wireless network is displayed after selecting SSID SCAN LIST and press the ► button.</p>  <div style="border: 1px solid black; padding: 5px; margin-top: 10px;"> <p><b>NOTE</b> • The wireless network using the encryption method not supported by the projector is not displayed in the search list. • An AdHoc network device is not displayed on the SSID SCAN list.</p> </div>

(continued on next page)



Item	Description									
<p><b>WIRELESS SETUP (continued)</b></p>	<p><b>SSID SCAN LIST (continued)</b></p>	<table border="1"> <thead> <tr> <th data-bbox="635 264 794 309">Icon</th> <th data-bbox="794 264 1465 309">Description</th> </tr> </thead> <tbody> <tr> <td data-bbox="639 315 790 389"></td> <td data-bbox="794 315 1460 389">The projector is connecting to the wireless network.</td> </tr> <tr> <td data-bbox="639 396 790 470"></td> <td data-bbox="794 396 1460 470">The wireless network is encrypted.</td> </tr> <tr> <td data-bbox="639 477 790 551"></td> <td data-bbox="794 477 1460 551">The intensity of radio wave.</td> </tr> </tbody> </table>	Icon	Description		The projector is connecting to the wireless network.		The wireless network is encrypted.		The intensity of radio wave.
		Icon	Description							
			The projector is connecting to the wireless network.							
			The wireless network is encrypted.							
	The intensity of radio wave.									
<p>(2) Select the SSID you want to connect and press the ► or <b>ENTER</b> button. The display to enter the encryption key appears if SSID is encrypted. Enter the characters by using software keyboard.</p>										
<p>Move the cursor to OK and press the ►, <b>ENTER</b> or <b>INPUT</b> button after entering.</p>										
 <p><b>NOTE</b> • If you select the [HIDE THE CHARACTERS] checkbox, the characters are hidden.</p>										

(continued on next page)

2. Connection to the network

Item	Description
<p><b>WIRELESS SETUP (continued)</b></p>	<p><b>SSID SCAN LIST (continued)</b></p> <p>(3) The OSD below is displayed while the connection is in progress.</p> <p><b>CONNECTING...</b></p> <p>The keys other than Reset button are not available while the connection is in progress. The connection process is interrupted when pressing the Reset button. The OSD below is displayed when the connection process is complete.</p> <p><b>SUCCEEDED</b> : Connection succeeded</p> <p>The message below is displayed when the connection is not established correctly.</p> <p><b>FAILED</b> : Connection failed</p> <p><b>ENCRYPTION LOCK</b> : Encryption Lock enabled</p> <div style="border: 1px solid black; padding: 10px; margin: 10px 0;"> <p><b>NOTE</b> • Encryption settings cannot be changed when encryption lock is enabled in Network Settings – Wireless Setup in Projector Web Control. Refer to Encryption Lock. (📖 42)</p> <ul style="list-style-type: none"> <li>• Open System Authentication is used for WEP encryption, and Shared Key Authentication is not supported. The authentication with an access point succeeds and it appears that the connection is established normally when entering illegal encryption key due to Open System Authentication, but data cannot actually be transmitted.</li> </ul> </div> <p>(4) The icon indicating the connection status (📶) is displayed in SSID SCAN LIST when the connection is complete.</p>

(continued on next page)

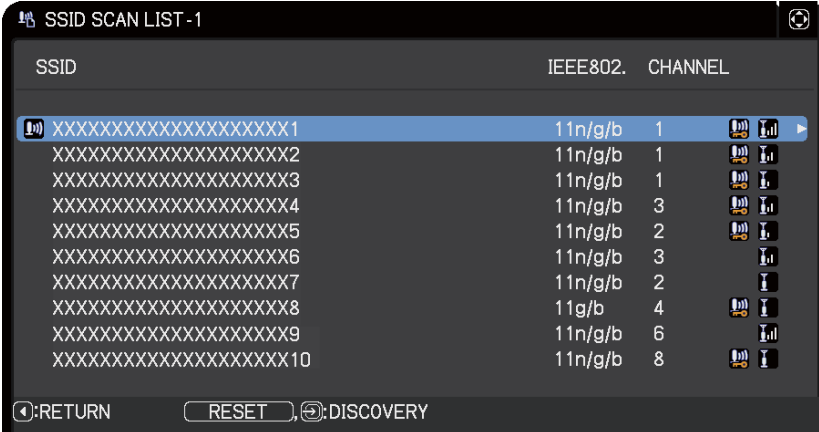
Item	Description	
<p><b>WIRELESS SETUP (continued)</b></p>	<p><b>SSID SCAN LIST (continued)</b></p>	 <p>This function is not available in SIMPLE ACCESS POINT mode.</p>
	<p><b>MODE</b></p>	<p>Switches between SIMPLE ACCESS POINT and INFRASTRUCTURE.                      Select the mode of the network communication system. Select according to the settings of your computer.</p> <p>SIMPLE ACCESS POINT ↔ INFRASTRUCTURE                      To save the setting, press the ► button.</p> <div style="border: 1px solid black; padding: 5px;"> <p><b>NOTE</b> • The setting changed before switching MODE without selecting APPLY is cancelled.                      • When switching MODE, it takes 60 seconds to use the wireless LAN. In the meantime, the operating speed of the projector may be decreased and NETWORK INFORMATION may not be displayed correctly.</p> </div>
	<p><b>DHCP</b></p>	<p>Configures whether IP address is automatically obtained or not.                      Use the ▲/▼ buttons to turn DHCP on/off.                      ON ↔ OFF                      This function is not available in SIMPLE ACCESS POINT mode.</p>

(continued on next page)

2. Connection to the network

Item	Description	
<p><b>WIRELESS SETUP</b> (continued)</p>	<p><b>IP ADDRESS</b></p>	<p>[SIMPLE ACCESS POINT] Refer to Connection in Simple Access Point Mode. (📖 15) [INFRASTRUCTURE] Configures the IP address when DHCP is disabled. Enter the IP ADDRESS. This function can only be used when DHCP is set to OFF.</p>
	<p><b>SUBNET MASK</b></p>	<p>[SIMPLE ACCESS POINT] This setting is fixed to 255.255.255.0. [INFRASTRUCTURE] Configures the subnet mask when DHCP is disabled. Enter the SUBNET MASK. This function can only be used when DHCP is set to OFF.</p>
	<p><b>DEFAULT GATEWAY</b></p>	<p>Configures the default gateway when DHCP is disabled. Enter the DEFAULT GATEWAY address. This function can only be used when DHCP is set to OFF. This function is not available in SIMPLE ACCESS POINT mode.</p>
	<p><b>DNS SERVER</b></p>	<p>Configures the DNS server address. Enter the DNS server address. This function is not available in SIMPLE ACCESS POINT mode.</p> <div style="border: 1px solid black; border-radius: 10px; padding: 5px; margin-top: 10px;"> <p><b>NOTE</b> • This setting cannot be obtained automatically.</p> </div>

(continued on next page)

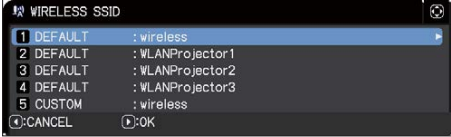
Item	Description	
<p><b>WIRELESS SETUP (continued)</b></p>	<p><b>SSID</b></p>	<p>Configures SSID for wireless network.</p>  <p>[SIMPLE ACCESS POINT] Enter SSID by using software keyboard. Refer to PROJECTOR NAME (📖 21) for how to use software keyboard. Default setting of SSID in Simple Access Point mode is [SimpleAccessPoint]. Change the default setting before using to not overlap.</p> <p>[INFRASTRUCTURE] Select a DEFAULT (#1~#4) and press ► or <b>ENTER</b> button.</p> <p><b>To adjust CUSTOM</b></p> <p>Press the ► or <b>ENTER</b> button when the # 5 CUSTOM is selected. The SSID #5 CUSTOM menu appears. Enter SSID using the software keyboard. Refer to PROJECTOR NAME (📖 21) for how to use software keyboard.</p>

(continued on next page)

2. Connection to the network

Item	Description	
<b>WIRELESS SETUP (continued)</b>	<b>SSID BROADCAST</b>	Configures SSID BROADCAST. Set this function to OFF when the SSID of the projector is not to be displayed in the wireless connection list of the computer.
	<b>ENCRYPTION</b>	Select the encryption method to be used. <div style="text-align: center;">             WPA2-PSK(AES) ⇔ WPA2-PSK(TKIP)              ⬆    ⬆              OFF    WPA-PSK(AES)              ⬆    ⬆              WEP 64bit ⇔ WEP 128bit ⇔ WPA-PSK(TKIP)           </div> WEP 64bit and WEP 128bit are available only in INFRASTRUCTURE mode.  You must enter the encryption key when selecting the encryption method other than OFF and pressing the ► button. <div style="border: 1px solid black; padding: 5px; margin-top: 10px;"> <p><b>NOTE</b> • WPA2-PSK (AES) is recommended for encryption method of IEEE802.11n. Transmission speed in IEEE802.11n may be slow when other encryption method (WEP, WPA-PSK (TKIP), WPA2-PSK (TKIP)). Change the setting to AES if encryption other than AES is set.</p> <ul style="list-style-type: none"> <li>• Encryption method not included in the selected item cannot be available.</li> </ul> </div>
	<b>CHANNEL</b>	Select the channel of the wireless LAN to be used while MODE (📖25) is set to SIMPLE ACCESS POINT. The channels 1 to 11 are available. To save the setting, press the ► button. • The available channels vary depending on a country.

(continued on next page)

Item	Description	
<b>WIRED SETUP</b>	<p>Configures wired network. Setting values are saved after selecting APPLY.</p>  <div style="border: 1px solid black; padding: 5px; margin-top: 10px;"> <p><b>NOTE</b> • Setting values are not saved if Menu disappears before selecting APPLY.</p> <p>• Execute APPLY after changing the settings.</p> </div>	
	<b>DHCP</b>	<p>Configures whether the IP address is automatically obtained or not.</p> <p>Use the ▲/▼ buttons to turn DHCP on/off.</p> <p>ON ⇔ OFF</p>
	<b>IP ADDRESS</b>	<p>Configures the IP address when DHCP is disabled. Enter the IP ADDRESS.</p> <p>This function can only be used when DHCP is set to OFF.</p>
	<b>SUBNET MASK</b>	<p>Configures the subnet mask when DHCP is disabled. Enter the SUBNET MASK.</p> <p>This function can only be used when DHCP is set to OFF.</p>
	<b>DEFAULT GATEWAY</b>	<p>Configures the default gateway when DHCP is disabled. Enter the DEFAULT GATEWAY address.</p> <p>This function can only be used when DHCP is set to OFF.</p>
	<b>DNS SERVER</b>	<p>Configures the DNS server address. Enter the DNS server address.</p> <div style="border: 1px solid black; padding: 5px; margin-top: 10px;"> <p><b>NOTE</b> • This setting cannot be obtained automatically.</p> </div>

(continued on next page)

2. Connection to the network

Item	Description	
<p><b>NETWORK INFORMATION</b></p>	<p>Selecting this item displays the dialog for viewing the wireless and wired LAN settings. Use the ▲/▼ buttons to switch the page. The first page shows the wireless LAN settings. The second page is for the wired LAN settings, and the third page is for common setting item.</p>	
	<p><b>WIRELESS INFORMATION</b></p>	<p>The following information is displayed.</p> <ul style="list-style-type: none"> <li>· PASSCODE</li> <li>· MODE</li> <li>· IP ADDRESS</li> <li>· SUBNET MASK</li> <li>· DEFAULT GATEWAY</li> <li>· DNS SERVER</li> <li>· MAC ADDRESS</li> <li>· SSID</li> <li>· SSID BROADCAST</li> <li>· ENCRYPTION</li> <li>· CHANNEL</li> <li>· SPEED</li> </ul> <p>Passcord supports the connection between the projector and the computer when using Network Presentation. Refer to Network Presentation (📖 77) for the details.</p> <div style="border: 1px solid black; padding: 10px;"> <p><b>NOTE</b> • IP ADDRESS, SUBNET MASK and DEFAULT GATEWAY indicate “0.0.0.0” in the following condition.</p> <p>(1) The USB wireless adapter is not inserted into the projector.</p> <p>(2) DHCP is ON and the projector does not get address from DHCP server.</p> <ul style="list-style-type: none"> <li>• Nothing (blank) is shown in the CHANNEL and SPEED fields if the USB wireless adapter is not inserted.</li> </ul> </div>

(continued on next page)





Item	Description	
<p><b>NETWORK INFORMATION (continued)</b></p>	<p><b>WIRED INFORMATION</b></p>	<p>The following information is displayed.</p> <ul style="list-style-type: none"> <li>· PASSCODE</li> <li>· IP ADDRESS</li> <li>· SUBNET MASK</li> <li>· DEFAULT GATEWAY</li> <li>· DNS SERVER</li> <li>· MAC ADDRESS</li> </ul> <p>Passcord enables the projector and the computer to be connected to the network easily when using Network Presentation. Refer to Network Presentation (📖 77) for details.</p> <div style="border: 1px solid black; padding: 5px; margin-top: 10px;"> <p><b>NOTE</b> • IP ADDRESS, SUBNET MASK and DEFAULT GATEWAY indicate 0.0.0.0 when DHCP is ON and the projector has not gotten address from DHCP server.</p> </div>
	<p><b>OTHER INFORMATION</b></p>	<p>The following information is displayed.</p> <ul style="list-style-type: none"> <li>· PROJECTOR NAME</li> <li>· DATE AND TIME</li> <li>· SNTP SERVER</li> <li>· TIME DIFFERENCE</li> </ul> <p>• PROJECTOR NAME and SNTP SERVER may appear truncated if too long.</p>

(continued on next page)

**2. Connection to the network**

Item	Description	
<p><b>SNTP SETUP</b></p>	<p><b>SNTP SERVER</b></p>	<p>When you get the time using the network, specify SNTP server with IP address or domain name. Up to 255 characters can be entered for the domain name.</p> <p>Enter the characters using the software keyboard. Refer to PROJECTOR NAME(📖 21) for how to use software keyboard.</p> <div style="border: 1px solid black; border-radius: 10px; padding: 5px;"> <p><b>NOTE</b> • Set the time difference when using SNTP.</p> </div>
	<p><b>TIME DIFFERENCE</b></p>	<p>Enter the time difference. Set the same time difference as the one set on your computer. If unsure, consult your network administrator. Use the ► button to return to the menu after setting the TIME DIFFERENCE.</p>

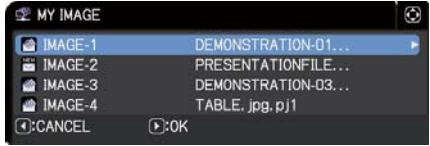
(continued on next page)

Item	Description
<p><b>MY IMAGE</b></p>	<p>Selecting this item displays the MY IMAGE menu. Use the application to transfer the image data. It can be downloaded from the web site.</p>  <p>Refer to 5. My Image Function (📖 81) for the details of MY IMAGE.</p> <p>Select an item of still image by the MY IMAGE and press the ► or <b>ENTER</b> button to display the image.</p> <ul style="list-style-type: none"> <li>• An item without a stored image cannot be selected.</li> <li>• Each image name is displayed in 16 characters or less.</li> </ul> <p><b>To switch the image displayed</b> Use the ▲/▼ buttons.</p> <p><b>To return to the menu</b> Press the ◀ button on the remote control.</p> <p><b>To erase the displayed image and its source file in the projector.</b></p> <p>(1) Press the <b>RESET</b> button on the remote control while displaying an image to display the MY IMAGE DELETE menu.</p>  <p>(2) Press the ► button to erase. To stop erasing, press the ◀ button.</p>

(continued on next page)

**2. Connection to the network**

Item	Description	
<b>Third Party Control</b>	<b>AMX D.D. (AMX Device Discovery)</b>	<p>Use the ▲/▼ buttons to turn the AMX Device Discovery on/off. ON ⇔ OFF</p> <p>When ON is selected, the projector can be detected by controllers of AMX connected to the same network. For the details of AMX Device Discovery, visit the AMX web site. <u>URL: <a href="http://www.amx.com/">http://www.amx.com/</a></u></p>
	<b>CRESTRON</b>	<p>Use the ▲/▼ buttons to turn the Crestron Connected™ on/off. ON ⇔ OFF</p> <p>When ON is selected, controlling and managing the projector can be performed by using the controllers of Crestron connected to the same network. For the details of Crestron Connected™, visit the following web site. <u>URL: <a href="http://www.crestron.com/">http://www.crestron.com/</a></u></p>
	<b>EXTRON</b>	<p>Use the ▲/▼ buttons to turn the Extron on/off. ON ⇔ OFF</p> <p>When ON is selected, the controllers of Extron connected using HDBaseT™ can detect the projector. For the details of Extron, visit the following web site. <u>URL: <a href="http://www.extron.com/">http://www.extron.com/</a></u></p> <div style="border: 1px solid black; border-radius: 10px; padding: 10px; margin-top: 10px;"> <p><b>NOTE</b> • This item is enabled only when HDBaseT is selected in WIRED NETWORK.</p> </div>

(continued on next page)

Item	Description	
<b>PRESENTATION</b>	<p>To use Network Presentation, an exclusive application is required. It can be installed from the bundled application CD. You can also download the latest version and relevant information from the Christie website.</p> <p>Refer to 4. Network Presentation (📖 77) for the details of Network Presentation.</p>	
	<b>QUIT PRESENTER MODE</b>	<p>If you set a computer to the Presenter mode while its image is projected, the projector is occupied by the computer and access from any other computer is blocked.</p> <p>Use this function to quit the Presenter mode and allow other computers to access the projector. Select this item to display a dialog. Press the ► button to choose OK in the dialog. The Presenter mode is cancelled and a message is displayed indicating the result.</p>
	<b>MULTI PC MODE</b>	<p>If setting one or more computers to the Multi PC mode and send their images to the projector, you can select the display mode on the projector from two options below.</p> <ul style="list-style-type: none"> <li>- Single PC mode: displays the image of the selected computer on full screen.</li> <li>- Multi PC mode: displays the images sent from up to four computers on screen that is divided into quarter sections.</li> </ul> <p>Select this item to display a dialog. Use the dialog to change the display mode as explained below.</p> <ul style="list-style-type: none"> <li>• To change from Multi PC mode to Single PC mode, select one of computers in the dialog using the ▲/▼/◀/▶ buttons and press the <b>ENTER</b> or <b>INPUT</b> button.</li> </ul> <p>Press the ► button to choose OK, and then press <b>ENTER</b> or <b>INPUT</b> again. The image for the selected computer is displayed on full screen.</p> <p>(continued on next page)</p>

(continued on next page)

**2. Connection to the network**

Item	Description	
<p><b>PRESENTATION (continued)</b></p>	<p><b>MULTI PC MODE (continued)</b></p>	<ul style="list-style-type: none"> <li>• To change from Single PC mode to Multi PC mode, press the ► button to choose OK in the dialog and press the <b>ENTER</b> or <b>INPUT</b> button. The display mode is changed.</li> <li>• The Presenter mode setting of the selected computer becomes valid when the display mode is changed to Single PC mode. Also, the Presenter mode setting becomes invalid when the display mode is changed to Multi PC mode, regardless of the setting on the computers.</li> </ul>
	<p><b>DISPLAY USER NAME</b></p>	<p>Selecting this item displays the user name. This function helps you identify from which computer the current image is sent.</p>
<p><b>WIRED NETWORK</b></p>	<p>Selects whether to use <b>LAN</b> or <b>HDBaseT™</b> port. LAN ⇄ HDBaseT</p> <div style="border: 1px solid black; border-radius: 10px; padding: 10px; margin-top: 10px;"> <p><b>NOTE</b> • Only the <b>LAN</b> or <b>HDBaseT</b> port can be used for the connection to the network. Switch it according to the environment.</p> </div>	

**3. Web Control**

You can adjust or control the projector using a network from a web browser on a computer connected to the same network.

■ **Projector Web Control**

You can control the projector, collect the status such as lamp time, and set email or schedule, and so on in Projector Web Control.

Recommended web browser

- Internet Explorer® 8/ 9/ 10/ 11

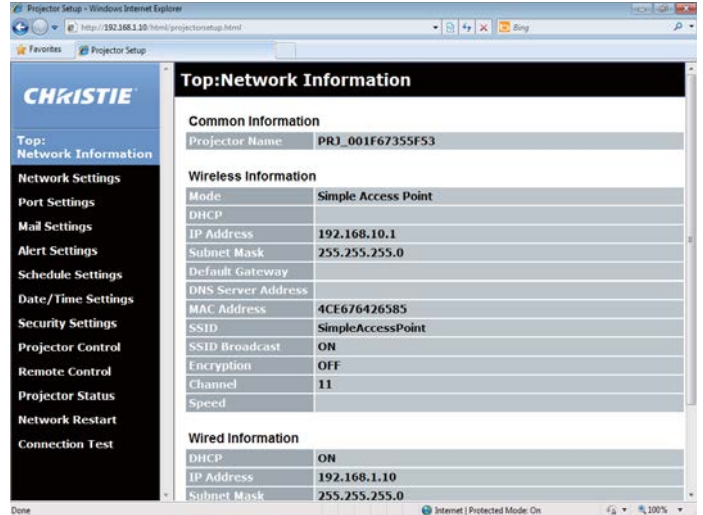

**NOTE** • Web browsers other than recommended ones may not work.

- If JavaScript® is disabled in your web browser configuration, you must enable JavaScript® to use the projector web pages properly. See the Help files for your web browser for details on how to enable JavaScript®.
- It is recommended that all web browser updates are installed.
- If data is transferred using wireless and wired LAN at the same time, the projector may not process the data correctly.

■ **Crestron e-Control**

Crestron e-Control® is a control interface using a web browser provided by Crestron Electronics, Inc. Crestron e-Control® can control and monitor the projector.



(continued on next page)

3. Web Control

**NOTE** • Crestron e-Control® is created using Flash®. You must install Adobe® Flash® Player on your computer to use Crestron e-Control®. Crestron e-Control® is not displayed in a web browser that does not support Flash®.

• The selection window does not appear but the Login window of the Projector Web Control is displayed. For the following:

- Network Settings - Other Setup - Crestron e-Control is Disable (📖 45)
- Network Settings - Common Setup - Crestron is OFF (📖 42)
- NETWORK menu - Third Party Control - CRESTRON is OFF (📖 34)

Refer to the following for configuring or controlling the projector using a web browser.

Make sure that your computer and the projector is connected using network, and then start Web browser.

Enter the projector's IP address into URL input box of the Web browser as the example below, and then press the Enter key or  button.

**Example:** If the IP address of the projector is set to **192.168.1.10**:

Enter “**http://192.168.1.10/**” into the address bar of the web browser and press the Enter key or click  button.

If a correct URL is input, and the projector and your computer are connected to the same network correctly, the selection window is displayed.

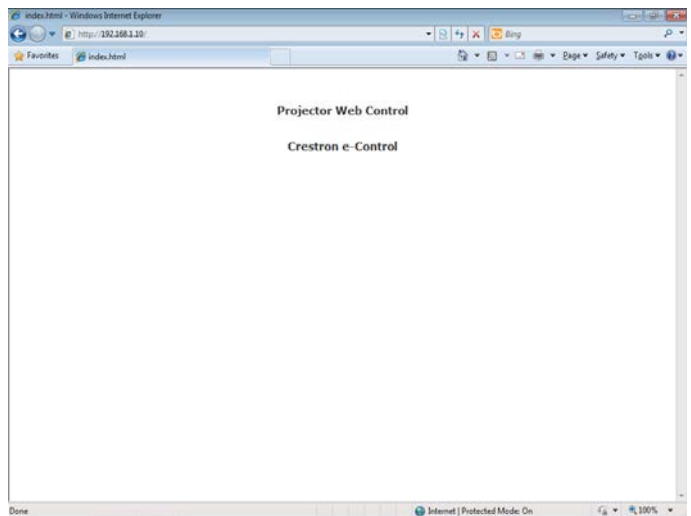

**NOTE** • Do not control the projector with the projector's menu or remote control, and the Web Control at the same time. It may cause some operational errors in the projector.

• The language used on the Projector Web Control is the same as that of the OSD on the projector. If you want to change it, you must change the OSD language on the projector. (📖 MENU PREFERENCES in the Operating Guide)



## 3.1 Projector Web Control

### 3.1.1 Login

To use the Projector Web Control function, you must login with your user name and password.

Below are the factory default settings for the user name and password.

<b>User name</b>	Administrator
<b>Password</b>	<blank>

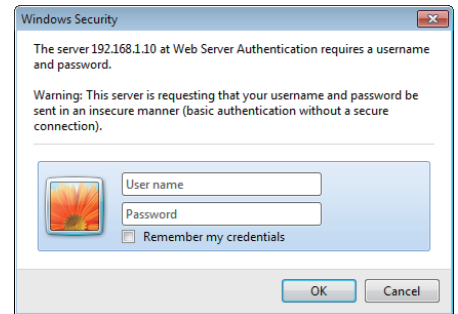

Login window

Enter your user name and password, and click **[OK]**. If you login successfully, the screen below is displayed.

Main menu

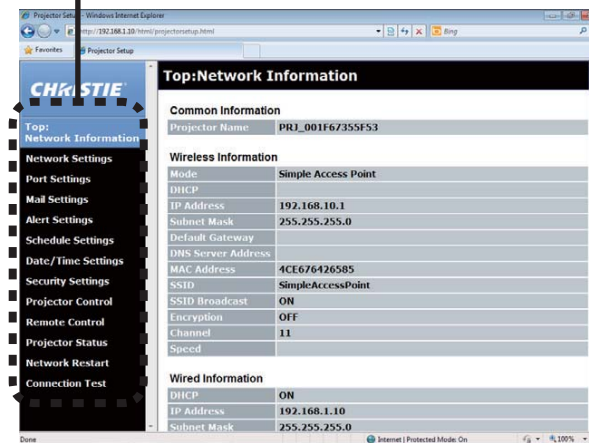

Click the required operation or configuration item on the main menu.

3. Web Control

3.1 Projector Web Control (continued)

3.1.2 Network Information

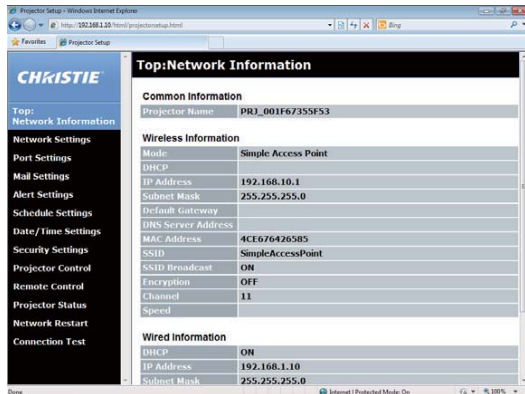

Displays the projector’s current network configuration settings.

Item	Description
<b>Common Information</b>	Displays information common to both wireless and wired LAN.
<b>Projector Name</b>	Displays the projector name settings.
<b>Wireless Information</b>	Displays the current settings of wireless LAN.
<b>Mode</b>	Displays the mode of wireless LAN communication.
<b>DHCP</b>	Displays the DHCP setting.
<b>IP Address</b>	Displays the IP address.
<b>Subnet Mask</b>	Displays the subnet mask.
<b>Default Gateway</b>	Displays the default gateway.
<b>DNS Server Address</b>	Displays the DNS server address.
<b>MAC Address</b>	Displays the MAC address.
<b>SSID</b>	Displays the SSID used by the projector.
<b>SSID Broadcast</b>	Displays the SSID Broadcast used by the projector.
<b>Encryption</b>	Displays the data encryption setting.
<b>Channel</b>	Displays the channel used for wireless LAN.
<b>Speed</b>	Displays the current wireless LAN transmission speed.
<b>Wired Information</b>	Displays the current wired LAN settings.
<b>DHCP</b>	Displays the DHCP setting.
<b>IP Address</b>	Displays the IP address.
<b>Subnet Mask</b>	Displays the subnet mask.
<b>Default Gateway</b>	Displays the default gateway.
<b>DNS Server Address</b>	Displays the DNS server address.
<b>MAC Address</b>	Displays the MAC address.

### 3.1 Projector Web Control (continued)

#### 3.1.3 Network Settings

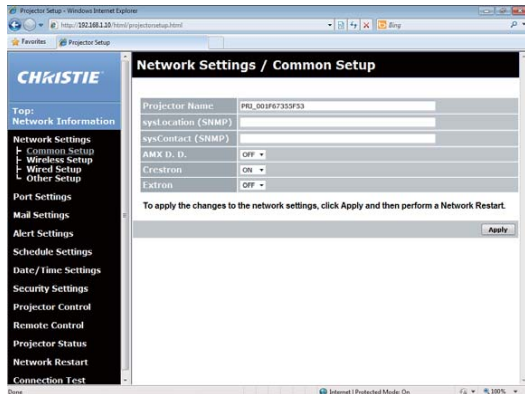

Displays and configures network settings.

Item	Description
<b>Common Setup</b>	Configures the settings common to wireless and wired LAN.
<b>Projector Name</b>	Configures the name of the projector. The length of the Projector Name can be up to 64 alphanumeric characters. Only alphabets, numbers and following symbols can be used. ! "\$ % & ' ( ) * + , - . / : ; < = > ? @ [ \ ] ^ _ {   } ~ and space. Particular projector name is pre-assigned by default.
<b>sysLocation (SNMP)</b>	Configures the location to be referred to when using SNMP. The length of the sysLocation can be up to 255 alphanumeric characters. Only numbers '0-9', alphabet 'a-z' and 'A-Z' can be used.
<b>sysContact (SNMP)</b>	Configures the contact information to be referred to when using SNMP. The length of the sysContact can be up to 255 alphanumeric characters. Only numbers '0-9', alphabet 'a-z' and 'A-Z' can be used.
<b>AMX D.D. (AMX Device Discovery)</b>	Configures the AMX Device Discovery setting to detect the projector from the controllers of AMX connected to the same network. For the details of AMX Device Discovery, visit the AMX web site. <u>URL: <a href="http://www.amx.com">http://www.amx.com</a></u>

(continued on next page)

3. Web Control

3.1 Projector Web Control - Network Settings (continued)

Item	Description
<p><b>Common Setup (continued)</b></p>	<p>Configures the settings common to wireless and wired LAN.</p>
<p><b>Crestron</b></p>	<p>Configures the Crestron setting to detect the projector from the controllers of Crestron connected to the same network. For the details of Crestron, visit the Crestron web site.            URL: <a href="http://www.crestron.com">http://www.crestron.com</a></p>
<p><b>Extron</b></p>	<p>Configures the Extron setting to detect the projector from the controllers of Extron connected to the same network using <b>HDBaseT™</b> port. For the details of Extron, visit the Extron web site.            URL: <a href="http://www.extron.com">http://www.extron.com</a></p> <div style="border: 1px solid black; border-radius: 10px; padding: 5px;"> <p><b>NOTE</b> • This item is enabled only when HDBaseT is selected in WIRED NETWORK. (📖 36)</p> </div>
<p><b>Wireless Setup</b></p>	<p>Configures the wireless LAN settings.</p>
<p><b>Mode</b></p>	<p>Select Simple Access Point or Infrastructure.</p> <div style="border: 1px solid black; border-radius: 10px; padding: 5px;"> <p><b>NOTE</b> • When switching MODE, it takes 60 seconds to use wireless LAN. In the meantime, the operating speed of the projector may be decreased and NETWORK INFORMATION may not be displayed correctly.</p> </div>
<p><b>Encryption Lock</b></p>	<p>Permits or inhibits changes of the following settings related to wireless connection.</p> <ul style="list-style-type: none"> <li>• Mode</li> <li>• SSID</li> <li>• SSID Broadcast</li> <li>• Encryption</li> <li>• Encryption key (WEP key, WPA passphrase)</li> </ul> <p>When Encryption Lock is set to ON, these settings cannot be changed by the menu of the projector.</p> <div style="border: 1px solid black; border-radius: 10px; padding: 5px;"> <p><b>NOTE</b> • If Encryption Lock is ON, wireless connection is performed only when it can be connected without changing the current settings.</p> </div>

(continued on next page)

**3.1 Projector Web Control - Network Settings (continued)**

Item	Description
<b>Wireless Setup (continued)</b>	Configures the wireless LAN settings.
<b>Simple Access Point settings</b>	Configures Simple Access Point mode.
<b>IP Configuration</b>	Configures network settings.
<b>IP Address</b>	Configures the IP address.
<b>Subnet Mask</b>	Subnet mask of the projector is fixed to 255.255.255.0.
<b>SSID</b>	Input SSID. The maximum number of input characters is 32. Only alphabets, numbers and the following symbols can be used. !"#\$%&'()*+,-./:;<=>?@[\\]^_`{ }~ and space. Default setting of SSID in Simple Access Point mode is [SimpleAccessPoint]. Change default setting before use not to overlap.
<b>SSID Broadcast</b>	Select SSID Broadcast. Set this function to OFF when indicating the SSID of a projector is not displayed in the wireless connection list of the computer.
<b>Encryption</b>	Select data encryption method.
<b>WPA Passphrase</b>	Input WPA Passphrase. Available number of input characters is 8 to 63. Only alphabets, numbers and the following symbols can be used. !"#\$%&'()*+,-./:;<=>?@[\\]^_`{ }~ and space
<b>Channel</b>	Select from “1” to “11”, a channel to use in the Simple Access Point mode. <div style="border: 1px solid black; padding: 5px; margin-top: 10px;"> <p><b>NOTE</b> • The channels may vary depending on the country. In addition, depending on the country or region, it may be required to use a wireless network card that conforms to the standards in the respective country or region.</p> </div>

(continued on next page)

**3. Web Control**

**3.1 Projector Web Control - Network Settings (continued)**

Item	Description									
<b>Wireless Setup (continued)</b>	Configures the wireless LAN settings.									
<b>Infrastructure settings</b>	Configures Infrastructure mode.									
<b>IP Configuration</b>	Configures network settings.									
<b>DHCP ON</b>	Enables DHCP.									
<b>DHCP OFF</b>	Disables DHCP.									
<b>IP Address</b>	Configures the IP address when DHCP is disabled.									
<b>Subnet Mask</b>	Configures the subnet mask when DHCP is disabled.									
<b>Default Gateway</b>	Configures the default gateway when DHCP is disabled.									
<b>DNS Server Address</b>	Configures the DNS server address.									
<b>SSID</b>	Select an SSID from the list. If you require to set your unique SSID, select <b>[Custom]</b> , then set your own SSID following the rules below. The maximum number of input characters is 32. Only alphabets, numbers and the following symbols can be used. !"#\$%&'()*+,-./:;<=>?@[ \ ] ^ _ { } ~ and space.									
<b>Encryption</b>	Select data encryption method.									
<b>WEP Key</b>	Input the WEP key. Either ASCII characters or hexadecimal numbers can be used during WEP key input. However, you cannot use a combination of both. The length of the key is defined as follows according to the WEP and character formats.									
	<table border="1"> <thead> <tr> <th>Encryption</th> <th>ASCII characters</th> <th>HEX numbers</th> </tr> </thead> <tbody> <tr> <td>WEP 64bit</td> <td>5 characters</td> <td>10 characters</td> </tr> <tr> <td>WEP 128bit</td> <td>13 characters</td> <td>26 characters</td> </tr> </tbody> </table>	Encryption	ASCII characters	HEX numbers	WEP 64bit	5 characters	10 characters	WEP 128bit	13 characters	26 characters
Encryption	ASCII characters	HEX numbers								
WEP 64bit	5 characters	10 characters								
WEP 128bit	13 characters	26 characters								
<b>WPA Passphrase</b>	Input WPA Passphrase. Available number of input characters is 8 to 63. Only alphabets, numbers and the following symbols can be used. !"#\$%&'()*+,-./:;<=>?@ [ \ ] ^ _ { } ~ and space									

(continued on next page)

**3.1 Projector Web Control - Network Settings (continued)**

Item	Description
<b>Wired Setup</b>	Configures the wired LAN settings.
<b>IP Configuration</b>	Configures network settings.
<b>DHCP ON</b>	Enables DHCP.
<b>DHCP OFF</b>	Disables DHCP.
<b>IP Address</b>	Configures the IP address when DHCP is disabled.
<b>Subnet Mask</b>	Configures the subnet mask when DHCP is disabled.
<b>Default Gateway</b>	Configures the default gateway when DHCP is disabled.
<b>DNS Server Address</b>	Configures the DNS server address.
<b>Other Setup</b>	Configures other network settings.
<b>Crestron e-Control</b>	Set whether or not to use Crestron e-Control®. If you choose Disable, the Login window of Projector Web Control is displayed first.

Click the **[Apply]** button to save the settings.

**NOTE** • The new configuration settings are activated after restarting the network connection. When the configuration settings are changed, you must restart the network connection. You can restart the network connection from Network Restart on the main menu. (📖 66)

- If you connect the projector to an existing network, consult a network administrator before setting server addresses.
- The WEP Key, WPA passphrase and SSID settings are not set if the invalid characters are used.
- The projector does not allow both wireless and wired LAN to be connected to the same network. Do not set the same network address for both wireless and wired LAN.



3. Web Control

3.1 Projector Web Control (continued)

3.1.4 Port Settings

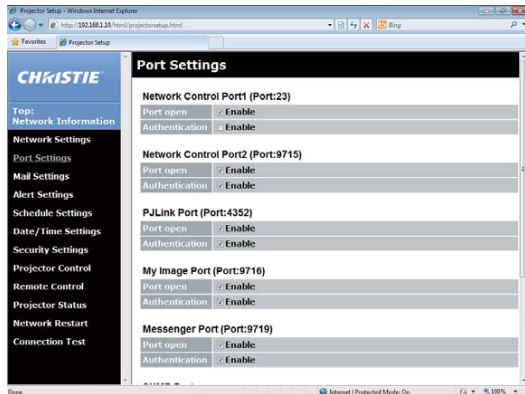

Displays and configures communication port settings.

Item	Description
<b>Network Control Port1 (Port:23)</b>	Configures command control port 1 (Port:23).
<b>Port open</b>	Click the <b>[Enable]</b> checkbox to use port 23.
<b>Authentication</b>	Click the <b>[Enable]</b> checkbox when authentication is required for this port.
<b>Network Control Port2 (Port:9715)</b>	Configures command control port 2 (Port:9715).
<b>Port open</b>	Click the <b>[Enable]</b> checkbox to use port 9715.
<b>Authentication</b>	Click the <b>[Enable]</b> checkbox when authentication is required for this port.
<b>PJLink™ Port (Port:4352)</b>	Configures the PJLink™ port (Port:4352).
<b>Port open</b>	Click the <b>[Enable]</b> checkbox to use port 4352.
<b>Authentication</b>	Click the <b>[Enable]</b> checkbox when authentication is required for this port.
<b>My Image Port (Port:9716)</b>	Configures the My Image Port (Port:9716).
<b>Port open</b>	Click the <b>[Enable]</b> checkbox to use port 9716.
<b>Authentication</b>	Click the <b>[Enable]</b> checkbox when authentication is required for this port.
<b>Messenger Port (Port:9719)</b>	Configures the Messenger Port (Port:9719).
<b>Port open</b>	Click the <b>[Enable]</b> checkbox to use port 9719.
<b>Authentication</b>	Click the <b>[Enable]</b> checkbox when authentication is required for this port.

(continued on next page)



**3.1 Projector Web Control - Port Settings (continued)**

Item	Description
<b>SNMP Port</b>	Configures the mib file port.
<b>Port open</b>	Click the <b>[Enable]</b> checkbox to use SNMP.
<b>Trap address</b>	Configures the destination of the SNMP Trap in IP format. • The address allows not only IP address but also domain name if the valid DNS server is setup in the <b>Network Settings</b> . The maximum length of host or domain name is up to 255 characters.
<b>Download MIB file</b>	Downloads a MIB file from the projector.
<b>Network Bridge Port</b>	Configures the Bridge port number.
<b>Port number</b>	Input the port number. Except for 41794, 9715, 9716, 9719, 9720, 5900, 5500, 4352 between 1024 and 65535 can be set up. It is set to 9717 as the default setting.

Click the **[Apply]** button to save the settings.

**NOTE** • The new configuration settings are activated after restarting the network connection. When the configuration settings are changed, you must restart the network connection. You can restart the network connection from Network Restart on the main menu. (📖 66)

3. Web Control

3.1 Projector Web Control (continued)

3.1.5 Mail Settings

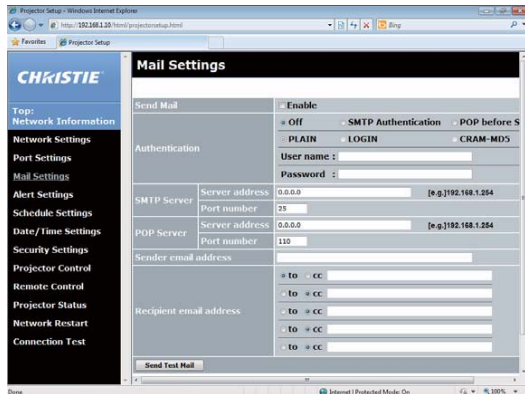

Displays and configures email addressing settings.

Item	Description
<b>Send Mail</b>	Click the <b>[Enable]</b> checkbox to use the email function. Configure the conditions for sending email under the <b>Alert Settings</b> .
<b>Authentication</b>	Selects the authentication method. Enter the user name of the SMTP server or POP server as the user name. Enter the password of the SMTP server or POP server as the password. The maximum number of input characters is 63. Only alphabets, numbers and the following symbols can be used. !"#%&'()*+,-./:;<=>?@[\\]^_`{ }~ and space.
<b>SMTP Server</b>	Configures the SMTP server.
<b>Server address</b>	Configures the SMTP server address. • The address allows not only IP address but also domain name if the valid DNS server is setup in the <b>Network Settings</b> . The maximum length of host or domain name is up to 255 characters. Alphanumeric characters, "-", or "." can be used.
<b>Port number</b>	Configures the port number of the SMTP server. It is set to 25 as the default setting.
<b>POP Server</b>	Configures the POP server.
<b>Server address</b>	Configures the POP server address. • The address allows both the IP address and domain name if the valid DNS server is setup in the <b>Network Settings</b> . The maximum length of host or domain name is up to 255 characters. Alphanumeric characters, "-", or "." can be used.
<b>Port number</b>	Configures the port number of the POP server. It is set to 110 as the default setting.

(continued on next page)

**3.1 Projector Web Control - Mail Settings (continued)**

Item	Description
<b>Sender email address</b>	Configures the sender email address. The length of the sender email address can be up to 255 alphanumeric characters.
<b>Recipient email address</b>	Configures the email address of up to five recipients. You can also specify the <b>[to]</b> or <b>[cc]</b> for each address. The length of the recipient email address can be up to 255 alphanumeric characters.
<b>Send Test Mail</b>	Sends a test email to the set address.

Click the **[Apply]** button to save the settings.

Mail settings are initialized when clicking the **[Reset]** button.

**NOTE** • You can confirm whether the mail settings work correctly by using the **[Send Test Mail]** button. Enable Send Mail setting before clicking the **[Send Test Mail]**.

- If you connect the projector to an existing network, consult a network administrator before setting server addresses.

**3. Web Control**

**3.1 Projector Web Control (continued)**

**3.1.6 Alert Settings**

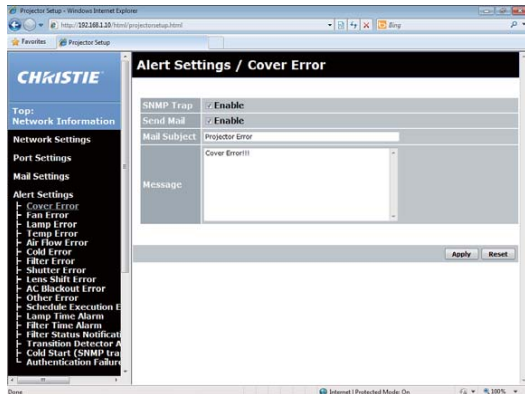

Displays and configures failure & alert settings.

Notification such as email and SNMP trap can be set regarding the following errors/warnings.

- Cover Error
- Fan Error
- Lamp Error
- Temp Error
- Air Flow Error
- Cold Error
- Filter Error
- Shutter Error
- Lens Shift Error
- AC Blackout Error
- Other Error
- Schedule Execution Error
- Lamp Time Alarm
- Filter Time Alarm
- Filter Status Notification
- Transition Detector Alarm
- Cold Start
- Authentication Failure

Refer to Chapter 8-1 for the details of the above errors/warnings. (📖 89)

**3.1 Projector Web Control - Alert Settings (continued)**

The Alert Items are shown below.

Item	Description
<b>Alarm Time</b>	Configures the time to alert. (Only <b>Lamp Time Alarm</b> and <b>Filter Time Alarm</b> .)
<b>SNMP Trap</b>	Click the <b>[Enable]</b> checkbox to enable SNMP Trap alerts.
<b>Send Mail</b>	Click the <b>[Enable]</b> checkbox to enable email alerts. (Except <b>Cold Start</b> and <b>Authentication Failure</b> .)
<b>Mail Subject</b>	Configures the subject line of the email to be sent. The length of the subject line can be up to 100 alphanumeric characters. Using any other character may shorten the subject line. (Except <b>Cold Start</b> and <b>Authentication Failure</b> .)
<b>Message</b>	Configures the message of the email to be sent. The length of the message is up to 1024 alphanumeric characters. Using any other character may shorten the message. (Except <b>Cold Start</b> and <b>Authentication Failure</b> .)

Click the **[Apply]** button to save the settings.

The settings are initialized when clicking the **[Reset]** button.

3. Web Control

3.1 Projector Web Control (continued)

3.1.7 Schedule Settings

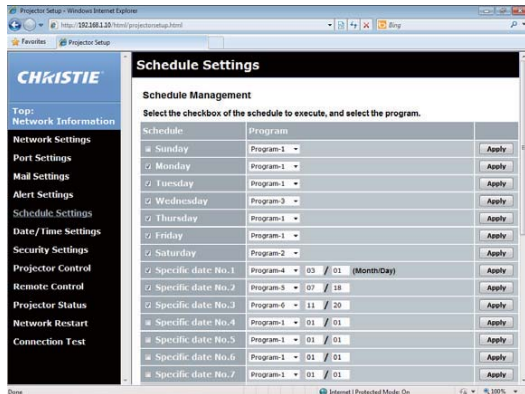

Displays and configures schedule settings.

**NOTE** • Be sure to set the date and time before enabling scheduled events. (📖 56)  
 • Refer to 8.3 Event Scheduling for the details of schedule settings. (📖 94)

1) Schedule Management

Item	Description
<b>Sunday</b>	Schedule settings executed on each day of the week.
<b>Monday</b>	
<b>Tuesday</b>	
<b>Wednesday</b>	
<b>Thursday</b>	
<b>Friday</b>	
<b>Saturday</b>	
<b>Specific date No.1</b>	Schedule settings executed on specified day. Up to 10 days can be specified.
<b>Specific date No.2</b>	
<b>Specific date No.3</b>	
<b>Specific date No.4</b>	
<b>Specific date No.5</b>	
<b>Specific date No.6</b>	
<b>Specific date No.7</b>	
<b>Specific date No.8</b>	
<b>Specific date No.9</b>	
<b>Specific date No.10</b>	

**3.1 Projector Web Control - Schedule Settings (continued)**

Item	Description
<b>Schedule</b>	Select the checkbox of the schedule to execute.
<b>Program</b>	Select the program. The detail of the event registered in each program can be confirmed in the program list displayed at the bottom of the screen.
<b>Date (Month/Day)</b>	Input the date (month/day) when the schedule is executed for Specific date 1~10.

Click the **[Apply]** button to save the settings.

Click the **[Refresh]** button to update the screen to the latest status.

Click the **[Program Edit]** button to display the program edit of the selected program.

Click the **[Copy to]** button to copy the content of the program from which you copy (the list on the left) to the program to which you copy (the list on the right). The same program number cannot be selected for both the program from which and the program to which you copy.

3. Web Control

3.1 Projector Web Control - Schedule Settings (continued)

2) Program Edit

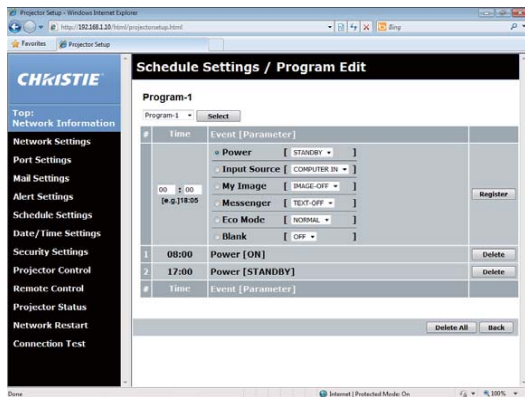

The current event settings are displayed on the list. To add additional functions and events, set the following items.

**NOTE** • A maximum of 16 programs of schedule can be set. A maximum of 20 events can be registered in one program.

Item	Description
<b>Time</b>	Configures the time to execute events.
<b>Event [Parameter]</b>	Configures the events to be executed.
<b>Power</b>	Configures the parameters for power control.
<b>STANDBY</b>	
<b>ON</b>	
<b>Input Source</b>	Configures the parameters for switching input.
<b>COMPUTER IN</b>	
<b>HDMI 1</b>	
<b>HDMI 2</b>	
<b>DisplayPort</b>	
<b>HDBaseT</b>	
<b>SDI (LWU701i only)</b>	
<b>VIDEO</b>	Configures the parameters for My Image data display.
<b>LAN</b>	
<b>My Image</b>	
<b>IMAGE-OFF</b>	
<b>IMAGE-1</b>	
<b>IMAGE-2</b>	
<b>IMAGE-3</b>	
<b>IMAGE-4</b>	



**3.1 Projector Web Control - Schedule Settings (continued)**

Item	Description														
<table border="1"> <tr> <td data-bbox="167 353 553 398"><b>Messenger</b></td> <td data-bbox="553 344 1482 1059" rowspan="13">Configures the parameters for Messenger data display.</td> </tr> <tr> <td data-bbox="245 398 553 450">TEXT-OFF</td> </tr> <tr> <td data-bbox="245 450 553 501">TEXT-1</td> </tr> <tr> <td data-bbox="245 501 553 553">TEXT-2</td> </tr> <tr> <td data-bbox="245 553 553 604">TEXT-3</td> </tr> <tr> <td data-bbox="245 604 553 656">TEXT-4</td> </tr> <tr> <td data-bbox="245 656 553 707">TEXT-5</td> </tr> <tr> <td data-bbox="245 707 553 759">TEXT-6</td> </tr> <tr> <td data-bbox="245 759 553 810">TEXT-7</td> </tr> <tr> <td data-bbox="245 810 553 862">TEXT-8</td> </tr> <tr> <td data-bbox="245 862 553 913">TEXT-9</td> </tr> <tr> <td data-bbox="245 913 553 965">TEXT-10</td> </tr> <tr> <td data-bbox="245 965 553 1016">TEXT-11</td> </tr> <tr> <td data-bbox="245 1016 553 1059">TEXT-12</td> </tr> </table>	<b>Messenger</b>	Configures the parameters for Messenger data display.	TEXT-OFF	TEXT-1	TEXT-2	TEXT-3	TEXT-4	TEXT-5	TEXT-6	TEXT-7	TEXT-8	TEXT-9	TEXT-10	TEXT-11	TEXT-12
<b>Messenger</b>	Configures the parameters for Messenger data display.														
TEXT-OFF															
TEXT-1															
TEXT-2															
TEXT-3															
TEXT-4															
TEXT-5															
TEXT-6															
TEXT-7															
TEXT-8															
TEXT-9															
TEXT-10															
TEXT-11															
TEXT-12															
<table border="1"> <tr> <td data-bbox="167 1068 553 1113"><b>Eco Mode</b></td> <td data-bbox="553 1059 1482 1211" rowspan="2">Configures the parameters for eco mode switching.</td> </tr> <tr> <td data-bbox="245 1113 553 1158">NORMAL</td> </tr> <tr> <td data-bbox="245 1158 553 1211">ECO</td> <td data-bbox="553 1211 1482 1211"></td> </tr> </table>	<b>Eco Mode</b>	Configures the parameters for eco mode switching.	NORMAL	ECO											
<b>Eco Mode</b>	Configures the parameters for eco mode switching.														
NORMAL															
ECO															
<table border="1"> <tr> <td data-bbox="167 1220 553 1265"><b>Blank</b></td> <td data-bbox="553 1211 1482 1364" rowspan="2">Configures the parameters for blank screen on/off control.</td> </tr> <tr> <td data-bbox="245 1265 553 1310">OFF</td> </tr> <tr> <td data-bbox="245 1310 553 1364">ON</td> <td data-bbox="553 1364 1482 1364"></td> </tr> </table>	<b>Blank</b>	Configures the parameters for blank screen on/off control.	OFF	ON											
<b>Blank</b>	Configures the parameters for blank screen on/off control.														
OFF															
ON															

Click the **[Register]** button to add new events to the program.

Click the **[Delete]** button to delete events from the program.

Click the **[Delete All]** button to clear all the events registered in the current selected program.

Click the **[Back]** button to go back to the schedule management screen.

3. Web Control

3.1 Projector Web Control (continued)

3.1.8 Date/Time Settings

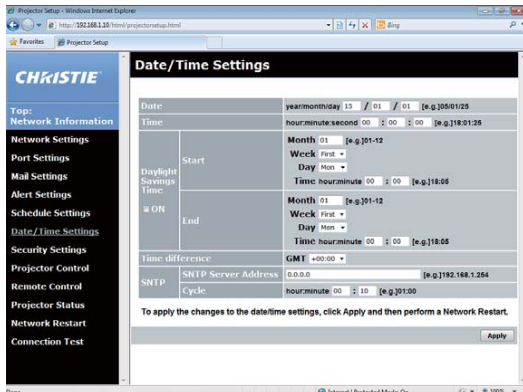

Displays and configures the date and time settings.

Item	Description
<b>Date</b>	Configures the current date in <b>year/month/day</b> format.
<b>Time</b>	Configures the current time in <b>hour:minute:second</b> format.
<b>Daylight Savings Time</b>	Click the <b>[ON]</b> checkbox to enable daylight savings time and set the following items.
<b>Start</b>	Configures the date and time daylight savings time begins.
<b>Month</b>	Configures the month daylight savings time begins (1~12).
<b>Week</b>	Configures the week of the month daylight savings time begins (First, 2, 3, 4, Last).
<b>Day</b>	Configures the day of the week daylight savings time begins (Sun, Mon, Tue, Wed, Thu, Fri, Sat).
<b>Time</b>	<b>hour</b> Configures the hour daylight savings time begins (0 ~ 23).
	<b>minute</b> Configures the minute daylight savings time begins (0 ~ 59).
<b>End</b>	Configures the date and time daylight savings time ends.
<b>Month</b>	Configures the month daylight savings time ends (1 ~ 12).
<b>Week</b>	Configures the week of the month daylight savings time ends (First, 2, 3, 4, Last).
<b>Day</b>	Configures the day of the week daylight savings time ends (Sun, Mon, Tue, Wed, Thu, Fri, Sat).
<b>Time</b>	<b>hour</b> Configures the hour daylight savings time ends (0 ~ 23).
	<b>minute</b> Configures the minute daylight savings time ends (0 ~ 59).

(continued on next page)

**3.1 Projector Web Control - Date/Time Settings (continued)**

Item		Description
<b>Time difference</b>		Configures the time difference. Set the same time difference as the one set on your computer. If unsure, consult your IT manager.
<b>SNTP</b>	<b>SNTP Server Address</b>	Configures the SNTP server address in IP format. <ul style="list-style-type: none"> <li>• The address allows not only IP address but also domain name if the valid DNS server is setup in the Network Settings. The maximum length of host or domain name is up to 255 characters.</li> </ul>
	<b>Cycle</b>	Configures the interval at which to retrieve Date and Time information from the SNTP server ( <b>hour:minute</b> ).

Click the **[Apply]** button to save the settings.

**NOTE** • The new configuration settings are activated after restarting the network connection. When the configuration settings are changed, you must restart the network connection. You can restart the network connection from Network Restart on the main menu. (📖 66)

- If you connect the projector to an existing network, consult a network administrator before setting server addresses.
- To enable the SNTP function, the time difference must be set.
- The projector retrieves Date and Time information from the time server and override time settings when SNTP is enabled.
- The internal clock's time may not remain accurate. Using SNTP is recommended to maintain accurate time.
- The internal battery is required to be replaced when the time is off soon after setting date and time.

3. Web Control

3.1 Projector Web Control (continued)

3.1.9 Security Settings

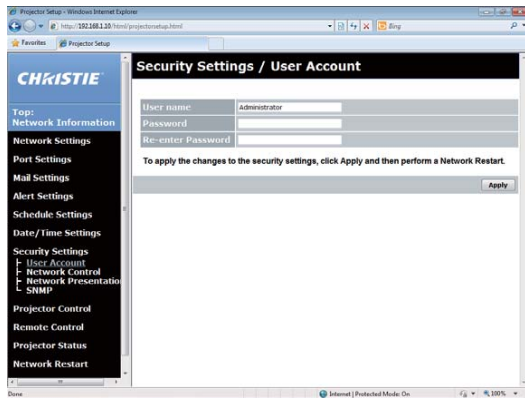

Displays and configures passwords and other security settings.

Item	Description
<b>User Account</b>	Configures the user name and password.
<b>User name</b>	Configures the user name. The length of the text can be up to 32 alphanumeric characters.
<b>Password</b>	Configures the password. The length of the text can be up to 255 alphanumeric characters.
<b>Re-enter Password</b>	Reenter the above password for verification.
<b>Network Control</b>	Configures the Authentication password for Network Control Port1 (Port: 23), Network Control Port2 (Port: 9715), PJLink™ Port (Port: 4352), My Image Port (Port: 9716), and Messenger Port (Port: 9719). (📖 46)
<b>Authentication Password</b>	Configures the Authentication password. The length of the text can be up to 32 alphanumeric characters.
<b>Re-enter Authentication Password</b>	Reenter the above password for verification.
<b>Network Presentation</b>	Setting an authentication password used in Network Presentation. The authentication function is disabled when an authentication password is not set.
<b>Authentication Password</b>	Configures the Authentication password. The length of the text can be up to 15 alphanumeric characters.
<b>Re-enter Authentication Password</b>	Reenter the above password for verification.

(continued on next page)

**3.1 Projector Web Control - Security Settings (continued)**

Item	Description		
<b>SNMP</b>	Configures the community name if SNMP is used.		
<table border="1"> <tr> <td data-bbox="165 369 539 452"><b>Community name</b></td> <td data-bbox="539 369 1485 452">Configures the community name. The length of the text can be up to 64 alphanumeric characters.</td> </tr> </table>	<b>Community name</b>	Configures the community name. The length of the text can be up to 64 alphanumeric characters.	
<b>Community name</b>	Configures the community name. The length of the text can be up to 64 alphanumeric characters.		

Click the **[Apply]** button to save the settings.

**NOTE** • The new configuration settings are activated after restarting the network connection. When the configuration settings are changed, you must restart the network connection. You can restart the network connection from Network Restart on the main menu. (📖 66)

- Only numbers 0-9, alphabet a-z and A-Z can be used.

3. Web Control

3.1 Projector Web Control (continued)

3.1.10 Projector Control

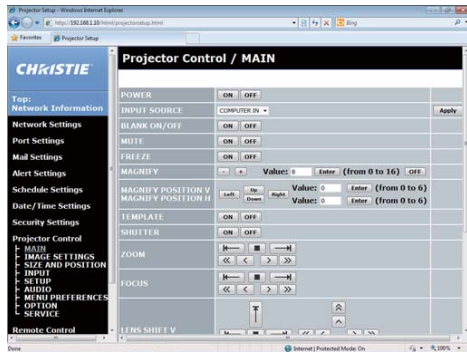

Operations of the projector can be performed with the items on the screen. The categories of the items are shown in the main menu. Most of the items have a submenu. Refer to the table below for details.

**NOTE** • The setting value may not match with the actual value if the user changes the value manually. In that case, refresh the page by clicking the [Refresh] button.

Item	
MAIN	<b>POWER</b>
	<b>INPUT SOURCE</b>
	<b>BLANK ON/OFF</b>
	<b>MUTE</b>
	<b>FREEZE</b>
	<b>MAGNIFY</b>
	<b>MAGNIFY POSITION V</b>
	<b>MAGNIFY POSITION H</b>
	<b>TEMPLATE</b>
	<b>SHUTTER</b> [ON]: closed / [OFF]: opened
	<b>ZOOM</b> [←] / [→]: Turns the lens to the upper or lower limit of its movable range. [■]: Stops turning the lens. [⏪] / [⏩] / [⏴] / [⏵]: Fine adjustment in two steps is available.
	<b>FOCUS</b> [←] / [→]: Turns the lens to the upper or lower limit of its movable range. [■]: Stops turning the lens. [⏪] / [⏩] / [⏴] / [⏵]: Fine adjustment in two steps is available.
	<b>LENS SHIFT V</b> <b>LENS SHIFT H</b> [←] / [→]: Turns the lens to the upper or lower limit of its movable range. [■]: Stops turning the lens. [⏪] / [⏩] / [⏴] / [⏵]: Vertical and horizontal fine adjustment in two steps is available.

(continued on next page)

**3.1 Projector Web Control - Projector Control (continued)**

Item	
<b>MAIN (continued)</b>	<b>LENS MEMORY</b>
	<b>WINDOW CONFIGURATION - OFF / PbyP / PIP</b> Click the [Apply] button to execute after selecting the display mode (OFF/ PbyP/ PIP) from the list. Click the [Edit] button to display the screen for detailed settings while PbyP or PIP display mode.
	<b>MY IMAGE</b>
	<b>MY IMAGE DELETE</b>
<b>IMAGE SETTINGS</b>	<b>PICTURE QUALITY</b>
	<b>PICTURE MODE</b>
	<b>GAMMA</b>
	<b>COLOR TEMP</b>
	<b>eClarity</b>
	<b>HDCR</b>
	<b>Advanced Color Adjustment</b>
	<b>BRIGHTNESS</b>
	<b>CONTRAST</b>
	<b>COLOR</b>
	<b>TINT</b>
	<b>SHARPNESS</b>
<b>DYNAMIC IRIS</b>	
<b>MY MEMORY</b>	
<b>SIZE AND POSITION</b>	<b>ASPECT</b> The selected parameter cannot be set depending on the input signal.
	<b>OVER SCAN</b>
	<b>V POSITION</b>
	<b>H POSITION</b>
	<b>H PHASE</b>
	<b>H SIZE</b>
	<b>AUTO IMAGE</b>
<b>INPUT</b>	<b>PROGRESSIVE</b>
	<b>VIDEO NR</b>
	<b>COLOR SPACE</b>
	<b>VIDEO FORMAT</b>
	<b>DIGITAL FORMAT</b>
	<b>DIGITAL RANGE</b>
	<b>COMPUTER IN</b>
<b>FRAME LOCK</b>	

(continued on next page)

**3. Web Control**

**3.1 Projector Web Control - Projector Control (continued)**

Item			
SETUP	KEYSTONE	KEYSTONE V KEYSTONE H	
	3D KEYSTONE	SETUP - Corner Position/Line Distortion	
	WARPING	MODE	
	EDGE BLENDING	MODE	MODE
		BLENDING LEVEL	BLENDING LEVEL
		BLENDING REGION	BLENDING REGION
		CROPPING	CROPPING
		Dimming Level	Dimming Level
		WHITE BALANCE GAIN	WHITE BALANCE GAIN
	LAMP & FILTER	WHITE BALANCE OFFSET	WHITE BALANCE OFFSET
		BLACK LEVEL	BLACK LEVEL
	LAMP & FILTER	ECO MODE	ECO MODE
		FILTER MESSAGE	FILTER MESSAGE
	HDCR LiteLoc		
	PICTURE POSITION		
	INSTALLATION		
STANDBY MODE			
<div style="border: 1px solid black; padding: 5px;"> <p><b>NOTE</b> • The network function is not available when STANDBY MODE is set to POWER SAVE and the projector is in standby mode. Connect the projector to the network after setting STANDBY MODE to NORMAL.</p> </div>			
OSD MESSAGE			
AUDIO	VOLUME	VOLUME	
	SPEAKER	SPEAKER	
	AUDIO SOURCE	AUDIO SOURCE	

(continued on next page)



**3.1 Projector Web Control - Projector Control (continued)**

Item	
<b>MENU PREFERENCES</b>	<p><b>LANGUAGE</b> Click the <b>[Apply]</b> button to switch the language on the Web screen according to the setting of the selected language in the projector.</p>
	<p><b>MENU POSITION V</b> <b>MENU POSITION H</b></p>
	<p><b>BLANK</b></p>
	<p><b>AUTO BLANK</b></p>
	<p><b>START UP</b></p>
	<p><b>My Screen Lock</b></p>
	<p><b>TEMPLATE</b></p>
	<p><b>Closed Caption C.C. - DISPLAY</b></p>
	<p><b>Closed Caption C.C. - MODE</b></p>
	<p><b>Closed Caption C.C. - CHANNEL</b></p>
<b>OPTION</b>	<p><b>SOURCE SKIP</b></p>
	<p><b>AUTO SEARCH</b></p>
	<p><b>DIRECT POWER ON</b></p>
	<p><b>AUTO POWER OFF</b></p>
	<p><b>SHUTTER TIMER</b></p>
	<p><b>MY BUTTON – 1 / 2 / 3 / 4</b></p>
	<p><b>REMOTE RECEIV.</b></p>
	<p><b>REMOTE FREQ.</b></p>
<b>SERVICE</b>	<p><b>Quit Presenter Mode</b> Quit compulsorily from the Presenter mode. Refer to Chapter 4 for the details of Presenter Mode. (📖 77)</p>

3. Web Control

3.1 Projector Web Control (continued)

3.1.11 Remote Control

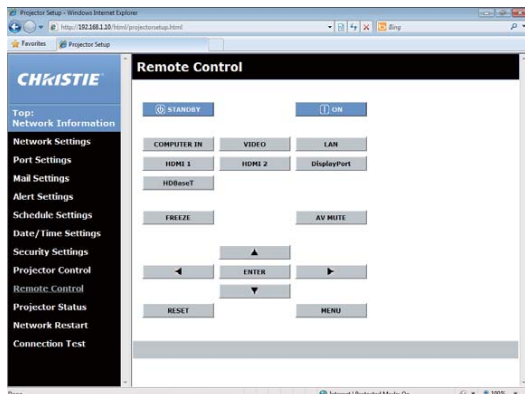

LWU601i/LWU651i/LW751i/LX801i

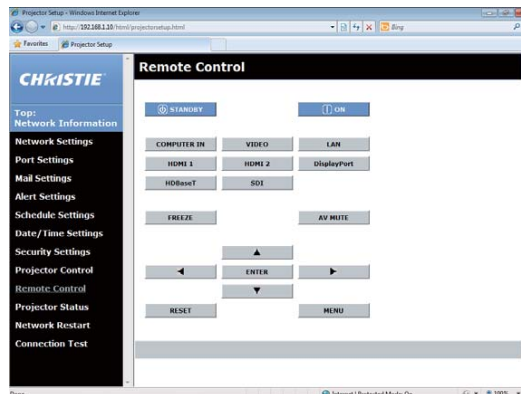

LWU701i

The functions on the bundled remote control are assigned to the Web Remote Control screen.

Do not control the projector with the projector's remote control and using the Web Remote Control at the same time. It may cause some operational errors in the projector.

- STANDBY
- ON
- COMPUTER IN
- HDMI 1
- HDMI 2
- DisplayPort
- HDBaseT
- SDI (LWU701i only)
- VIDEO
- LAN
- AV MUTE
- FREEZE
- ▲ / ▼ / ◀ / ▶
- ENTER
- MENU
- RESET

**NOTE** • A single operation can be performed with one click. The button should be clicked repeatedly to operate continuously.

- When clicking the button repeatedly, some commands may not be sent correctly. Click it at intervals.
- When the [STANDBY] or [ON] button is pushed, a message window comes up to confirm the operation. To control the power, push [OK], otherwise push [Cancel].

**3.1 Projector Web Control (continued)**

**3.1.12 Projector Status**

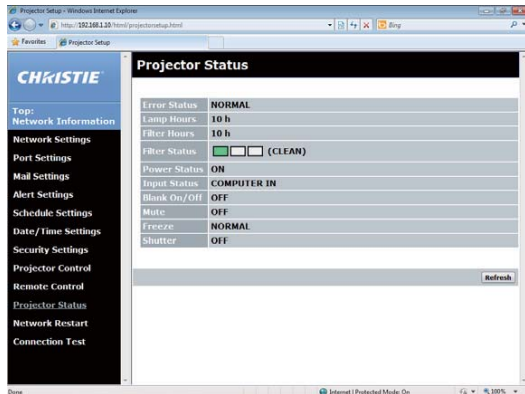

Displays the current settings and status of the projector.

Item	Description
<b>Error Status</b>	Displays the error status.
<b>Lamp Hours</b>	Displays the usage time for the lamp.
<b>Filter Hours</b>	Displays the usage time for the filter.
<b>Filter Status</b>	Displays the current cleanliness level of the air filter.
<b>Power Status</b>	Displays the power status.
<b>Input Status</b>	Displays the input signal source.
<b>Blank On/Off</b>	Displays the Blank screen on/off status.
<b>Mute</b>	Displays the Mute on/off status.
<b>Freeze</b>	Displays the Freeze status.
<b>Shutter</b>	Displays the shutter status.

3. Web Control

3.1 Projector Web Control (continued)

3.1.13 Network Restart

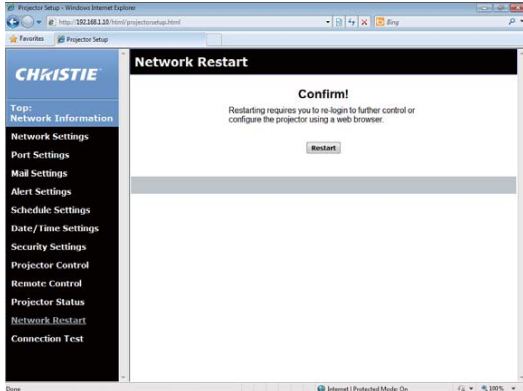

Restarts the projector’s network connection.

Item	Description
Restart	Restarts the projector’s network connection to activate new configuration settings.

**NOTE** • Restarting requires you to re-login to further control or configure the projector using a web browser. Wait 30 seconds or more after clicking the **[Restart]** button to log on again.

### 3.1 Projector Web Control (continued)

#### 3.1.14 Connection Test

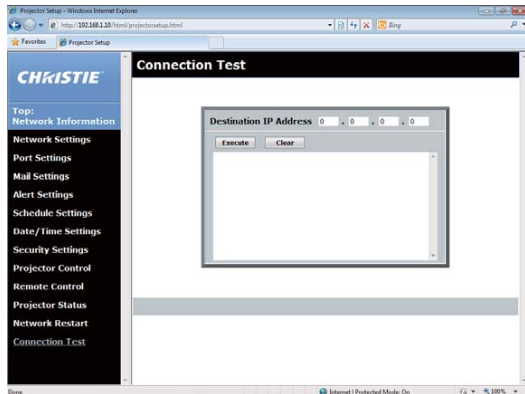

Checks if the network is connecting to DNS server or SNTP server, and so on.

Item	Description
Destination IP Address	Click the <b>[Execute]</b> button to test the connection after entering IP address to connect to.

Display example of the connection succeeded :

```

PING 192.168.1.200 (192.168.1.200): 56 data bytes
64 bytes from 192.168.1.200: seq=0 ttl=128 time=2.136 ms
64 bytes from 192.168.1.200: seq=1 ttl=128 time=0.524 ms

--- 192.168.1.200 ping statistics ---
2 packets transmitted, 2 packets received, 0% packet loss
round-trip min/avg/max = 0.524/1.330/2.136 ms
    
```

Display example of the connection failed :

```

PING 192.168.100.200 (192.168.100.200): 56 data bytes

Destination host unreachable.
    
```

- NOTE** • Confirm information of the target IP address with network administrator.
- Connection test may result in an error even if the connection is performed properly when the packets for checking the connection are discarded before arriving at the target depending on the settings of firewall or packet filtering, and so on.
  - The result of the connection test is displayed only in English.

3. Web Control

3.2 Crestron e-Control®



The Main window as shown above is displayed at first. However, if you have enabled User Password on the Tools window (72), a dialog prompting you to enter the password as shown on the right is displayed, and no operation is enabled until you have entered the password. After entering the preset password, the dialog disappears and the Main window is displayed.



User Password dialog

As shown below, you can open a window by clicking the corresponding tab at the top right of the window.

Tab	Description
<b>Logout</b>	Logs out from e-Control®. This tab appears only when User Password of the Tools window is enabled.
<b>Tools</b>	Opens Tools window. (72)
<b>Info</b>	Opens Info window. (74)
<b>Contact IT Help</b>	Opens Help Desk window. (75)

**3.2 Crestron e-Control® (continued)**

**NOTE** • Crestron e-Control® cannot be used to operate projector in the following cases:

- Network Settings - Other Setup - Crestron e-Control is Disable (📖 45)
- Network Settings - Common Setup - Crestron is OFF (📖 42)
- NETWORK menu - Third Party Control - CRESTRON is OFF (📖 34)

Set Crestron to on and enable Crestron e-Control, then close the web browser. Next, restart the web browser, followed by entering the projector's IP address.

- Only English is supported on Crestron e-Control®.
- If the connection is terminated, the Loading screen appears. Check the connection between the projector and the computer, then return or refresh the Web page.
- The control from Crestron e-Control® is only supported using wired LAN.

3. Web Control

3.2 Crestron e-Control® (continued)

3.2.1 Main window



You can operate the basic controls of the projector on this screen.

**NOTE** • If the projector is in the standby mode, only the **[Power]** button can be operated.

1. Click a button and operate as follows.

Button	Description
<b>Power</b>	Turns the power on/off.
<b>Vol - / Vol +</b>	Adjusts the volume setting.
<b>Mute</b>	Turns Mute on/off.

2. **Sources List**

You can click a button to switch the input channel. The cursor moves according to the currently selected input port.

Button	Description
<b>Computer In</b>	Selects input from <b>COMPUTER IN</b> port.
<b>HDMI 1</b>	Selects input from <b>HDMI 1</b> port.
<b>HDMI 2</b>	Selects input from <b>HDMI 2</b> port.
<b>DisplayPort</b>	Selects input from <b>DisplayPort</b> port.
<b>HDBaseT</b>	Selects input from <b>HDBaseT™</b> port.
<b>SDI (LWU701i only)</b>	Selects input from <b>SDI</b> port.
<b>Video</b>	Selects input from <b>VIDEO</b> port.
<b>LAN</b>	Selects input from <b>LAN</b> port.



**3.2 Crestron e-Control® - Main window (continued)**

3. Click a button and operate as follows. To show the hidden buttons, click the ◀ / ▶ icons at the left and right ends.

Button	Description
<b>Freeze</b>	Turns Freeze on/off.
<b>Contrast</b>	Adjusts the contrast setting.
<b>Brightness</b>	Adjusts the brightness setting.
<b>Color</b>	Adjusts the color setting.
<b>Sharpness</b>	Adjusts the sharpness setting.
<b>Magnify</b>	Controls the magnification setting using the [+] / [-] buttons. Use the [▲] [▼] [◀] [▶] buttons to move to the area you want to magnify.
<b>Auto</b>	Performs the automatic adjustment.
<b>Blank</b>	Turns the BLANK screen on/off.

4. Click the button and operate in the same way as the bundled remote control.

Button	Description
<b>Menu</b>	Assigned the same operation as <b>MENU</b> button.
<b>Enter</b>	Assigned the same operation as <b>ENTER</b> button.
<b>Reset</b>	Assigned the same operation as <b>RESET</b> button.
<b>▲</b>	Assigned the same operation as ▲ button.
<b>▼</b>	Assigned the same operation as ▼ button.
<b>◀</b>	Assigned the same operation as ◀ button.
<b>▶</b>	Assigned the same operation as ▶ button.

3. Web Control

3.2 Crestron e-Control® (continued)

3.2.2 Tools window

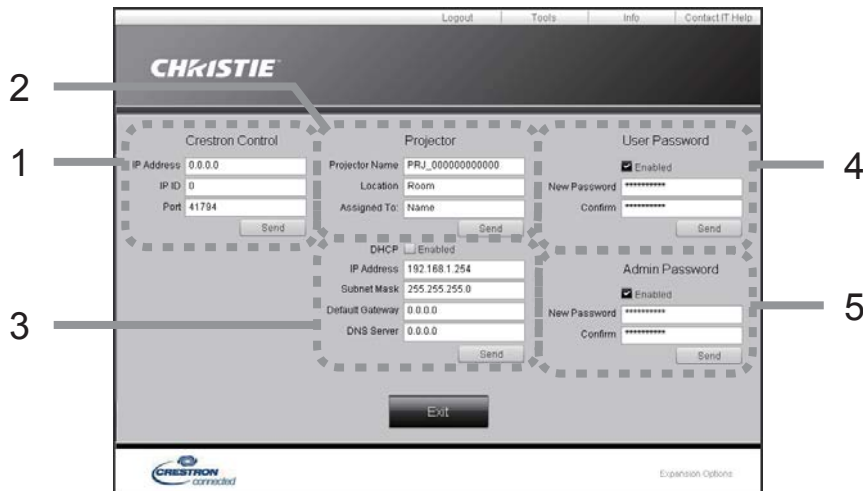

Configures the settings between the projector and Crestron® control system. Click the **[Exit]** button to return to the Main window.

**NOTE** • If two-byte characters are used, the input text or numbers cannot be set correctly.  
 • Any items on this window cannot be left blank.

1. Crestron Control

Configures the settings of Crestron® control system devices.

Item	Description
<b>IP Address</b>	Configures the IP address of the control system.
<b>IP ID</b>	Configures the IP ID of the control system.
<b>Port</b>	Specifies the port number used for communication by the control system.

To apply the settings, click the **[Send]** button.

2. Projector

Configures the network settings of the projector.

Item	Description
<b>Projector Name</b>	Configures the name of the projector. The length of the Projector Name can be up to 64 alphanumeric characters.
<b>Location</b>	Configures the location name of the projector. You can specify a Location name up to 32 alphanumeric characters.
<b>Assigned To:</b>	Configures the user name for the projector. You can specify a user name up to 32 alphanumeric characters.

The usable symbols are space and the following:

!"#\$%&'()\*+,-./:;<=>?@[\\]^\_`{|}~

To apply the settings, click the **[Send]** button.

**3.2 Crestron e-Control® - Tools window (continued)**

**3. Projector (continued)**

Configures the network settings of the projector.

Item	Description
<b>DHCP</b>	Enables DHCP.
<b>IP Address</b>	Configures the IP address when DHCP is disabled.
<b>Subnet Mask</b>	Configures the subnet mask when DHCP is disabled.
<b>Default Gateway</b>	Configures the default gateway when DHCP is disabled.
<b>DNS Server</b>	Configures the DNS server address when DHCP is disabled.

To apply the settings, click the **[Send]** button.

**4. User Password**

Configures the User Password. To prompt the entry of User Password before starting e-Control®, select the checkbox.

Item	Description
<b>New Password</b>	Configures the password. You can specify a password up to 26 alphanumeric characters. The usable symbols are space and the following: !"#\$%&'()*+,-./:;<=>@[\\]^_`{ }~
<b>Confirm</b>	Reenter the above password for verification. If the password is incorrect, an error message is displayed.

To apply the settings, click the **[Send]** button.

**5. Admin Password**

Configures the Admin Password. To prompt the entry of Admin Password before displaying the Tools window, select the checkbox.

Item	Description
<b>New Password</b>	Configures the password. You can specify a password up to 26 alphanumeric characters. The usable symbols are space and the following: !"#\$%&'()*+,-./:;<=>@[\\]^_`{ }~
<b>Confirm</b>	Reenter the above password for verification. If the password is incorrect, an error message is displayed.

To apply the settings, click the **[Send]** button.

3. Web Control

3.2 Crestron e-Control® (continued)

3.2.3 Info window



Displays the current settings and status of the projector. Click the **[Exit]** button to return to the Main window.

1. Projector Information

Item	Description
<b>Projector Name</b>	Displays the projector name settings.
<b>Location</b>	Displays the location name of the projector.
<b>MAC Address</b>	Displays the wired LAN MAC address of the projector.
<b>Resolution</b>	Displays the resolution and vertical frequency of the signal input selected on the projector.
<b>Lamp Hours</b>	Displays the usage time for the lamp.
<b>Assigned To:</b>	Displays the user name for the projector.

2. Projector Status

Item	Description
<b>Power Status</b>	Displays the power status.
<b>Input Source</b>	Displays the input signal source.
<b>Picture Mode</b>	Displays the picture mode setting.
<b>Installation</b>	Displays the installation setting.
<b>Eco Mode</b>	Displays the eco mode setting.
<b>Error Status</b>	Displays the error status.

**NOTE** • Projector Name, Location and the user name for Assigned To: may appear truncated if too long.

**3.2 Crestron e-Control® (continued)**

**3.2.4 Help Desk window**



Sends/receives messages to/from the administrator for Crestron RoomView® Express and Fusion RV®.

Button	Description
<b>Send</b>	Sends a message.
	Checks the received message.

**3. Web Control**

**3.2 Crestron e-Control® (continued)**

**3.2.5 Emergency Alert**



When the administrator for Crestron RoomView® Express and Fusion RV® sends out an alert message, it is displayed on the screen. You can reply to the alert message using a chat format. Input a message in the box below the alert message, and click the **[Send]** button.

**NOTE** • For details of Emergency Alert, refer to the manual of Crestron RoomView® Express or Fusion RV®.

- The alert message from Crestron RoomView® and Fusion RV® is displayed on the screen of the projector in the way similar to the real-time text of the Messenger function. (📖 82) If another real-time text is displayed on the screen, it is overwritten by the alert message. However, if the priority of the real-time text is set to high, the alert message does not appear on the screen. For details, refer to the manual for the application of the Messenger.

## 4. Network Presentation

### 4.1 Outline

The projector can display or play back the computer screen images and audio data that are transmitted through the network. This Network Presentation feature helps you to smoothly make your presentations and conduct conferences.



To use Network Presentation, an exclusive application, LiveViewer is required. It can be installed from the bundled application CD.

For details of Network Presentation and instructions to install the LiveViewer, refer to the manual for LiveViewer.

**NOTE** • The use of LiveViewer function depends on the model. To use the latest LiveViewer, refer to the appropriate group item in the LiveViewer User's Manual. This model is in the Group of C.

**4. Network Presentation**

**4.2 Display Mode**

LiveViewer has two display modes, Single PC mode and Multi PC mode.

**4.2.1 Single PC mode**

The Single PC mode can display images in full screen from one computer to the projector/switcher using wireless LAN or wired LAN.

■ **Presenter Mode**

In the Single PC mode, the projector can be occupied by one computer and can block access from any other computers (if Presenter Mode is set to ON in LiveViewer). While making your presentation, the screen is not unexpectedly switched to an image sent by another computer. Presenter Mode can be set to ON in the option menu in the LiveViewer.

**4.2.2 Multi PC mode**

The projector can display images of up to four computers connected at the same time.





### 4.3 Multi Projector Mode

In the Multi Projector/Multi Display mode, up to 12 projectors or switchers connected to projectors can connect with the computer using wireless or wired LAN simultaneously.

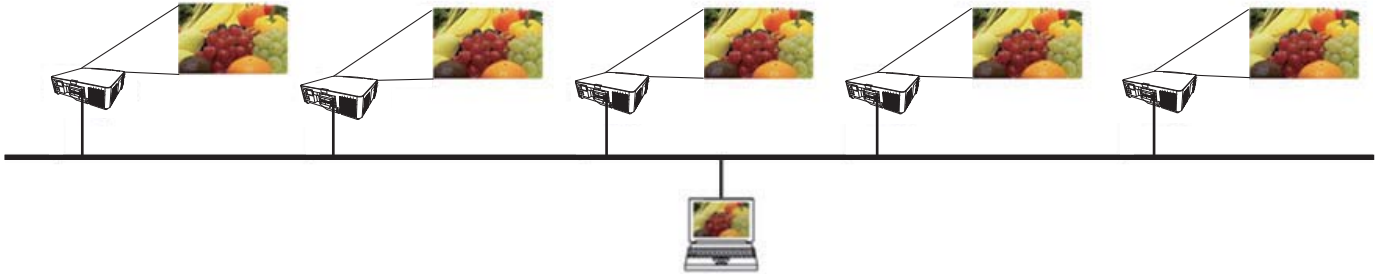

This function is for Windows users only.

### 4.4 Moderator Control Mode

One computer can be assigned as Moderator (Host) to control all other computers (Clients) or the switchers connected with the projector using wireless LAN or wired LAN. Because Clients cannot control the LiveViewer and the projector, the Host can proceed with the program as arranged smoothly and safely.

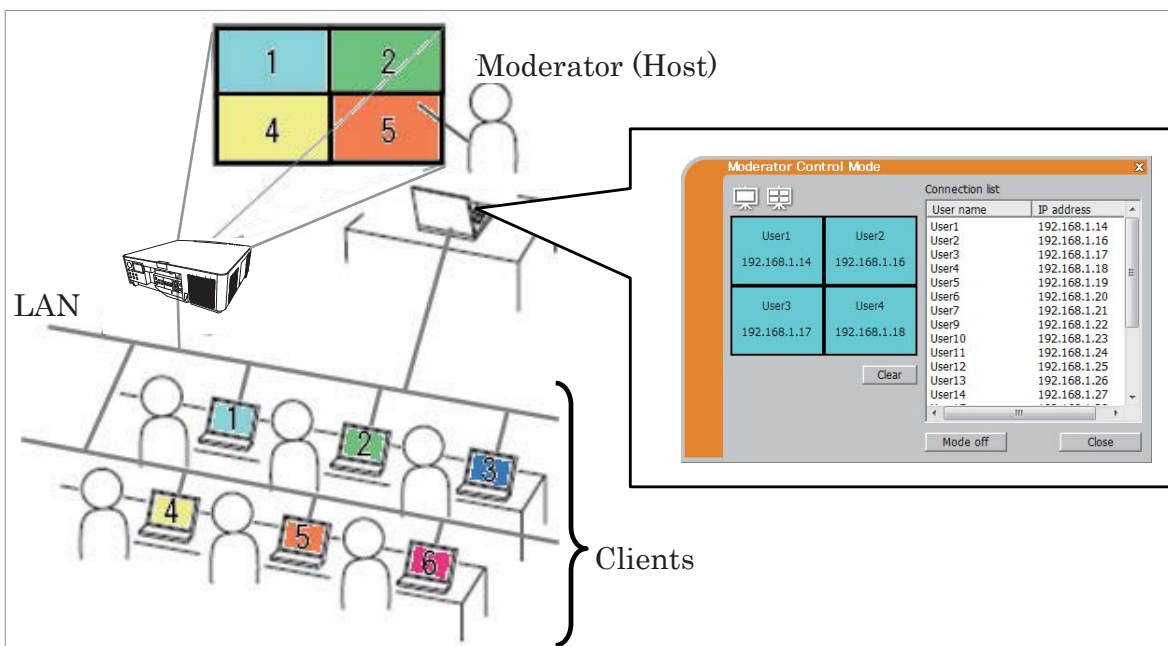

This function is for Windows users only.

## 4. Network Presentation

### 4.5 Port Number

The following port numbers used for LiveViewer:

Port No.	Protocol
5500	TCP
5900	TCP
9720	TCP

**NOTE** • When an other application uses the ports above, LiveViewer and Christie QuickConnect may not work.

## 5. My Image Function

The projector can display still images transferred using the network. You can allocate up to four image files.

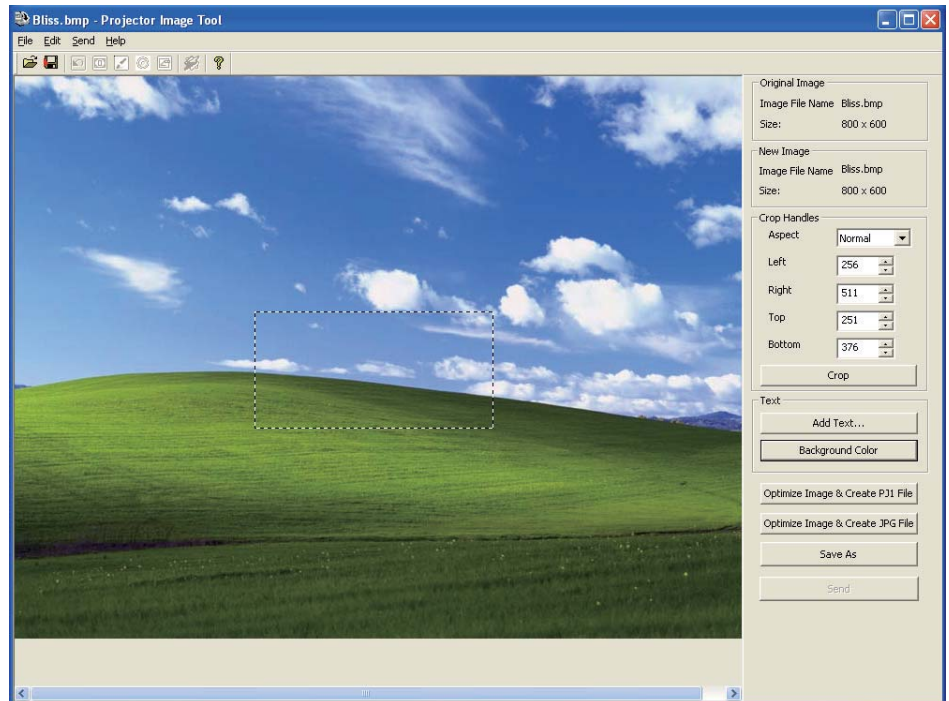

MY IMAGE transmission requires an exclusive application for your computer. Use the application to transfer the image data.

For information on the necessary settings and operations for the computer and projector, refer to the manual for the application. To display the transferred image, select the MY IMAGE item in the NETWORK menu. For more information, see the description of the MY IMAGE item of the NETWORK menu.

- NOTE** • Using MY BUTTON registered as MY IMAGE can display transferred image. (📖OPTION menu in the Operating Guide)
- The image file also can be displayed by using schedule function from the web browser.(📖94)
  - If data is transferred using wireless and wired LAN at the same time, the projector may not process the data correctly.

6. Messenger Function

6. Messenger Function

6.1 Outline

The projector can display text data transferred using the network on the screen and play back audio data inside the projector.

The text data can be displayed on the screen in two ways. One is to display the text transferred from the computer on real time, and the other is to choose the text data stored in the projector and display it.

Up to 12 text data can be stored.

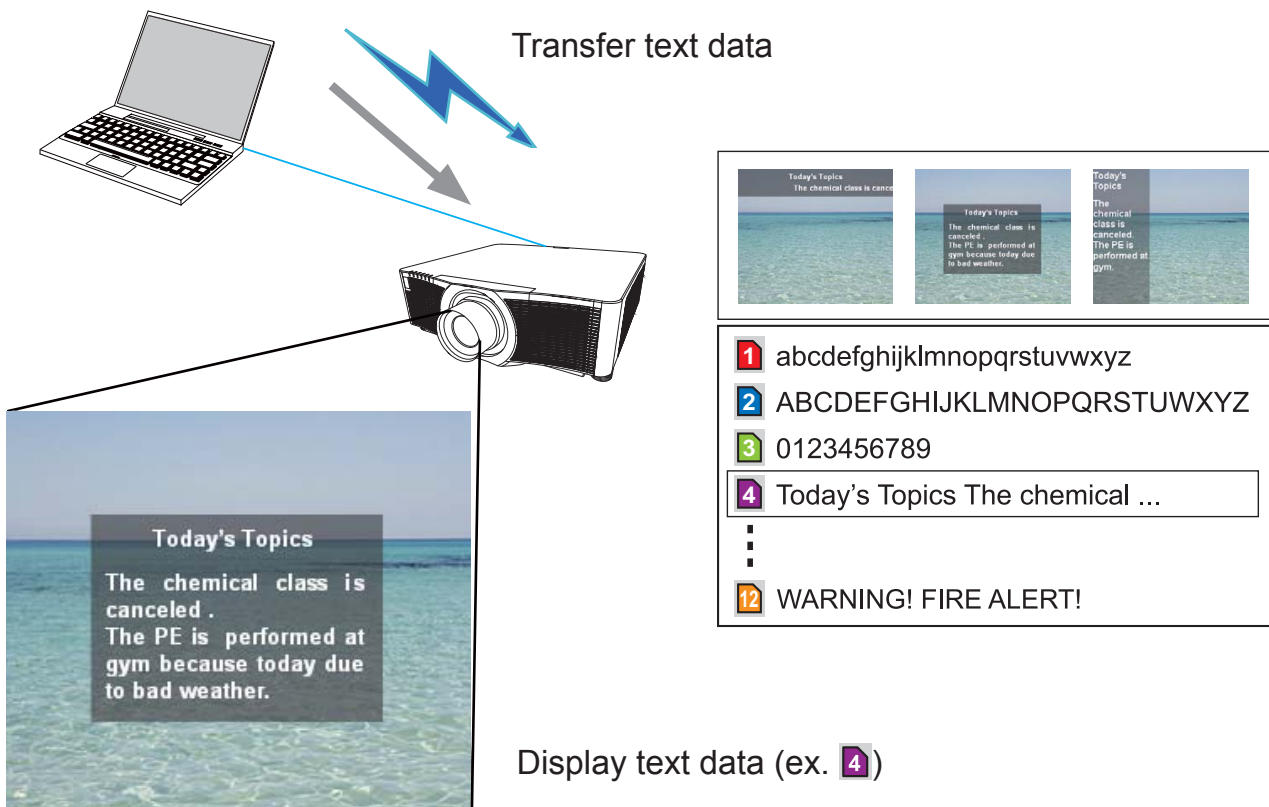

Display text data (ex. 4)

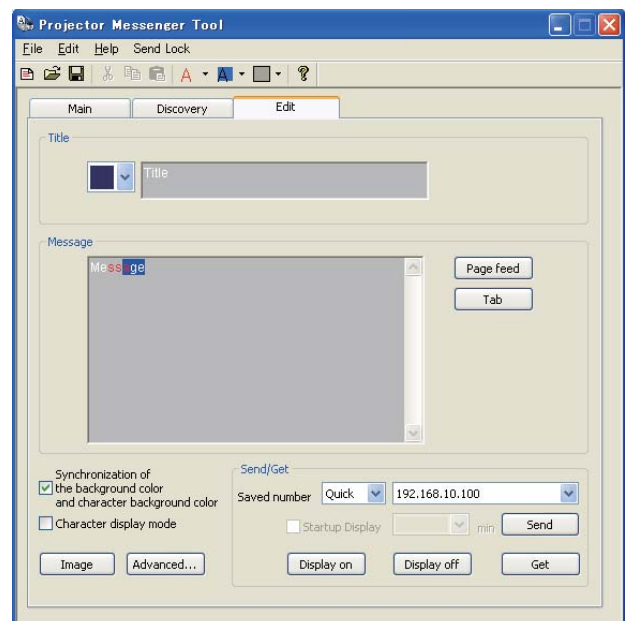

Messenger function requires an exclusive application for your computer. To edit, transfer and display the text data, use the application.

For information on the necessary settings and operations for the computer and projector, refer to the manual for the application.

**6.2 Supported Languages**

The following languages can be displayed by the Messenger function.

English, French, German, Spanish, Italian, Norwegian, Dutch, Portuguese, Swedish, Finnish, Polish, Russian, Turkish, Japanese, Simplified Chinese, Traditional Chinese, Korean

**6.3 Display Style**

There are four types of message display style. The following is the description of each type.

1) Scroll  
The message scrolls to the left in the message display area.



2) Box (Scroll up)  
The message scrolls upwards in the square message display area.

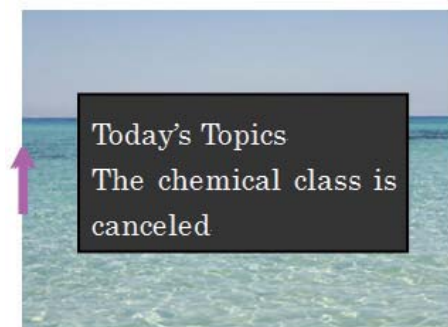

6. Messenger Function

3) Pop on

The message is displayed in full view in the square message display area.

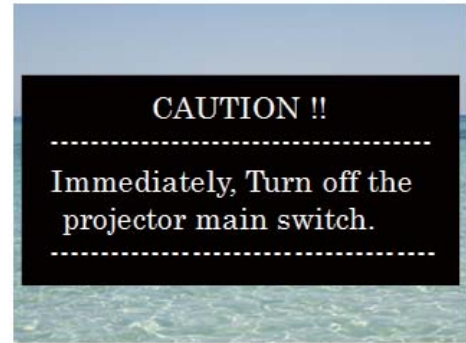

4) Picture Side

The message is displayed in the message display area on the right or left.

This style is available only for WXGA and WUXGA model projector.



- NOTE** • Using **MY BUTTON** registered as MESSENGER can turn the displaying messenger text on/off. (📖OPTION menu in the Operating Guide)
- The text file also can be displayed by using schedule function using the web browser. (📖94)
  - If data is transferred using wireless and wired LAN at the same time, the projector may not process the data correctly.

## 7. Network Bridge Function

This projector is equipped with the NETWORK BRIDGE function to perform mutual conversion of a network protocol and a serial interface.

By making use of the NETWORK BRIDGE function, a computer connected to the projector using wireless or wired LAN is able to control an external device using RS-232C communication using the projector as a network terminal.

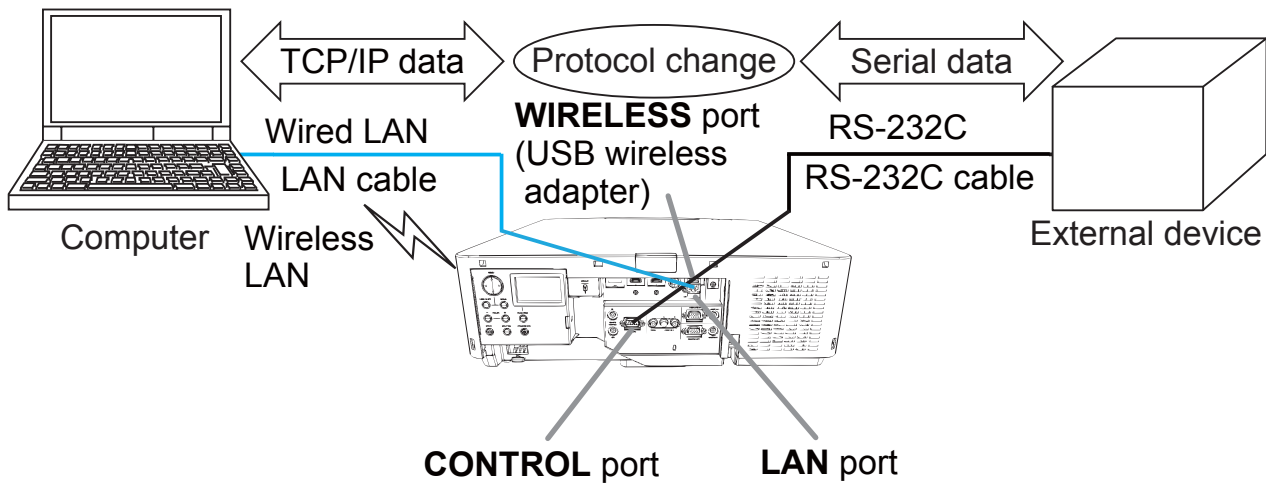

### 7.1 Connecting devices

- 1) Connect the projector's **LAN** port to the computer's LAN port with a LAN cable, or insert the USB wireless adapter into the **WIRELESS** port.
- 2) Connect the projector's **CONTROL** port and the device's RS-232C port with an RS-232C cable, for RS-232C communication.

**NOTE** • Before connecting the devices, read the manuals for the devices to ensure the connection. For RS-232C connection, check the specifications of each port and use the suitable cable. (📖 Connection to the ports in the Operating Guide - Technical)



7. Network Bridge Function

## 7.2 Communication setup

To configure the setup of the communication using NETWORK BRIDGE for the projector, use items in the COMMUNICATION menu. Open the menu of the projector and select the OPTION - SERVICE - COMMUNICATION menu. (📖OPTION menu > SERVICE > COMMUNICATION in the Operating Guide)

- 1) In the COMMUNICATION TYPE menu, select NETWORK BRIDGE (WIRELESS or WIRED depending on the type of connection you use) for the **CONTROL** port.
- 2) Using the SERIAL SETTINGS menu, select the proper baud rate and parity for the **CONTROL** port, according to the specification of the RS-232C port of the connected device.

Item	Condition
BAUD RATE	4800bps/9600bps/19200bps/38400bps
PARITY	NONE/ODD/EVEN
Data length	8 bit (fixed)
Start bit	1 bit (fixed)
Stop bit	1 bit (fixed)

- 3) Using the TRANSMISSION METHOD menu, set up the proper method for the **CONTROL** port according to your use.

**NOTE** • The OFF is selected for the COMMUNICATION TYPE as the default setting.

- Using the COMMUNICATION menu, set up the communication. An unsuitable setup could cause malfunction of communication.
- When either one of the NETWORK BRIDGE settings is selected in the COMMUNICATION TYPE menu, RS-232C commands cannot be received from the **CONTROL** port.

## 7.3 Communication port

For the NETWORK BRIDGE function, send the data from the computer to the projector with using the Network Bridge Port configured in the Port Settings of web browser. (📖46)

**NOTE** • Except for 41794, 9715, 9716, 9719, 9720, 5900, 5500, 4352 between 1024 and 65535 can be set up as the Network Bridge Port number. It is set to 9717 as the default setting.



## 7.4 Transmission method

The transmission method can be selected from the menus, only when the NETWORK BRIDGE is selected for the COMMUNICATION TYPE.

( OPTION menu > SERVICE > COMMUNICATION in the Operating Guide)

HALF-DUPLEX ↔ FULL-DUPLEX

### 7.4.1 HALF-DUPLEX

This method lets the projector make two way communication, but only one direction, either transmitting or receiving data, is allowed at a time.

The method does not allow the projector to receive the data from the computer while waiting for response data from an external device. After the projector receives the response data from an external device or the response limit time is past, the projector can receive the data from the computer.

That means that the projector controls transmitting and receiving the data to synchronize the communication.

To use the HALF-DUPLEX method, set up the RESPONSE LIMIT TIME following the instructions below.

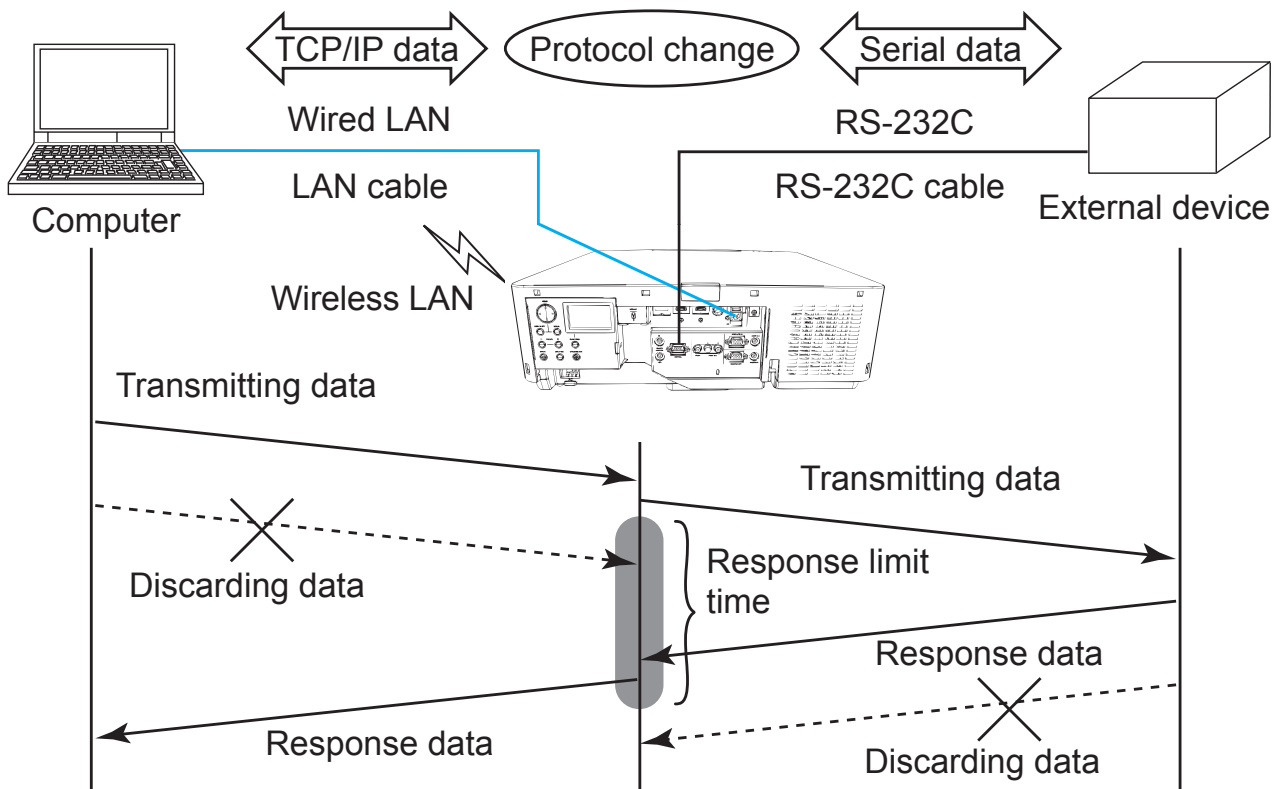

Using the RESPONSE LIMIT TIME menu, set the waiting time for response data from an external device. ( OPTION menu > SERVICE > COMMUNICATION in the Operating Guide)

OFF ↔ 1s ↔ 2s ↔ 3s (↔ OFF)

## 7. Network Bridge Function

### 7.4 Transmission method (continued)

**NOTE** • With using the HALF-DUPLEX method, the projector can send out 254 byte data at the maximum at a time.

- If it is not required to monitor the response data from an external device and the RESPONSE LIMIT TIME is set to OFF, the projector can receive the data from the computer and send it out to an external device continuously. The OFF is selected as the default setting.

#### 7.4.2 FULL-DUPLEX

This method lets the projector make two way communication, transmitting and receiving data at the same time, without monitoring response data from an external device.

With using this method, the computer and an external device send the data out of synchronization. If synchronization is required, set the computer to synchronize.

**NOTE** • When the computer controls the synchronization of receptions and transmissions, the external device may not be controlled properly depending on the status of data processing of the projector.

**8. Other Functions**

**8.1 Email Alerts**

The projector can automatically send an alert message to the specified email addresses when the projector detects a certain condition that is requiring maintenance or detected an error.

- NOTE** • Up to five email addresses can be specified.
- The projector may be not able to send email if the projector suddenly loses power.
  - Emails may not be sent correctly depending on the mail environment you are using.

Alerts available to email alerts are as follows.

Item	Description
<b>Cover Error</b>	The lamp cover has not been properly fixed.
<b>Fan Error</b>	The cooling fan is not operating.
<b>Lamp Error</b>	The lamp does not light, and the interior portion may have become heated.
<b>Temp Error</b>	The interior portion may have become heated.
<b>Air Flow Error</b>	The internal temperature is rising.
<b>Cold Error</b>	The interior portion may have become overcooled.
<b>Filter Error</b>	Filter time over.
<b>Shutter Error</b>	The shutter does not work correctly.
<b>Lens Shift Error</b>	The Lens shift does not work correctly.
<b>AC Blackout Error</b>	Power supply was interrupted momentarily.
<b>Other Error</b>	Errors other than the above. If this error is displayed, contact your dealer.
<b>Schedule Execution Error</b>	Failed to execute scheduled events.
<b>Lamp Time Alarm</b>	Lamp Time has exceeded the specified alarm limit.
<b>Filter Time Alarm</b>	Filter Time has exceeded the specified alarm limit.
<b>Filter Status Notification</b>	The status to clean the air filter is changed.
<b>Transition Detector Alarm</b>	Transition Detector Alarm. (  <b>SECURITY menu</b> in the <b>Operating Guide</b> )

(continued on next page)

**NOTE** • The timing of receiving Filter Error email is depending on the FILTER MESSAGE setting in the LAMP & FILTER item of the SETUP menu which determines the period until the filter message is displayed on the projector screen. An email is sent when the usage time of the filter exceeds the set time limit. No notification email is sent if the FILTER MESSAGE is set to OFF.

(📖SETUP menu in the Operating Guide)

- **Lamp Time Alarm** is a threshold for email notification of the lamp time. When the set time exceeds the limit configured in the Projector Web Control, an email is sent.
- **Filter Time Alarm** is a threshold for email notification of the filter time. When the set time exceeds the limit configured in the Projector Web Control, an email is sent.
- **Filter Status Notification** can be enabled for both or either one of **Status 1** and **2**. These notifications are equivalent to changing the **FILTER** indicator on the projector. (**Status 1**: off to orange, **Status 2**: orange to red) Refer to the **Operating Guide** for details of the **FILTER** indicator.

To use the projector’s email alert function, configure the following items through a web browser.

**Mail Settings (📖 48)**

- 1) Select **[Mail Settings]** on main menu in Projector Web Control.
- 2) Configure each item in Mail Settings page. Refer to item 3.1.5 Mail Settings (📖 48) for further information.
- 3) Click the **[Apply]** button to save the settings.
- 4) Click the **[Send Test Mail]** button to confirm that the email settings are correct. The following mail is delivered to the specified addresses.

Subject line: Test Mail <Projector name>

Text : Send Test Mail

Date	<Testing date>
Time	<Testing time>
IP Address	<Projector IP address>
MAC Address	<Projector MAC address>

**Alert Settings (📖 50)**

- 1) Select **[Alert Settings]** on main menu in Projector Web Control.
- 2) Select and configure each alert item. Refer to item 3.1.6 Alert Settings (📖 50) for further information.
- 3) Click the **[Apply]** button to save the settings.

Failure/Warning emails are formatted as follows:

Subject line: <Mail subject> <Projector name>

Text : <Message>

Date	<Failure/Warning date>
Time	<Failure/Warning time>
IP Address	<Projector IP address>
MAC Address	<Projector MAC address>

## 8.2 Projector Management using SNMP

The SNMP (Simple Network Management Protocol) manages the projector information, such as a failure or warning status, from the computer on the network.

**NOTE** • It is recommended that SNMP functions are executed by a network administrator.

- SNMP management software must be installed on the computer to monitor the projector using SNMP.

### Standard MIB (MIB-2)

Refer to the following items defined in system group of Standard MIB (MIB-2).

Item	Description
sysName	Projector name is set.
sysLocation	The information on where it is located. It has character string set in sysLocation (SNMP) in Projector Web Control - [Network Settings] - [Common Setup].
sysContact	The information on the administrator's contact information. It has character string set in sysContact (SNMP) in Projector Web Control - [Network Settings] - [Common Setup].

### Enhanced MIB

Access configuration information using the Enhanced MIB for projectors. Enhanced MIB for projectors can be downloaded from [Port Settings] page in Projector Web Control.

### Trap

When an error or warning occurs in the projector, a notification can be sent to the specified address.

In addition to email alert shown in 8.1 Email Alerts (📖 89), the following notification can be sent.

Item	Description
Cold Start	When the projector is supplied with the power, it works as below. <ul style="list-style-type: none"> <li>• If the STANDBY MODE is set to the NORMAL: the projector's power status changes from OFF to Standby state.</li> <li>• If the STANDBY MODE is set to the POWER SAVE: the projector's power status changes from Standby state to ON (lamp is turned on).</li> </ul> (📖 SETUP menu in the Operating Guide).
Authentication Failure	The SNMP access is detected from the invalid SNMP community.

Setup the following functions through WEB browser, to manage the projector by SNMP.

**Port Settings** (📖 46)

- 1) Select **[Port Settings]** on main menu in Projector Web Control.
- 2) Click the **[Download MIB file]** to download a MIB file.
- 3) Click the **[Enable]** checkbox to open the SNMP Port. Set the address to send the SNMP trap to when a Failure/Warning occurs.

**Security Settings** (📖 58)

- 1) Select **[Security Settings]** on main menu in Projector Web Control.
- 2) Click the **[SNMP]** and set the community name on the displayed screen.

**Alert Settings** (📖 50)

Configure the settings for Trap transmission of Failures/Warnings.

- 1) Select **[Alert Settings]** on main menu in Projector Web Control.
- 2) Select the Failure/Warning item to be configured.
- 3) Click the **[Enable]** checkbox to send out the SNMP trap for Failures/Warnings. Clear the **[Enable]** checkbox when SNMP trap transmission is not required.
- 4) Click the **[Apply]** button to save the settings.

**NOTE** • Register the downloaded MIB file to SNMP manager program to be used.  
 • Be sure to execute Network Restart when the settings of **[Port Settings]** or **[Security Settings]** is changed.

### 8.3 Event Scheduling

The scheduling function sets up scheduled events including power on / power off. It enables the projector to be self-management.

Note the following before setting the schedule.

- NOTE** • Schedule can also be set in OPTION - SCHEDULE menu of the projector. (📖 Refer to Operating Guide – OPTION).
- A maximum of 16 programs of schedule can be set. A maximum of 20 events can be registered in one program.
  - No events are registered in program 1 – 16 with factory default settings. The program is required to be set in advance when using the schedule function for the first time.
  - The priority for scheduled events is as follows 1) specific date 2) weekly
  - Up to 10 specific dates are available for scheduled events. Priority is given to those with the lower numbers when more than one event has been scheduled for the same date and time (for example, 'Specific date No. 1' has priority over 'Specific date No. 2' and so on.
  - The power on event has the lowest priority among all the events set at the same time.
  - Set the date and time before enabling scheduled events. (📖 56)
  - After the projector is moved, check the date and time set for the projector before configuring the schedules.
  - The internal clock's time may not remain accurate. Using SNTP is recommended to maintain accurate time.
  - Certain error states in the projector (such as temperature error, lamp error) prevent the projector from appropriate execution of scheduled functions/events.
  - Events **My Image** and **Messenger** are not executed appropriately and result in schedule execution error status when the lamp does not light and/or data to be displayed are not stored in the projector at the time when scheduled event is executed.
  - Events **Input Source** and **My Image** are not executed if the security function is enabled and the projector is locked due to the function.



The following procedure sets the schedule in Projector Web Control.

Setting the program is necessary to use the schedule function. Various events such as power on/off or switching input source, and the time to execute the events must be registered in the program. No events are registered in program 1 – 16 with factory default settings. Set the program following the steps below. In the case that the program has already been set, skip to step 6).

1) Select **[Schedule Settings]** on main menu in Projector Web Control.

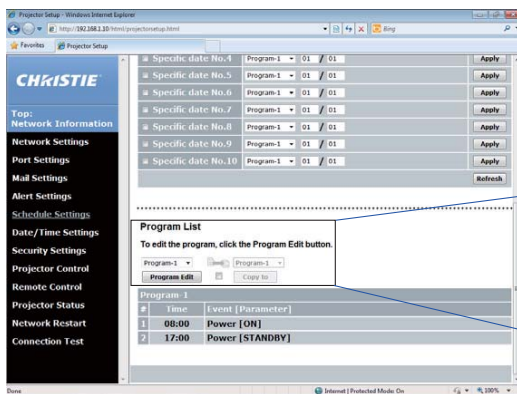

**Program List**

To edit the program, click the **Program Edit** button.



2) Select the program number in list under Program List and click the **[Program Edit]** button to display the following program edit display. The display for editing Program-1 is shown below.

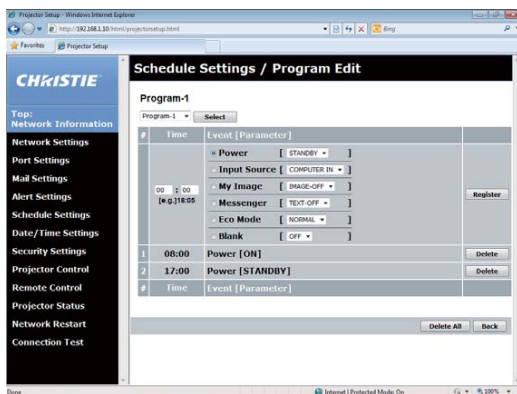

3) After setting the time, events and parameters, click the **[Register]** to add the new event.

Click the **[Delete]** button to delete an event.

Click the **[Delete All]** button to delete all the events in the currently selected program.

8. Other Functions

4) To edit the program with other number continuously, select the program you want to edit in list and click the **[Select]** button to display the display for editing the selected program.

5) Click the **[Back]** button to return to schedule management screen after finishing the program setting.

The procedure to assign the program set in the step 1) ~ 5) to the schedule is described in the following.

6) Click the checkbox of the schedule to be executed (for example, click the checkbox of Monday checkbox, when it is to be executed on Mondays) in the schedule management screen.

7) Select the program to be executed in list. Confirm the event information registered in each program in the program list on the bottom of the screen. When setting the Specific date No.1 ~ 10, enter the date (month/day).

8) Click the **[Apply]** button to save the schedule settings in the projector. Repeat step 6) ~ 8) similarly to set the schedule you want to execute.

9) The schedule settings are now complete. Confirm the time stored in the projector is correctly set.

■How to copy the program

When you copy the currently selected program to other program, click the checkbox under  icon. Click the **[Copy to]** button after selecting the program to which you want to copy in list.

The same program as the currently selected one cannot be specified as the program to which you want to copy.

**Program List**

To edit the program, click the **Program Edit** button.

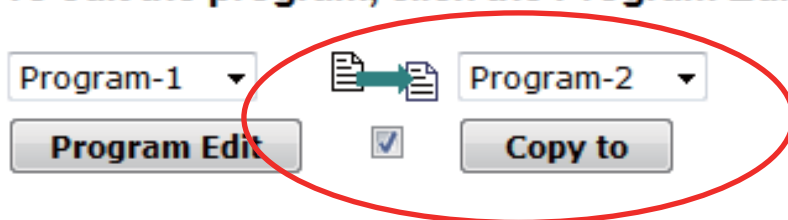

## 8.4 Command Control via the Network

Configure and control the projector using the network using RS-232C commands.

### Communication Port

The following two ports are assigned for the command control.

TCP #23 (Network Control Port1 (Port: 23))

TCP #9715 (Network Control Port2 (Port: 9715))

**NOTE** • Command control is available using only the specified port above.

### Command Control Settings (📖 46)

Configure the following items from a web browser when command control is used.

**Example:** If the IP address of the projector is set to **192.168.1.10**:

- 1) Enter “**http://192.168.1.10/**” into the address bar of the web browser, and select Projector Web Control from the selection window.
- 2) Enter your user name and password, and then click the **[OK]**.
- 3) Click the **[Port Settings]** on the main menu.

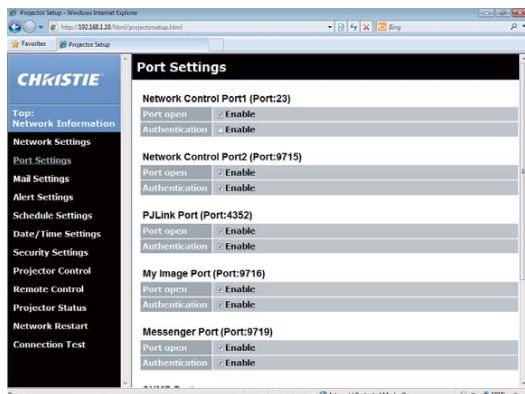

- 4) Click the **[Enable]** checkbox to open **Network Control Port1 (Port: 23)** to use TCP #23. Click the **[Enable]** checkbox for the **[Authentication]** setting when authentication is required, otherwise clear the checkbox.
- 5) Click the **[Enable]** checkbox to open **Network Control Port2 (Port: 9715)** to use TCP #9715. Click the **[Enable]** checkbox for the **[Authentication]** setting when authentication is required, otherwise clear the checkbox.
- 6) Click the **[Apply]** button to save the settings.

8. Other Functions

8.4 Command Control via the Network (continued)

When the authentication setting is enabled, the following settings are required. (📖 58)

- 7) Click the **[Security Settings]** on the main menu.
- 8) Click the **[Network Control]** and enter the required authentication password.
  - \* See NOTE.
- 9) Click the **[Apply]** button to save the settings.

**NOTE** • The Authentication Password is the same for **Network Control Port1 (Port: 23)**, **Network Control Port2 (Port: 9715)**, **PJLink™ Port (Port: 4352)**, **My Image Port (Port: 9716)** and **Messenger Port (Port: 9719)**.

- The new configuration settings are activated after restarting the network connection. When the configuration settings are changed, you must restart the network connection. You can restart the network connection from Network Restart on the main menu. (📖 66)

**8.4 Command Control via the Network (continued)**

**Command Format**

Command formats differ among the different communication ports.

● TCP #23

You can use the RS-232C commands without any changes. The reply data format is the same as the RS-232C commands. ([📖RS-232C Communication in the Operating Guide - Technical](#))

However, the following reply is sent back in the event of authentication failure when authentication is enabled.

<Reply in the event of an authentication error>

Reply	Error code	
0x1F	0x04	0x00

● TCP #9715

**Send Data format**

The following formatting is added to the header (0 x 02), Data length (0 x 0D), Checksum (1 byte) and Connection ID (1 byte) of the RS-232C commands.

Header	Data length	RS-232Ccommand	Check Sum	Connection ID
0x02	0x0D	13 bytes	1 byte	1 byte

- Header → 0x02, Fixed
- Data length → RS-232C commands byte length (0x0D, Fixed)
- RS-232C command → RS-232C commands that start with 0xBE 0xEF (13 bytes)
- Check Sum → This is the value to make zero on the addition of the lower 8 bits from the header to the checksum.
- Connection ID → Random value from 0 to 255 (this value is attached to the reply data.)

**8. Other Functions**

**8.4 Command Control via the Network (continued)**

**Reply Data format**

The connection ID (the data is same as the connection ID data on the sending data format) is attached to the RS-232C commands reply data.

<ACK reply>

Reply	Connection ID
0x06	1 byte

<NAK reply>

Reply	Connection ID
0x15	1 byte

<Error reply>

Reply	Error code	Connection ID
0x1C	2 bytes	1 byte

<Data reply>

Reply	Data	Connection ID
0x1D	2 bytes	1 byte

<Projector busy reply>

Reply	Status code	Connection ID
0x1F	2 bytes	1 byte

<Authentication error reply>

Reply	Authentication Error code		Connection ID
0x1F	0x04	0x00	1 byte

### 8.4 Command Control via the Network (continued)

#### Automatic Connection Break

The TCP connection is automatically disconnected after there is no communication for 30 seconds after being established.

#### Authentication

The projector does not accept commands without authentication success when authentication is enabled. The projector uses a challenge response type authentication with an MD5 (Message Digest 5) algorithm.

When the projector uses a LAN, a random 8 bytes is returned if authentication is enabled. Bind this received 8 bytes and the Authentication Password and convert this data using the MD5 algorithm and add this in front of the commands to send.

Following is a sample if the Authentication Password is set to password and the random 8 bytes are a572f60c.

- 1) Connect the projector.
- 2) Receive the random 8 bytes a572f60c from the projector.
- 3) Bind the random 8 bytes a572f60c and the Authentication Password “password” and it becomes a572f60cpassword.
- 4) Convert this bind a572f60cpassword using the MD5 algorithm.  
It is e3d97429adffa11bce1f7275813d4bde.
- 5) Add this e3d97429adffa11bce1f7275813d4bde in front of the commands and send the data.  
Send e3d97429adffa11bce1f7275813d4bde + command.
- 6) When the sending data is correct, the command is performed and the reply data is returned. Otherwise, an authentication error is returned.

**NOTE** • For the transmission of the second or subsequent commands, the authentication data can be omitted when the same connection.

## **8.5 Crestron Connected™**

Crestron Connected™ is a multi-user resource management program provided by Crestron Electronics, Inc. It is an application for managing and controlling the projector and other AV devices collectively.

For details of Crestron Connected™, refer to the Crestron® website.

URL: <http://www.crestron.com>

The following communication interfaces can be used to manage the entire facility.

- 1) Crestron Fusion RV® / Crestron RoomView® Express / Crestron RoomView® Server Edition  
Fusion RV®, RoomView® Express and RoomView® Server Edition are software provided by Crestron Electronics, Inc. They are used for managing all the AV devices, and are also able to communicate with the help desk as well as send out alert messages.

For details of the software, refer to the following website.

URL: <http://www.crestron.com/getroomview>

- 2) Crestron e-Control®

Crestron e-Control® is a system controller that can be operated using a web browser. (📖 68)



**9. Troubleshooting**

Issue: Cannot communicate with the projector. (Wired network)

Item to be checked	Solutions
Is the projector turned on?	Turn on the projector.
Is the network device such as a router, and so on turned on?	Turn on the network device.
Is STANDBY MODE set to POWER SAVE?	The network function is not available when STANDBY MODE is set to POWER SAVE. To use the network function in the standby mode, set to NORMAL.
Is LAN cable connected?	Connect the LAN cable.
Is MAC address displayed correctly in the NETWORK INFORMATION – WIRED menu?	Contact your dealer when MAC address on the label put on the projector does not match MAC address displayed in the NETWORK INFORMATION – WIRED menu.
Are the network settings such as IP address set correctly?	Check the network settings in the NETWORK INFORMATION – WIRED menu. Consult with your network administrator for details.
Is firewall or packet filtering set in a router, and so on?	Consult with your network administrator.
Is the same network address set for wireless LAN and wired LAN of the projector?	The same network address cannot be used for wireless LAN and wired LAN. Set different network address for wireless LAN and wired LAN.
Is the wired network adapter of the computer enabled?	Refer to the user’s manual for the computer and enable the wired network adapter.

**9. Troubleshooting**

Issue: Cannot communicate with the projector. (Wireless network)

Item to be checked	Solutions
Is the projector turned on?	Turn on the projector.
Is the network device such as an access point, and so on turned on?	Turn on the network device.
Is STANDBY MODE set to POWER SAVE?	The network function is not available when STANDBY MODE is set to POWER SAVE. To use the network function in the standby mode, set to NORMAL.
Are the network settings such as IP address set correctly?	Check the network settings in the NETWORK INFORMATION – WIRELESS menu. Consult with your network administrator for details.
Is the USB wireless adapter (optional parts: USB-WL-11N-NS) inserted into <b>WIRELESS</b> port of the projector?	Insert the USB wireless adapter.
Is an optional USB wireless adapter used?	The USB wireless adapter available to this projector is optional USB-WL-11N-NS only.
Is MAC address displayed correctly in the NETWORK INFORMATION – WIRELESS menu?	When MAC address displayed in NETWORK INFORMATION – WIRELESS menu does not match MAC address engraved on the USB wireless adapter, pull out and insert the USB wireless adapter again. If the problem persists, the USB wireless adapter may be broken. Contact your dealer.
Is LED of the USB wireless adapter blinking?	When LED of the USB wireless adapter does not blink in over one minute after inserting, remove and insert the USB wireless adapter again. If the problem persists, the USB wireless adapter may be broken. Contact your dealer.

Issue: Cannot communicate with the projector. (Wireless network) (continued)

Item to be checked	Solutions
Is firewall or packet filtering set in an access point, and so on?	Consult with your network administrator.
Is the wireless network to connect encrypted?	Set the encryption settings of the projector again and reconnect.
Is an encryption method which is not supported by the projector used?	<p>The followings are encryption methods supported by the projector:</p> <ul style="list-style-type: none"> <li>· WPA2-PSK(AES)</li> <li>· WPA2-PSK(TKIP)</li> <li>· WPA-PSK(AES)</li> <li>· WPA-PSK(TKIP)</li> <li>· WEP128bit (Available only in INFRASTRUCTURE mode)</li> <li>· WEP64bit (Available only in INFRASTRUCTURE mode)</li> </ul> <p>This projector cannot be connected to the wireless network using the encryption methods other than the above.</p>
Is signal strength of wireless network displayed in the SSID SCAN LIST menu weak?	<ul style="list-style-type: none"> <li>· Put the projector close to the wireless device.</li> <li>· When the projector is near the steel door, the radio wave may not reach to the wireless device. In that case, keep the projector away from the door.</li> <li>· Consult with your network administrator because there may be an interfering wireless device.</li> </ul>
Is 5GHz radio wave used?	The USB wireless adapter (USB-WL-11N-NS) does not support 5GHz, but only 2.4GHz.
Is the same network address set for wireless LAN and wired LAN of the projector?	The same network address cannot be used for wireless LAN and wired LAN. Set a different network address for wireless LAN and wired LAN.
Is the wireless network adapter of the computer enabled?	Refer to the user's manual for the computer and enable the wireless network adapter.

**9. Troubleshooting**

Issue: Cannot communicate with the projector. (Wireless network) (continued)

Item to be checked	Solutions
Are over 11 devices connected to the projector?	<ul style="list-style-type: none"> <li>• Confirm the number of the devices connected to the projector. Up to 11 devices can be connected to the projector in Simple Access Point mode.</li> <li>• When the projector is connected to the maximum numbers of devices, connect after disconnecting the device currently connected.</li> </ul>
Is the DHCP setting of the computer disabled?	Enable the DHCP setting of the computer. Refer to the user's manual of the computer or wireless LAN device for the setting procedure of the network and wireless connection of the computer.
Is it used in SIMPLE ACCESS POINT mode?	Change the channel setting.
Dose the IP address overlap with that of the other devices ?	When the IP address overlaps, turn off your WiFi device and turn on again.

Issue: Cannot use wireless LAN and wired LAN at the same time.

Item to be checked	Solutions
Is the same network address set for wireless LAN and wired LAN of the projector?	The same network address cannot be used for wireless LAN and wired LAN. Set a different network address for wireless LAN and wired LAN.
Are you trying to access to different network using a router?	Either wired LAN or wireless LAN can access to a different network. Set the default gateway of either wired LAN or wireless LAN to 0.0.0.0.

Issue: Web(Projector Web Control) is not displayed correctly.

Item to be checked	Solutions
Is the correct URL entered in Web browser?	Enter the IP address of the projector in Web browser.
Is JavaScript enabled?	Enable JavaScript. How to set is different depending on the Web browser. Refer to Help of Web browser, and so on for details.
Is recommended Web browser used?	Recommended Web browsers are Internet Explorer 8/9/10/11. Projector Web Control may not displayed correctly except in recommended browser.
Is the cache of the screen displayed earlier remaining?	Clear the cache. How to set is different depending on the Web browser. Refer to Help of Web browser, and so on for details.

**9. Troubleshooting**

Issue: Crestron e-Control® is not displayed.

Item to be checked	Solutions
Has Adobe® Flash® Player been installed?	Adobe® Flash® Player is required to display Crestron e-Control®. Install Adobe® Flash® Player.
Is Web browser that does not support Adobe® Flash® Player used?	Use a Web browser that supports Adobe® Flash® Player.
Are Crestron e-Control® settings on Network Settings – Other Setup screen of the Projector Web Control disabled?	Enable Crestron e-Control® settings on Network Settings – Other Setup screen of the Projector Web Control.
Is Crestron in Projector Web Control - Network Settings - Common Setup set to OFF?	Set Crestron in Projector Web Control - Network Settings - Common Setup to ON.

Issue: Cannot send an email correctly.

Item to be checked	Solutions
Is a test email sent correctly?	Check if a test email is sent correctly by pressing the [Send Test Mail] button on the Mail Settings screen of the Projector Web Control.
Are email settings correct?	Check the settings on the Mail Settings screen of the Projector Web Control.
Are the settings of Sender email Address correct?	Set valid email address.
Is only email regarding the specific Error/Warning not sent correctly?	Check if the specific Error/Warning is set to be sent on the Mail Settings screen of the Projector Web Control.

Issue: An email does not reach only to the specific address.

Item to be checked	Solutions
Is email address set correctly?	Check the settings on the Mail Settings screen of the Projector Web Control.
Is filtering or forwarding set for the email address in the mail server?	Consult with your network administrator.

Issue: The schedule is not executed correctly.

Item to be checked	Solutions
Is the projector turned on?	Turn on the projector.
Is STANDBY MODE set to POWER SAVE?	The schedule function is not available when STANDBY MODE is set to POWER SAVE. To use the schedule function in the standby mode, set to NORMAL.
Is the time set correctly?	Check the settings of Date and Time.
Is the image data to be displayed in the schedule function registered? (When the event of My Image is set.)	Register the image data to be displayed with the projector by using exclusive application software.
Is the message data to be displayed in the schedule function registered? (When the event of Messenger is set.)	Register the message data to be displayed with the projector by using exclusive application software.
Is the lamp of the projector lighting?	The events of My Image, Messenger and Blank are not executed when the lamp is not lighting. Set the program of the schedule function so that the events of My Image, Messenger and Blank can be executed when the lamp is lighting.

(continued on next page)

**9. Troubleshooting**

Item to be checked	Solutions
Is the program to be executed set correctly?	Check the settings of Schedule Settings of the Projector Web Control.
Are there any events set at the same time?	Some events cannot be executed at the same time. Set the events to be executed at the different time or change the order.

\* The schedule function may not operate correctly depending on the status of the projector.

Issue: The time settings are not correct.

Item to be checked	Solutions
Is battery set?	Set the battery. The battery is considered to be exhausted if the time is off soon after setting date and time. In that case, replace the battery.
Is the date and time set correctly?	Check the settings of Date/Time Settings menu of the Projector Web Control or DATE AND TIME menu of the projector.
Is the projector connected to the network correctly when getting the time via the network?	Connect to the network.
Is SNTP server set correctly when getting the time using the network?	Check the settings of SNTP server. Consult with your network administrator regarding the settings of SNTP server.
Is the time difference set correctly when getting the time using the network?	When getting the time using the network, the correct time is not displayed if the time difference is not set. Set the time difference.



Issue: Cannot control the external device by using Network Bridge.

Item to be checked	Solutions
Is Network Bridge settings enabled?	Check the settings in OPTION – SERVICE – COMMUNICATION – COMMUNICATION TYPE menu.
Is STANDBY MODE set to POWER SAVE?	The Network Bridge is not available when STANDBY MODE is set to POWER SAVE. Set STANDBY MODE to NORMAL, and set NETWORK BRIDGE (WIRELESS/WIRED) in the COMMUNICATION TYPE menu.
Are the serial settings set correctly?	Check the serial settings of the projector and the external device.

## 10. Warranty and after-sales service

### 10. Warranty and after-sales service

If an abnormal operation (such as smoke, strange odor or excessive sound) should occur, stop using the projector immediately.

If this does not resolve the problem, consult your dealer or service company. They tell you what warranty condition is applied.

Consult the following web address where you may find the latest information for this projector.

<http://www.christiedigital.com>

#### Trademark acknowledgment

- Microsoft® and Internet Explorer®, Windows®, Windows Vista® are registered trademark of Microsoft Corporation in the U.S. and/or other countries.
  - Adobe® and Flash® are registered trademarks of Adobe Systems Incorporated.
  - Pentium® is a registered trademark of Intel Corporation.
  - JavaScript® is a registered trademark of Sun Microsystems, Inc.
  - HDMI™, the HDMI logo and High-Definition Multimedia Interface are trademarks or registered trademarks of HDMI Licensing LLC in the United States and other countries.
  - Crestron®, Crestron e-Control®, e-Control®, Crestron Connected™, Fusion RV®, Crestron RoomView® and RoomView™ are trademarks or registered trademarks of Crestron Electronics, Inc. in the United States and other countries.
  - Trademark PJLink is a trademark applied for trademark rights in Japan, the United States of America and other countries and areas.
  - DisplayPort is a trademark or registered trademark of Video Electronics Standards Association.
- All other trademarks are the properties of their respective owners.



### Corporate offices

---

USA – Cypress  
ph: 714-236-8610

Canada – Kitchener  
ph: 519-744-8005

### Consultant offices

---

Italy  
ph: +39 (0) 2 9902 1161

### Worldwide offices

---

Australia  
ph: +61 (0) 7 3624 4888

Brazil  
ph: +55 (11) 2548 4753

China (Beijing)  
ph: +86 10 6561 0240

China (Shanghai)  
ph: +86 21 6278 7708

Eastern Europe and  
Russian Federation  
ph: +36 (0) 1 47 48 100

France  
ph: +33 (0) 1 41 21 44 04

Germany  
ph: +49 2161 664540

India  
ph: +91 (080) 6708 9999

Japan  
ph: 81-3-3599-7481

Korea (Seoul)  
ph: +82 2 702 1601

Republic of South Africa  
ph: +27 (0)11 510 0094

Singapore  
ph: +65 6877-8737

Spain  
ph: + 34 91 633 9990

United Arab Emirates  
ph: +971 4 3206688

United Kingdom  
ph: +44 118 977 8000



For the most current technical documentation,  
please visit [www.christiedigital.com](http://www.christiedigital.com)

**CHRISTIE®**