



User Manual

020-101942-02

Mirage M Series

CHRISTIE®

NOTICES

COPYRIGHT AND TRADEMARKS

Copyright ©2018 Christie Digital Systems USA Inc. All rights reserved.

All brand names and product names are trademarks, registered trademarks or trade names of their respective holders.

GENERAL

Every effort has been made to ensure accuracy, however in some cases changes in the products or availability could occur which may not be reflected in this document. Christie reserves the right to make changes to specifications at any time without notice. Performance specifications are typical, but may vary depending on conditions beyond Christie's control such as maintenance of the product in proper working conditions. Performance specifications are based on information available at the time of printing. Christie makes no warranty of any kind with regard to this material, including, but not limited to, implied warranties of fitness for a particular purpose. Christie will not be liable for errors contained herein or for incidental or consequential damages in connection with the performance or use of this material. Canadian manufacturing facility is ISO 9001 and 14001 certified.

WARRANTY

Products are warranted under Christie's standard limited warranty, the complete details of which are available by contacting your Christie dealer or Christie. In addition to the other limitations that may be specified in Christie's standard limited warranty and, to the extent relevant or applicable to your product, the warranty does not cover:

- a. Problems or damage occurring during shipment, in either direction.
- b. Projector lamps (See Christie's separate lamp program policy).
- c. Problems or damage caused by use of a projector lamp beyond the recommended lamp life, or use of a lamp other than a Christie lamp supplied by Christie or an authorized distributor of Christie lamps.
- d. Problems or damage caused by combination of a product with non-Christie equipment, such as distribution systems, cameras, DVD players, etc., or use of a product with any non-Christie interface device.
- e. Problems or damage caused by the use of any lamp, replacement part or component purchased or obtained from an unauthorized distributor of Christie lamps, replacement parts or components including, without limitation, any distributor offering Christie lamps, replacement parts or components through the internet (confirmation of authorized distributors may be obtained from Christie).
- f. Problems or damage caused by misuse, improper power source, accident, fire, flood, lightning, earthquake or other natural disaster.
- g. Problems or damage caused by improper installation/alignment, or by equipment modification, if by other than Christie service personnel or a Christie authorized repair service provider.
- h. Problems or damage caused by use of a product on a motion platform or other movable device where such product has not been designed, modified or approved by Christie for such use.
- i. Problems or damage caused by use of a projector in the presence of an oil-based fog machine or laser-based lighting that is unrelated to the projector.
- j. For LCD projectors, the warranty period specified in the warranty applies only where the LCD projector is in "normal use" which means the LCD projector is not used more than 8 hours a day, 5 days a week.
- k. Except where the product is designed for outdoor use, problems or damage caused by use of the product outdoors unless such product is protected from precipitation or other adverse weather or environmental conditions and the ambient temperature is within the recommended ambient temperature set forth in the specifications for such product.
- l. Image retention on LCD flat panels.
- m. Defects caused by normal wear and tear or otherwise due to normal aging of a product.

The warranty does not apply to any product where the serial number has been removed or obliterated. The warranty also does not apply to any product sold by a reseller to an end user outside of the country where the reseller is located unless (i) Christie has an office in the country where the end user is located or (ii) the required international warranty fee has been paid.

The warranty does not obligate Christie to provide any on site warranty service at the product site location.

PREVENTATIVE MAINTENANCE

Preventative maintenance is an important part of the continued and proper operation of your product. Failure to perform maintenance as required, and in accordance with the maintenance schedule specified by Christie, will void the warranty.

REGULATORY

The product has been tested and found to comply with the limits for a Class A digital device, pursuant to Part 15 of the FCC Rules. These limits are designed to provide reasonable protection against harmful interference when the product is operated in a commercial environment. The product generates, uses, and can radiate radio frequency energy and, if not installed and used in accordance with the instruction manual, may cause harmful interference to radio communications. Operation of the product in a residential area is likely to cause harmful interference in which case the user will be required to correct the interference at the user's own expense.

CAN ICES-3 (A) / NMB-3 (A)

이 기기는 업무용 (A 급) 으로 전자파적합등록을 한 기기이오니 판매자 또는 사용자는 이점을 주의하시기 바라며 , 가정 외의 지역에서 사용하는 것을 목적으로 합니다 .

Environmental

The product is designed and manufactured with high-quality materials and components that can be recycled and reused. **This symbol**  means that electrical and electronic equipment, at their end-of-life, should be disposed of separately from regular waste. Please dispose of the product appropriately and according to local regulations. In the European Union, there are separate collection systems for used electrical and electronic products. Please help us to conserve the environment we live in!

Content

Introduction	11
Purchase record and service contacts	11
Projector models	12
How the projector works	12
User interface overview	12
List of components	12
Key features	13
Safety warnings and guidelines	14
General Precautions	14
AC/power precautions	14
Lamp precautions	14
Product documentation	14
Related documentation	15
Installation and Setup	16
About the projector	16
Installation considerations	18
Front screen installations	19
Rear screen installations	19
Screen size	20
Ambient lighting	20
Ventilation	20
Other considerations	20
Installing a projection lens	21
Positioning the projector	22
Throw distance	23
Vertical and horizontal position	23
Mounting the projector	27
Ceiling mount	27
Special mounting	28
Stacking projectors in a frame	28
Stacking multiple projectors	29
Aligning stacked projectors	30
Adjusting projector height and tilt	31

Adjusting height	31
Adjusting tilt	31
Connecting a source	31
Connecting the line cord	32
Powering on the projector	32
Selecting a source	33
Aligning the image	33
Aligning boresight	34
Powering down the projector	36
Connect communications	37
Configuring Ethernet settings	37
Serial port connections	37
Connecting through RS232	37
Connecting through RS422	38
Connecting multiple projectors	39
Separate networks	41
Communicating to all ports	41
Connecting to the GPIO connector	42
Configuring the GPIO	43
Connecting sources through option cards	44
LEDs	44
Twin HDMI input card	44
Analog BNC input card	45
Dual 3G/HD/SD-SDI input card	45
Dual link DVI input card	45
Video decoder input card	46
DMXC interface card	46
Twin DisplayPort input card	47
Configuring the output options cards	47
Connecting tiled projectors	48
Defining the communication method between projectors	51
Specifying serial communication parameters	51
Adding a serial command	52
Configuring DMX512 support	52
Adding a DMX channel event	54
Operating the projector	55
Controlling the projector	55
Built-in keypad	56

Wired remote	56
IR remote keypad	57
Managing users	58
Creating a user	58
Changing a password	58
Deleting a user	58
Uploading a logo file	58
Logging on	59
Setting the power management parameters	60
Setting the date and time	61
Navigating the interface	61
Changing the language used for menus	61
Adjusting the menu appearance	61
Selecting an input or channel	63
Creating a new channel	64
Selecting a channel	64
Displaying a list of channels	65
Copying a channel	66
Deleting a channel	66
Deleting multiple channels	66
Editing a channel	67
Configuring the lens	67
Configuring up the lamp	68
Selecting the lamp operation mode	68
Selecting the lamp mode	68
Specifying the amount of power sent to the lamp	69
Setting the target brightness	69
Configuring lamp failover	69
Using multiple projectors	69
Tiling an image over multiple screens	69
Performing preliminary calibration	70
Automatically correct frame delay issues in tiled images	70
Matching colors across multiple screens	71
Refining the displayed colors	71
Matching colors across multiple screens	73
Displaying picture-in-picture	73
Enabling picture-in-picture	73
Selecting the main and picture-in-picture inputs	73

Swapping the main and picture-in-picture inputs	73
Changing the size and position of picture-in-picture	74
Configuring the picture-in-picture image	74
Fading between images	74
Locking image frames to the input	74
Automatically searching for input signals	74
Configuring the HDMI output options	74
Looping video signals	75
3D	75
Requirements	75
Connecting the 3D stereo sync cable	76
Active and passive Stereo 3D configurations	77
3D settings	78
Performing diagnostics and calibration	83
Adjusting the image	85
Automatically optimizing display parameters	85
Selecting a test pattern	86
Changing the size and position of the image	86
Resize presets	86
Configuring how an image is cropped	89
Adjusting an image for keystone correction	90
Adjusting the main image	91
Configure the video sources	92
Manually optimize input levels	94
Correcting gamma settings	96
Adjusting the sharpness of the image	96
Selecting the noise reduction filter	97
Adjusting the color for the output	97
Selecting a color space	98
Changing color performance	98
Defining user color gamuts	99
Adjusting the color saturation	99
Ensuring brightness uniformity	100
Creating a seamless image with edge blending	102
Adjusting the intensity of black	104
Uploading a gamma file	105
Monitoring and Maintenance	106

Backing up the projector configuration and preferences	106
Creating a backup file	106
Restoring a backup file	106
Performing a diagnostic test using interrogator	107
Monitoring the projector	107
Viewing the projector status	107
Alarm conditions	107
Configuring SNMP	108
Adding a scheduled event	110
Adding a system event	111
Adding a GPIO event	111
Adding a function key event	111
LED and key states	111
Status LEDs	112
Maintaining the cooling system	113
Ventilation	113
Maintaining the optics	114
Viewing the lamp history	114
Notifying users after a set number of hours of lamp use	115
Replacing the lamps	115
Changing the lamp serial number	116
Optical (excluding lens)	116
Supplies or cleaning optical surfaces	116
Clean the projection lens	116
dust from the projection lens	117
Removing fingerprints, smudges, or oil from the projection lens	117
Troubleshooting	118
Power	118
Projector does not power on	118
Lamp	119
Lamp does not ignite	119
Lamp suddenly turns off	119
Flicker, shadows or dimness	119
LCD	119
Blank screen, no menu display	119
Remote keypad	120
Remote keypad does not seem to work	120
On-screen display	120

The on-screen display menu does not display	120
Ethernet	120
Cannot establish communication with projector	120
Display	121
The projector is on but there is no display	121
Severe motion artifacts	121
Image appears squeezed or vertically stretched into center of screen	121
The display is jittery or unstable	121
The display is faint	122
The upper portion of the display is waving, tearing or jittering	122
Portions of the display are cut off or warped to the opposite edge	122
Display appears compressed (vertically stretched)	122
Data is cropped from edges	122
Display quality appears to drift from good-to-bad, bad-to-good	122
Display suddenly freezes	123
Colors in the display are inaccurate	123
Display is not rectangular	123
Display is noisy	123
Web interface	123
After a projector software upgrade, the web pages do not display correctly	123
A backup or interrogator file cannot be saved	124

Specifications 126

Pixel format	126
Contrast	126
Gamma	126
Grayscale/color resolution	126
Color temperature	127
Input source signal compatibility	127
Analog-only input	127
Twin HDMI input	127
Dual Link DVI Input	127
Video Decoder input	129
Dual 3G/HD/SD-SDI	129
DisplayPort input	129
Power requirements	129
Physical specifications	131
Size	131
Weight	131

Environment 131
 Temperature/humidity/altitude 131
Regulatory 131
 Safety 131
 Electro-magnetic compatibility 132
 Environmental 132
 Marking 132

Appendix: DMX/ArtNET 133

DMX and real time events 133
 Lens control limitations 133
DMX channel setup 134
 Mirage M Series setup personality 135
 Mirage M Series show personality 140
 Mirage M Series Nitro VIP projector yoke personality 142

Introduction

This manual is intended for trained users operating professional high-brightness projection systems. Such users may also be trained to replace the lamp and air filter, but cannot install the projector or perform any service functions on the M Series projector.

Only Christie accredited technicians knowledgeable about all potential hazards associated with high voltage, ultraviolet exposure and high temperatures generated by the lamp and associated circuits are authorized to assemble/install the projector and perform service functions inside the projector.

Purchase record and service contacts

Whether the projector is under warranty or the warranty has expired, Christie's highly trained and extensive factory and dealer service network is always available to quickly diagnose and correct projector malfunctions. Complete service manuals and updates are available for all projectors. Should a problem be encountered with any part of the projector, contact your dealer. In most cases, servicing is performed on site. If you have purchased the projector, fill out the information below and keep with your records.

Dealer:
Dealer or Christie Sales/Service Contact Phone Number:
Projector Serial Number*:
Purchase Date:
Installation Date:

* The serial number can be found on the license label located on the back of the projector.

Default Gateway:
DNS Server:
Projector DLP Address:
Projector Mgmt IP Address:
Subnet Mask:

Projector models

The Mirage M Series is a family of high resolution video/graphics three chip 1080p HD, SXGA+, and WUXGA projectors. These projectors are based on next generation DLP™ technology provided by Texas Instruments.

Model name	Part number
Mirage DS+10K-M2	118-053109-XX
Mirage DS+14K-M2	118-050117-XX
Mirage HD10K-M2	118-051107-XX
Mirage HD10K-M2 (Runco Model)	118-051208-XX
Mirage HD14K-M2	118-059105-XX
Mirage WU12K-M2	118-055101-XX
Mirage WU14K-M2	118-051118-XX

How the projector works

The projector accepts data/graphics and video input signals for projection onto front or rear screens. Light is generated by dual mercury lamps, then modulated by three Digital Micro-mirror Device (DMD) panels that provide digitized red, green or blue color information. Light from the ON pixels of each panel is reflected, converged, and then projected to the screen through a single front lens, where all pixels are perfectly superimposed as a sharp full-color image.

User interface overview

The projector is controlled through a menu system displayed on the image. The menu system is controlled by an IR remote, wired remote, or through the built-in keypad. The LCD screen and built-in keypad allow some functions to be controlled without the need of an on-screen display, and provide an accessible interface to view error reporting. The functions on the on-screen display can also be controlled using the Christie Serial Protocol, through a serial or Ethernet connection to the projector. The web interface provides access to the menu system as a virtual on-screen display and to features that maintain the software and settings.

List of components

Ensure the following components were received with the projector:

- IR remote keypad
- Line cord
- Lens Mount Security Screw (M6x10mm long, Qty. 2)
- Lens Mount Security Screw (5mm Hex, Qty. 1)
- Warranty Card
- Web Registration Form

Key features

- Up to 14,000 lumens
- HD (1080p), SXGA+, or WUXGA resolution
- Dual Mercury lamp illumination with 350 W and 450 W options
- Contrast aperture providing up to 10,000:1 contrast ratio (available on 350 W models)
- Ultra-compact design and weighs less than 55 lbs
- 10-bit image processor electronics with modular design
- Fully sealed optical system
- Active fan control for minimum noise level
- Selectable, motorized Yellow Notch Filter for expanded color gamut
- User interchangeable projection lenses with no-tool mounting
- Picture-in-picture (PIP)
- LiteLOC™ for constant brightness maintenance
- Intelligent Lens System (ILS)
- Motorized lens mount for all models
- Auto-setup feature
- Integrated ChristieNET
- Networking ability through RS232 and RS422 connectors
- Status LED display on built-in keypad for easy projector status monitoring
- Control with remote keypad, wired remote, or built-in keypad
- Four input slots for Optional Input Modules

Safety warnings and guidelines

General Precautions



Danger! Failure to comply with the following results in death or serious injury.

- FIRE HAZARD. Keep hands, clothes and all combustible material away from the concentrated light beam of the projector. Position all cables where they cannot contact hot surfaces or be pulled or tripped over.



Warning! Failure to comply with the following could result in death or serious injury.

- All installation and maintenance procedures must be performed by a Christie qualified technician.
- Projector must be operated in an environment that meets operating specifications.

AC/power precautions



Warning! Failure to comply with the following could result in death or serious injury.

- Use only the AC power cord supplied. Do not attempt operation if the AC supply and cord are not within the specified voltage and power range. See the license label on the back of the projector for rated voltage and power.
- The projector is equipped with a three-wire plug with a grounding pin. This is a safety feature. If you are unable to insert the plug into the outlet, contact an electrician to have the outlet replaced. Never defeat the safety purpose of the grounding-type plug.
- Do not allow anything to rest on the power cord. Locate the power cord where persons walking on it or objects rolling over it cannot damage the cord.

Lamp precautions



Warning! Failure to comply with the following could result in death or serious injury.

- Never attempt to access the lamp while the lamp is on. After turning the lamp off, it is crucial that you wait at least 10 minutes before handling the lamp. This provides sufficient time for the lamp cooling fans to properly cool the lamp.

Product documentation

For installation, setup, and user information, see the product documentation available on the Christie website. Read all instructions before using or servicing this product.

1. Access the documentation from the Christie website:
 - Go to this URL: bit.ly/2C6H4HZ or <https://www.christiedigital.com/en-us/business/products/projectors/3-chip-dlp/3d-projectors>.

- Scan the QR code using a QR code reader app on a smartphone or tablet.

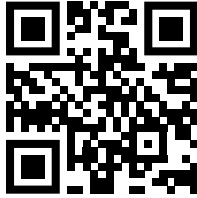

2. On the product page, select the model and switch to the **Downloads** tab.

Related documentation

Additional information on the projector is available in the following documents.

Mirage M Series Installation and Setup Guide (P/N: 020-101944-XX)

M Series Product Safety Guide (P/N: 020-102690-XX)

M Series Service Guide (P/N: 020-100551-XX)

M Series Serial API Commands Technical Reference (P/N: 020-100224-XX)

Installation and Setup

This section explains how to install, connect, and optimize the projector for delivery of superior image quality.



Danger! Failure to comply with the following results in death or serious injury.

- Always power down the projector and disconnect all power sources before servicing or cleaning.

About the projector

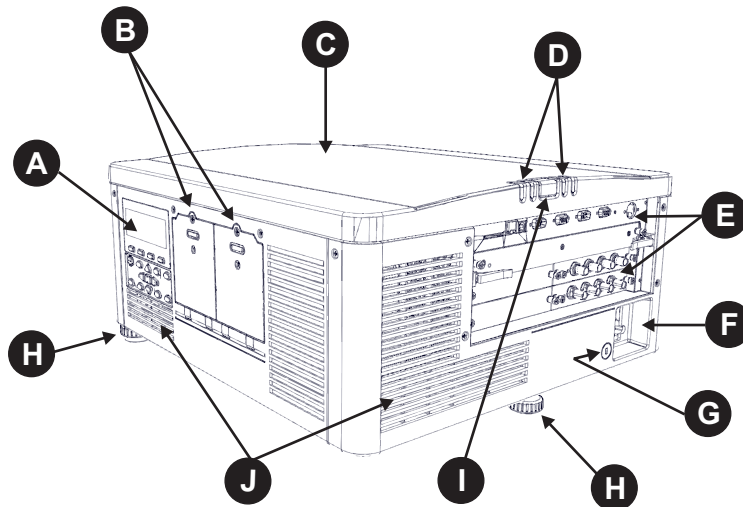

A	Built-in keypad	The built-in keypad is located on the side of the projector. Use it similarly to the IR remote to control the projector. An LCD display is located above the keypad for displaying projector status.
B	Lamp doors	The lamp doors are located at the side of the projector, which provides easy access to the lamp module for replacement. The lamp doors are fitted with safety interlocks which switch the lamp off when the door is opened. The lamp doors are provided with clear windows to indicate when the lamps are on.
C	Top cover	—
D	LED status indicators	See LED and key states on page 111.

E	Input panel	All source connections are made to the input panel located at the back of the projector. Any of the available optional input cards can be installed in the four option card slots. The slots are labelled 1 through 4. All option cards have LEDs to indicate their status.
F	AC receptacle	The AC receptacle is located above the AC receptacle at the back of the projector. Use this receptacle to plug in an appropriately rated line cord.
G	Kensington lock	Located at the rear of the projector to the left of the AC receptacle, is a Kensington lock attachment point. This provides the ability to secure the projector against possible theft.
H	Adjustable feet	Located on the underside of the projector are three adjustable feet. Raise or lower these feet when positioning the projector to ensure it is level on all sides so the displayed image appears rectangular without any keystone. For instructions on how to adjust the projector feet see Adjusting height on page 31.
I	Rear IR sensor	The two IR sensors receive transmissions from the IR remote from up to 100 feet away. It is important to keep the transmission path to these sensors unobstructed for uninterrupted communications with the projector. The rear IR sensor is located at the back of the projector between the status LEDs. The front IR sensor is located next to the front nameplate.
J	Cooling air vents	There are numerous air vents located around the projector. These vents must remain unobstructed to allow adequate airflow through the projector and prevent it from overheating.

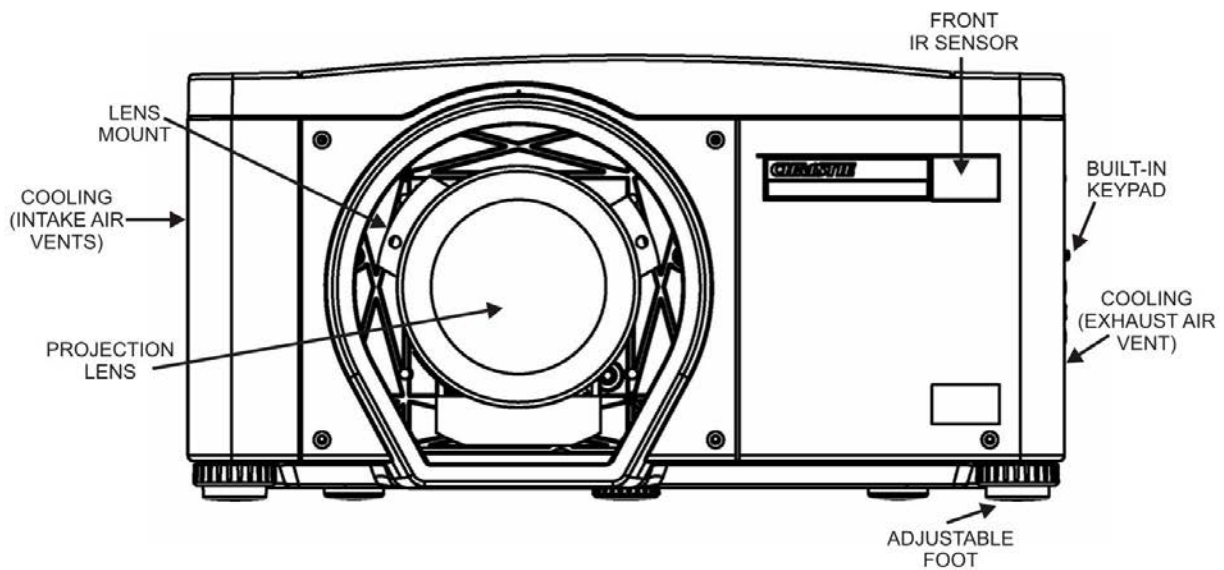

Projection lenses, lens mount and other features

The projector includes a motorized lens mount that allows automated lens control and adjustment: vertical and horizontal offsets, zoom and focus. The projection lens is shipped separately from the projector. Use the lens cap when transporting the lens to avoid scratching and damaging the lens, which could affect your displayed image.

Motorized lenses should not be adjusted by hand without first setting them for manual operation, otherwise the zoom and focus motors may be damaged.

- **Zoom and Focus:** Two internal lens motors allow for quick motorized adjustment of zoom and focus. Adjust zoom to fit the displayed image on the screen and adjust focus to improve the clarity of the image.
- **Lens Offset:** The motorized lens mount allows vertical and horizontal offset of the displayed image.
- **Shutter:** Allows the screen to become absolute black, when in the closed state.

Installation considerations

Proper installation of the projector ensures the quality of the display. Whether installing a projector temporarily or permanently, take the following into account to make sure the projector performs optimally. Choose the installation type that best suits your needs: front or rear screen, floor mount, or inverted mount.

Front screen/floor mount installations

Advantages	Considerations
<ul style="list-style-type: none"> • Easy to set up. • Can be moved or changed quickly. • Easy to access. 	<ul style="list-style-type: none"> • Shares floor space with audience.

Front screen/inverted mount (ceiling) installation

Advantages	Considerations
<ul style="list-style-type: none"> • Does not take up audience space. • Projector is unobtrusive. • Projector cannot be accidentally moved. 	<ul style="list-style-type: none"> • Installation is more permanent. • It is more difficult to access the projector.

Rear screen/floor mount installation

Advantages	Considerations
<ul style="list-style-type: none"> • Projector is completely hidden. • Projector is easily accessed. • Usually good ambient light rejection. 	<ul style="list-style-type: none"> • Requires separate room or enclosure. • Installation cost is usually higher.

Rear screen/inverted mount (ceiling) installation

Advantages	Considerations
<ul style="list-style-type: none"> • Projector is completely hidden. • Usually good ambient light rejection. 	<ul style="list-style-type: none"> • Requires separate room. • Installation cost is usually higher. • More difficult to access projector.

Rear Screen/Floor Mount with Mirror

Advantages	Considerations
<ul style="list-style-type: none"> • Projector is completely hidden • Usually good ambient light rejection. • Requires less space behind screen than other rear screen installations. 	<ul style="list-style-type: none"> • Requires separate room or enclosure. • Installation cost is usually higher. • More involved to perform setup.

Front screen installations

In front screen installations, the projector and audience are positioned in front of the screen, which can be flat or curved.

Flat screens offer a gain of about 1.0 with a viewing angle just less than 180 degrees. This type of screen reflects incident light equally in all directions so the audience can see the display from various angles.

Curved screens have a gain greater than 1.0 with a viewing angle much less than 180 degrees. This type of screen does not reflect incident light equally in all directions; instead it is concentrated in a viewing cone. The audience sitting within the viewing cone area see a brighter image than those sitting just outside the area.

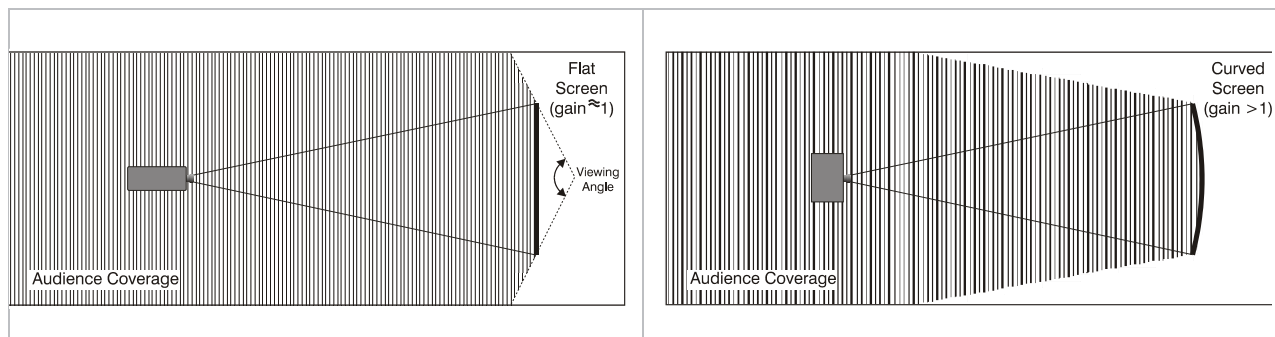

Rear screen installations

There are two basic types of rear screens:

- **Diffused**—A diffused screen has a surface which spreads the light that strikes it. Purely diffused screens have a gain of less than 1.0. The advantage of the diffused screen is its wide viewing angle, similar to that of a flat screen for front screen projection. This type of screen is suitable when a wide viewing angle is required but there is low ambient room lightening.

- **Optical**—Optical screens take light from the projector and redirects it to increase the light intensity at the front of the screen and reduce it in other areas. A viewing cone, similar to that of a curved front screen installation is created. This type of screen is better suited for brightly lit rooms where the audience is situated within the viewing cone.

Screen size

Choose a screen size appropriate for your lens and application. If the projector is used to display text information, the image size must allow the audience to recognize all text clearly. The eye sees a letter clearly if eye-to-text distance is less than 150 times the height of the letter. Small text located too far from the eye is illegible at a distance no matter how sharply and clearly it is displayed.

To fill a screen with an image, the aspect ratio of the screen should be equal to the aspect ratio of the image (expressed as the ratio of its width to its height). Standard video from a VCR has a 4:3 or 1.33:1 aspect ratio. For example, to display a VCR output with a 4:3 aspect ratio onto a 10 foot (3 m) high screen, the width of the screen must be at least 13.3 feet (4 m).

Ambient lighting

The high brightness of this projector is well suited for locations where ambient lighting might be considered less than ideal. A typical room with ceiling lights and windows rarely requires special attention. Contrast ratio in your images is reduced if stray light directly strikes the screen.

For example, when a shaft of light from a window or floodlight falls on the image, the image may appear washed out and less vibrant. Avoid or eliminate stray light sources directed at the screen.

Ventilation

The projector vents and louvers provide ventilation, both for intake and exhaust. Never block or cover these openings. Do not install the projector near a radiator or heat register, or within an enclosure. To ensure adequate airflow around the projector, allow free air exchange to the projector with a minimum clearance of 25 cm (10 inch) on the left, right and rear sides of the projector from any walls or other obstructions. Never obstruct the air exchange to the projector.

Other considerations

Other considerations and tips to improve your installation:

- Keep the ambient temperature constant and below 40°C (104°F). Keep the projector away from heating and/or air conditioning vents. Changes in temperature may cause drifts in the projector circuitry, which may affect performance.
- Keep the projector away from devices that radiate electromagnetic energy, such as motors and transformers, slide projectors, speakers, power amplifiers, elevators, for example.
- Use a screen size appropriate for the venue but not larger than required. Installing a large screen in a small room is similar to watching television at a close range; too large a screen can overpower a room and interfere with the overall effect. As a rule, be no closer than 1.5 times the width of the screen.

Installing a projection lens

The projection lens, shipped separately from the projector, must be installed prior to setting up the projector.



Warning! Failure to comply with the following could result in death or serious injury.

- Remove the lens plug from the lens opening in the projector before installing the lens. Retain the lens plug for projector transportation to protect the optical components from dust and debris.



Notice. Failure to comply with the following may result in property damage.

- The lens seals the projector, preventing contaminants from entering the interior of the projector. Never operate a projector without a lens. Remove the rear lens cap from the lens. Keep the front lens cap on the lens to protect it during installation.
- When installing the lens, ensure that the lens is not inserted at an angle, as this can cause damage.

1. Rotate the lens clamp to the open position, as shown.

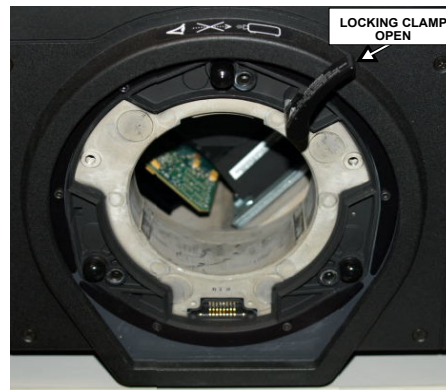

2. Align the lens interface plate with the lens mount and align the lens electrical connector with the mating connector on the lens mount.
3. Fully insert the assembly straight into the lens mount opening without turning and press with your hand as shown.



4. While holding the lens flat against the lens mount, rotate the lens clamp clockwise to lock the lens assembly in place.



5. Remove the front lens cap.
6. For added stability such as motion application, fasten the security screws provide with the lens-mount.



7. Use a 5mm hex driver to fasten the red security screws provided with the lens mount, or hand tighten the lens retaining screws attached to the lens. Christie recommends this for heaviest lenses such as 0.73:1 and 1.2:1.
8. If the projector is hoisted or installed in an overhead position use the lens red security screws or the lens retaining screws.

Positioning the projector



Warning! Failure to comply with the following could result in death or serious injury.

- Two people are required to safely lift and install the projector.

Place the projector on a sturdy, level surface and position it so that it is perpendicular to the screen at a suitable distance. The further back the projector is positioned for the screen, the larger the image becomes.

To level the projector adjust its three feet. With the projector positioned perpendicular to the screen the image appears rectangular instead of keystone.

Throw distance

Throw distance is the distance measured from the front feet of the projector to the screen. This calculation determines if there is enough room to install your projector with a desired screen size and if the image is the right size for your screen.

Use the lens and screen size to calculate the precise throw distance using the lens throw calculator provided in the Dealer Section of the Christie website, or use the tables provided in the [M Series Lens Throw Ratios document \(P/N: 020-100221-XX\)](#). Due to lens manufacturing tolerances for lens focal length, actual throw distance can vary $\pm 5\%$ between lenses with the same nominal throw ratio.

To estimate the throw distance take the horizontal width of the screen and multiply it by the lens throw ratio. The result determines approximately the distance the projector should be positioned from the screen to project a focused image large enough to fill the screen. For example, using a 0.73:1 lens, throw distance would roughly be 0.73 times the screen width.

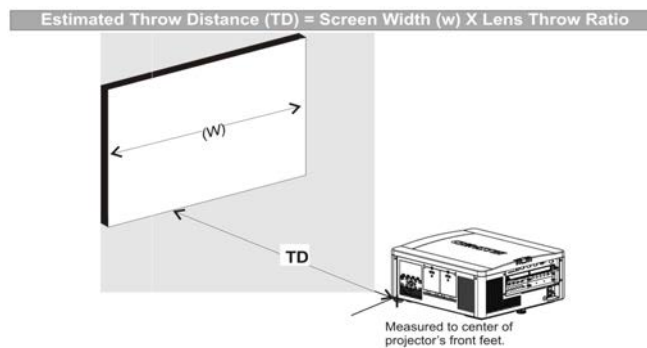

Vertical and horizontal position

The correct vertical and horizontal position of the projector in relation to the screen depends on the lens type and the screen size. Ideally, the projector should be positioned perpendicular to the screen. This way, the image appears rectangular instead of keystone (trapezoidal).

The vertical position of the image can be offset (moved above or below the optical axis) by adjusting the motorized lens mount. The amount of vertical offset available depends on the type of lens installed in the projector and can be limited if horizontal offset has been applied. Vertical offset can be expressed as the percent of half the image height or the number of pixels of shift from lens center.

- Offsets are subject to $\pm 7\%$ centering tolerance.
- % Offset = number of pixels of offset/half vertical panel resolution x 100.

WUXGA Vertical Offset Ranges

WUXGA lens description	Lens part number	Minimum offset above or below lens center	
Lens ILS 0.73:1SX+/0.67:1HD	118-100110-XX	$\pm 22\%$	± 132 pixels
Lens ILS 1.25-1.6SX+/1.16-1.49HD	118-100111-XX	$\pm 82\%$	± 492 pixels
ALL OTHER LENSES		$\pm 112\%$	± 672 pixels

HD 1080p Vertical Offset Ranges

HD 1080p lens description	Lens part number	Minimum offset above or below lens center	
Lens ILS 0.73:1SX+/0.67:1HD	118-100110-XX	±35%	±189 pixels
Lens ILS 1.25-1.6SX+/1.16-1.49HD	118-100111-XX	±102%	±551 pixels
ALL OTHER LENSES		±119%	±643 pixels

SXGA+ Vertical Offset Ranges

SXGA+ lens description	Lens part number	Minimum offset above or below lens centers	
Lens ILS 0.73:1SX+/0.67:1HD	118-100110-XX	±23%	±121 pixels
Lens ILS 1.25-1.6SX+/1.16-1.49HD	118-100111-XX	±73%	±383 pixels
ALL OTHER LENSES		±100%	±525 pixels



Notice. Failure to comply with the following may result in property damage.

- Offsets are subject to ±7% centering tolerance.
- % Offset = number of pixels of offset/half vertical panel resolution x 100.

The horizontal position of the image can also be offset (that is moved to the left or right of optical center) by adjusting the motorized lens mount. The amount of horizontal offset available depends on the lens installed and if the image has already been vertically offset. Horizontal offset can be expressed as the percent of half the image width or the number of pixels of shift to one side of lens center.

- Offsets are subject to ±7% centering tolerance.
- % Offset = number of pixels of offset/half horizontal panel resolution x 100.

WUXGA Horizontal Offset Ranges

WUXGA lens description	Lens part number	Minimum offset above or below lens center	
Lens ILS 0.73SX+/0.67HD	118-100110-XX	±6%	±58 pixels
Lens ILS 1.25-1.6SX+/1.16-1.49HD	118-100111-XX	±38%	±365 pixels
ALL OTHER LENSES		±54%	±518 pixels

HD 1080p Horizontal Offset Ranges

HD 1080P lens description	Lens part numbers	Minimum offset above or below lens center	
Lens ILS 0.73:1SX+/0.67:1HD	118-100110-XX	±12%	±115 pixels
Lens ILS 1.25-1.6SX+/1.16-1.49HD	118-100111-XX	±40%	±384 pixels

HD 1080P lens description	Lens part numbers	Minimum offset above or below lens center	
ALL OTHER LENSES		±42%	±403 pixels

SXGA+ Horizontal Offset Ranges

SXGA+ lens descriptio	Lens part numbers	Minimum offset above or below lens centre	
Lens ILS 0.73:1SX+/0.67:1HD	118-100110-XX	±13%	±91 pixels
Lens ILS 1.25-1.6SX+/1.16-1.49HD	118-100111-XX	±45%	±315 pixels
ALL OTHER LENSES		±50%	±350 pixels

Examples of Vertical Offset (SXGA+ pixels represented)

Where:

Shaded area = projected image

Area within solid line = projected image area with no offset applied

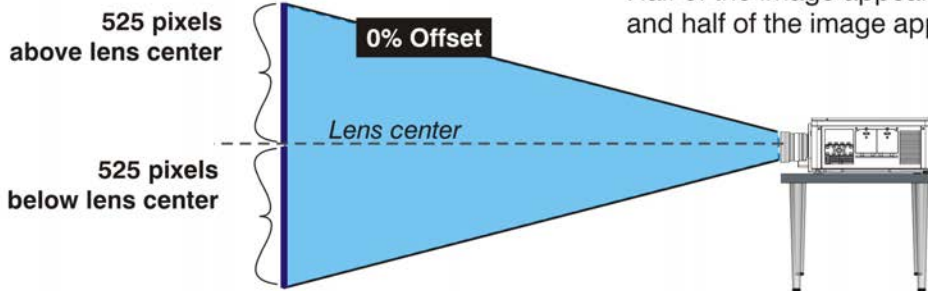

#1 In this example, no offset is applied. Half of the image appears above lens center and half of the image appears below.

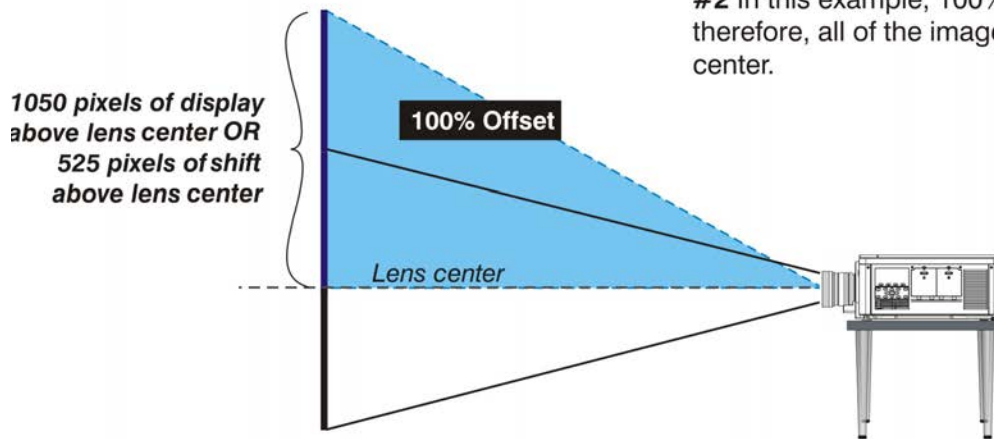

#2 In this example, 100% offset is applied; therefore, all of the image appears above lens center.

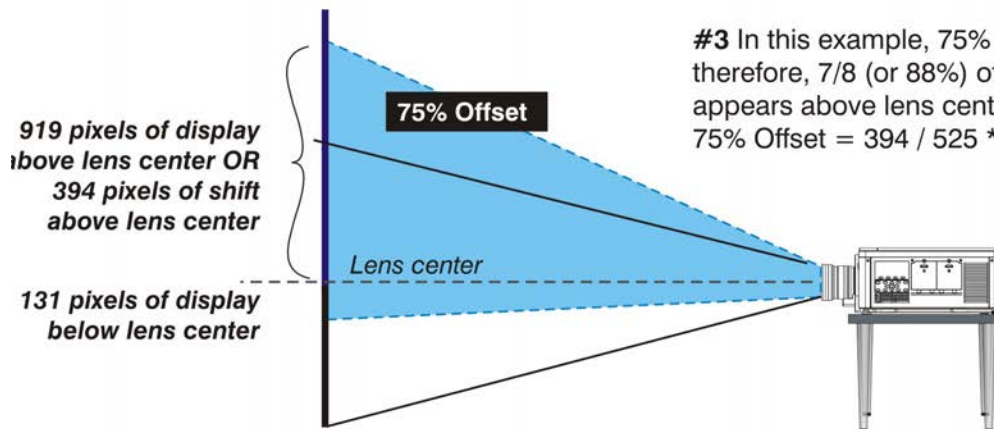

#3 In this example, 75% offset is applied; therefore, 7/8 (or 88%) of the projected image appears above lens center.
75% Offset = $394 / 525 * 100$

Examples of Horizontal Offset (SXGA+ pixels represented)**Where:**

Shaded area = projected image

Area within solid line = projected image area with no offset applied

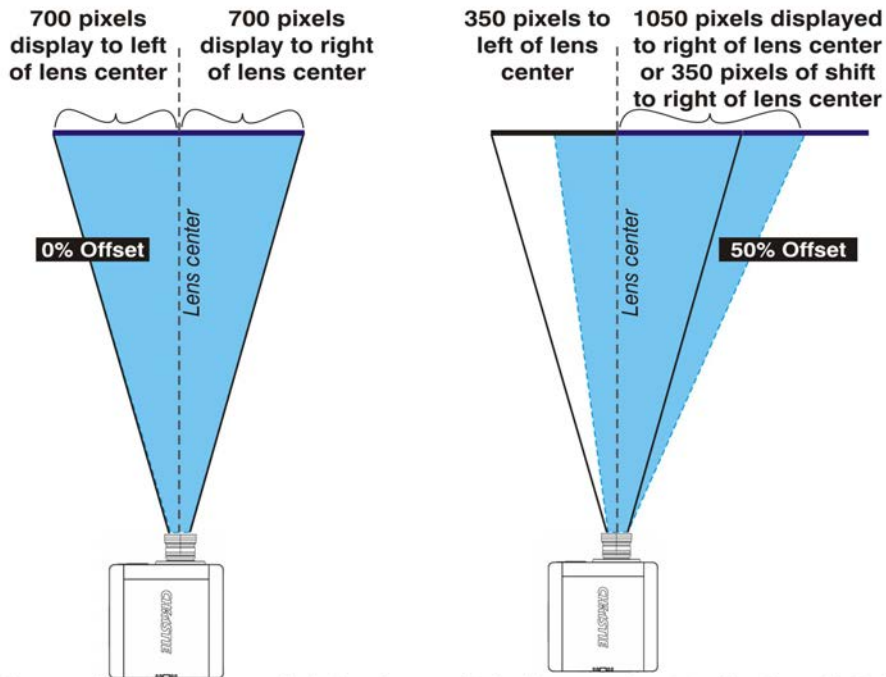

#1 In this example, no offset is applied; therefore, half of the image appears to the left of lens center and half appears to the right.

#2 In this example, 50% offset is applied; therefore, 3/4 or 75% of the image appears to the one side of the lens center.

Mounting the projector

There are several methods for mounting the projector. In typical front and rear screen installations the projector can be mounted to a secure and level surface, such as a table or cart. Carts are useful when the projector has to be moved often. To prevent accidental movement during a presentation, lock the wheels on the cart.

Ceiling mount



Warning! Failure to comply with the following could result in death or serious injury.

- Use only the Christie approved ceiling mount kit designed for your projector.

The projector can be inverted and suspended from the ceiling using a specially designed ceiling mount fixture P/N: 118-100108-XX. Christie recommends this mounting for installations that want the projector out of sight or have limited amount of space for the projector. For more information, contact your dealer.

Special mounting

The projector can be rotated (front-to-back) up to 360 degrees and fixed in a rotated position without affecting performance. However, to ensure optimal performance of the projector the side-to-side tilt limit of the projector must not exceed +/-15 degrees.

Stacking projectors in a frame

The Mirage M Series projectors can be stacked up to a maximum of three projectors high using the Christie stacking frame (P/N: 118-100107-XX).

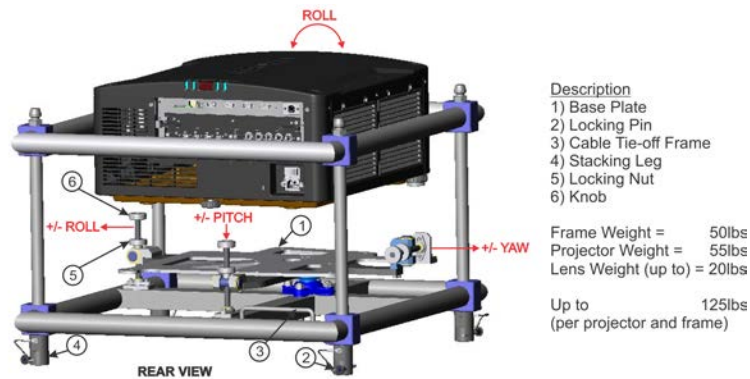

1. Turn the projector off and disconnect the AC power cord after the cooling fans have stopped.
2. Make sure the base plate is flat.
3. Place the projector into the stacking frame from the top or from the front.
4. Prior to placing the projector from the front make sure the pitch is to its maximum.
5. Make sure the bottom base plate of the frame is aligned with the projector.

- Use a 6 mm Allen key to tighten the six M8 bolts securing the base plate to the bottom of the projector.

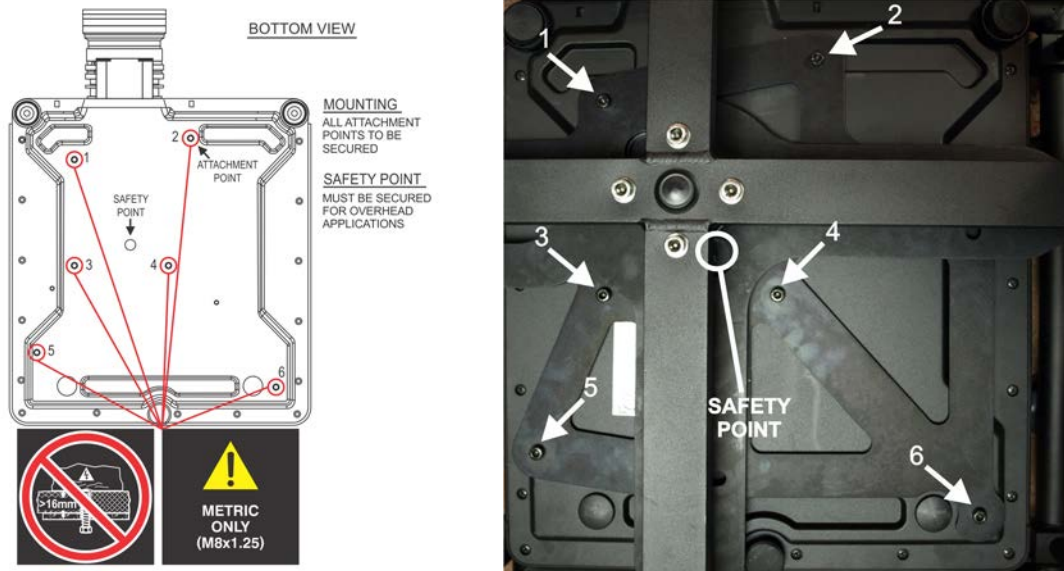

- When flying projectors overhead use the M8 safety point.

Stacking multiple projectors

The projectors can be stacked and hoisted in either an upright or inverted positions. Remove the locking pin from each stacking leg prior to alignment and ensure the four stacking legs are fully seated on the lower stacking frame.

- With one person positioned on each side of the stacking frame, lift the top stacking frame onto the bottom stacking frame, aligning all four stacking legs between the frames.



Warning! Failure to comply with the following could result in death or serious injury.

- Failure to engage the locking pin may cause the projectors to separate.

- Insert the locking pin through the holes in the stacking legs. Make sure each pin is fully inserted.

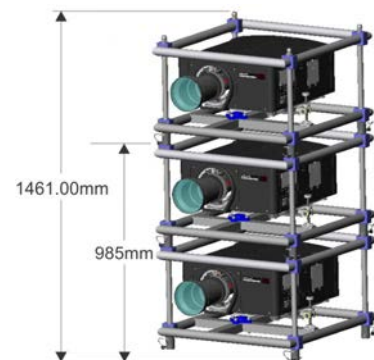

The steel ball on the end of the pin keeps the pin from releasing inadvertently.

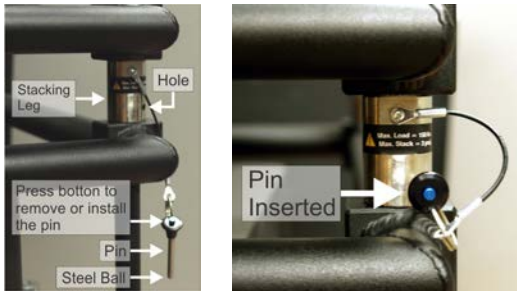

3. When required, repeat steps 1 and 2 for the additional projectors in the stack.

Aligning stacked projectors

Stacked projectors must be correctly aligned to one another so the resulting display is optimized. If hoisting the stack, do so first and then align.

1. Prior to aligning the image, turn the locking nut to unlock then use the knob to adjust the image.
2. To align the image, use pitch, yaw, or roll.

Pitch: Move the image up and down.

Roll: Rotates the image clockwise and counter-clockwise.

Yaw: Moves the image left and right.

If the projector is parallel to the screen, some keystone is introduced with Pitch and Yaw adjustment.

3. Ensure to lock the locking nut to maintain the image adjustment.

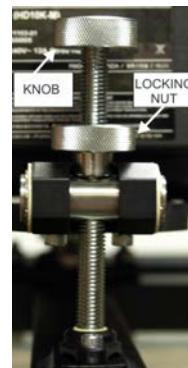
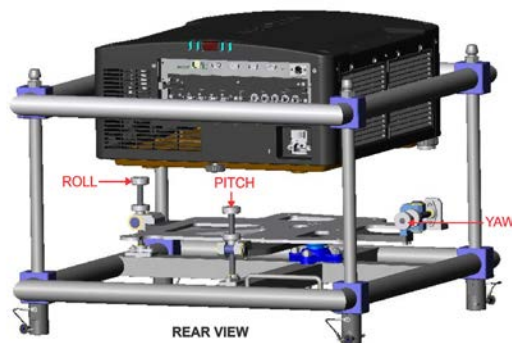

Adjusting projector height and tilt

Adjusting height

You can modify the height of the projector to remedy a slightly uneven mounting surface by adjusting the three feet threaded into the bottom chassis. Turn each foot clock-wise or counter-clockwise until the projector is level on all sides.

The front feet are adjusted by turning the collar and the feet do not rotate when adjusted. The rear foot is adjusted by turning the entire foot.

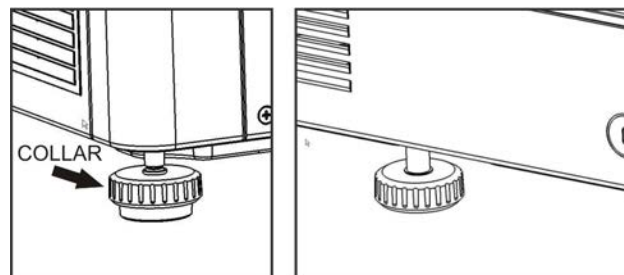

Adjusting tilt

1. Before adjusting tilt, ensure the projector is centered.

Check with site personnel for the degree of screen tilt, or measure this incline with a protractor at the screen.

2. Tilt the projector to closely match the screen tilt angle by extending or retracting the three adjustable feet.

For an ideal installation, the lens surface should be centered and parallel to the screen to help ensure optimized lens performance with minimal offset. Choose a sturdy mounting surface that allows for this. If this position is not possible (such as when the projector is significantly higher than the center of the screen), Christie recommends relying on offset rather than extra tilt.

Connecting a source

The input panel where all source connections are made, is located at the back of the projector. Each input is clearly labeled for easy identification. Depending on the type of option card installed, connect your source using the appropriate cable(s), as follows:

Option card	Connection
Analog Input Card	Connect three-, four-, or five-wire RGB source to Red/Pr, Green/Y, Blue/Pb, H/C and V using three, four or five BNC connectors as required.
Dual 3G/HD/SD-SDI input card	Connect the SDI (Serial Digital Interface) cable to one of the two inputs, 1-IN or 2-IN. Both standard-definition (SD) and high-definition (HD) signals are accepted and automatically recognized on either input.

Option card	Connection
Dual Link DVI input card	Connect a single or dual DVI video signal to the DVI-I connector, an analog video signal to the DVI-I connector, or an analog video signal to the VGA connector. The DVI signal may contain HDCP (High-Bandwidth Digital Content Protection).
Twin DHDMI input card	Connect HDMI (High-Definition Multimedia Interface) cable to one of the two inputs, 1-IN or 2-IN.
Video Decoder input card	Depending on the source you can apply the following: <ul style="list-style-type: none"> • Composite video source to 1-CVBS, using a BNC Cable — the same signal can be used on 4, 5, or 6 when input is selected as CVBS. • A component signal on Inputs 4(Pr), 5(Y), 6(Pb) using BNC Connectors — grouped as a component input, YPbPr, • S-Video to one of the two, 2-SVID or three-SVID using S-Video cable. • S-Video using two BNC cables, with Luma (Y) connected to 4 (Sy) and Chroma (C) connected to 6 (Sc) — must be grouped as one S-Video + one CVBS.
DMX512 interface card	Has two 5pin XLR connectors - one (input) male and one (output) female. If there is active communications on the DMX512 Interface card the power LED will blink between low intensity and high intensity.
TwinDisplay input card	Accepts DisplayPort 1.1a inputs from one or two DisplayPort sources.

See [Connecting sources through option cards](#) on page 44 for more details.

Connecting the line cord



Warning! Failure to comply with the following could result in death or serious injury.

- Do not attempt operation if the AC supply and cord is not within the specified ratings. Use the line cord provided with the projector, or ensure you are using a line cord, power plug, and socket that meet the appropriate rating standards. Voltage and current requirements are listed on the license label, located at the back of the projector.
- On power down, wait 5-10 minutes for the fans to turn off before unplugging the projector. Always switch off the projector before unplugging the AC line cord.

1. Connect the projector line cord to the AC receptacle at the AC inlet of the projector.
2. Push the wire clip over the plug to retain it. This prevents the line cord from inadvertent disconnection.
3. Plug the three-pronged plug end into a suitably rated grounded AC receptacle.
4. Switch the projector ON. The switch is located just above the AC receptacle.

Powering on the projector

After the AC Power has been switched on, the LCD display above the keypad indicates *Please wait* and the four LED status indicators on the top cover window switch on to amber. These indicate that the projector is changing its state from powered down to standby. The message *Standby Mode* appears in the display when the projector has completed its initialization and is ready for power up.

The two lamp status LEDs go off to indicate that the lamps are off. The Power status LED shows amber, indicating that the projector is in standby mode. The shutter LED displays amber, indicating the shutter is closed. For a full description of the status indicator, see [Connecting sources through option cards](#) on page 44.

1. Press and hold **Power** on the keypad or remote for two seconds, or press twice quickly.

The lamps power on and the fans turn on.

The default settings for the projector are to perform a lens calibration after the insertion of a new lens. If this is the first time the projector has been powered up with the lens, expect a short period (about 15 seconds) where the lens moves slightly.

Selecting a source

1. To select and display the image for the connected source, press one of the input keys on the remote, or on the built-in keypad.

Aligning the image

Only perform image alignment once the projector is fully assembled and powered up in its final location. Basic image alignment ensures the image reflected from the DMDs is parallel and well-centered with the lens and screen. This initial optical alignment is the foundation for optimizing images on the screen and must be completed before final boresight adjustments. Before beginning, make sure the projector is properly positioned in relation to the screen.

1. To display a test pattern press **Test** on the remote keypad or use the built-in keypad and press the soft key that displays Test on the LCD display.
2. Select a pattern appropriate for analyzing image focus and geometry, such as the Grid test pattern showing the cross-hair centered across the image.
3. Do a quick preliminary focus and (if available) zoom adjustment with the primary lens.

Do not worry about consistency across the image at this point, just center focus. It is good practice to have zoom adjustment color and focus adjustment color in the center of its range.

4. Holding a piece of paper at the lens surface, adjust offsets as necessary until the image is centered within the lens perimeter. A full white field works best for this.
5. If the projector is mounted off center to the screen axis, offset the lens as much as required. Aim the projector over slightly towards the center of the screen, but use caution when doing so, as too much tilt will cause excessive keystone distortion.
6. With the framing pattern on screen, double-check projector leveling so the top edge of the image is parallel to the top edge of the screen.
7. Ensure the projector is positioned in the throw distance range for the particular lens.

Folded optics

In rear screen applications where space behind the projector is limited, a mirror may be used to fold the optical path. The position of the projector and mirror must be accurately set. If considering this type of installation call your dealer for assistance.

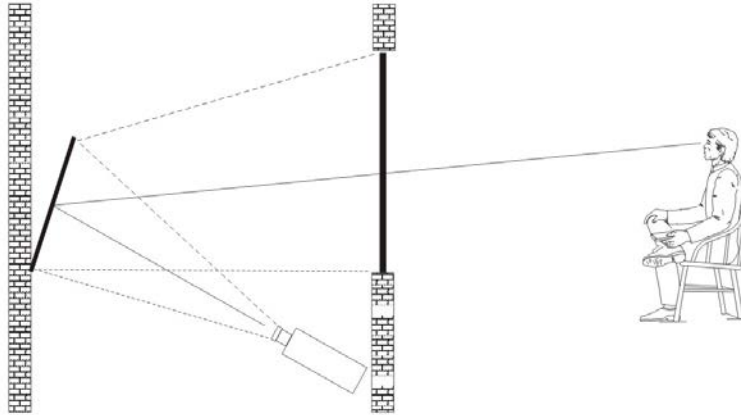

Aligning boresight

1. Display the boresight test pattern.
 - a. Pressing **Test** on the remote keypad or use the built-in keypad and press the soft key that displays Test on the LCD display.
 - b. Press the **Up Arrow** key to cycle to Boresight.
 - c. Press **Enter**.

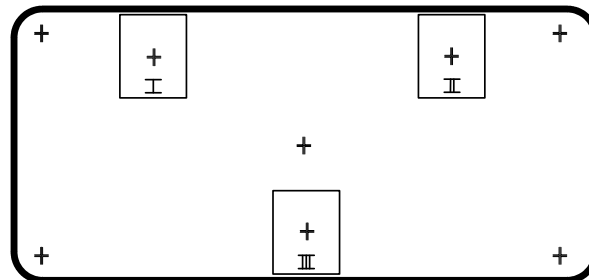

2. Focus the image on cross-hair image **I**.
3. Evaluate the focus on cross-hair image **II** and **III**.

If all three images are in focus, no further action is required.

If boresight is required, continue to step 3.

The adjustment screws on the lens mount affect the corresponding cross-hairs on the test pattern. The cap screw (B) may be under a plastic cap. Remove and retain before adjusting.

- Use a 5 mm hex driver to loosen three setscrews (A) on the lens mount. The setscrews must be backed out several turns to avoid contact with the inner lens mount plate.

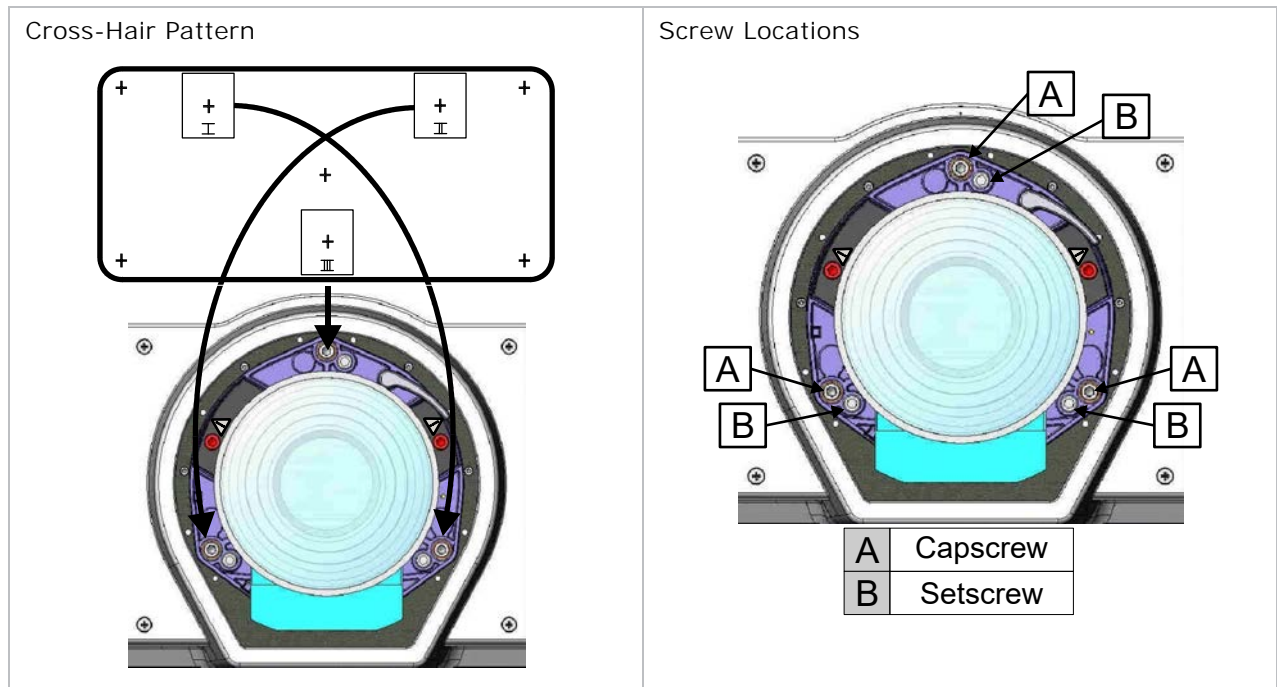

- Fine tune the focus of cross-hair pattern I by adjusting the appropriate cap screw. Adjust until the cross-hair image is in focus with minimal flare.
- Adjust cross-hair pattern **II**, by adjusting the appropriate cap screw. Adjust until the cross-hair image is in focus with minimal flare.
- Adjust cross-hair pattern **III**, by adjusting the appropriate cap screw. Adjust until the cross-hair image is in focus with minimal flare.
- Repeat step 5, 6, and 7 as required until all three cross-hair patterns are in equal sharp focus. If the boresight is acceptable, proceed with step 11.

If the boresight does not appear to be converging to an acceptable level of image quality, or if the lens will not focus over the correct range of throw distances, proceed with step 9.

9. The original factory boresight can be approximately recovered, by positioning the three setscrews flush with the front face of the lens mount plate, and in contact with the inner lens mount plate. This may require adjusting both setscrews and cap screws.

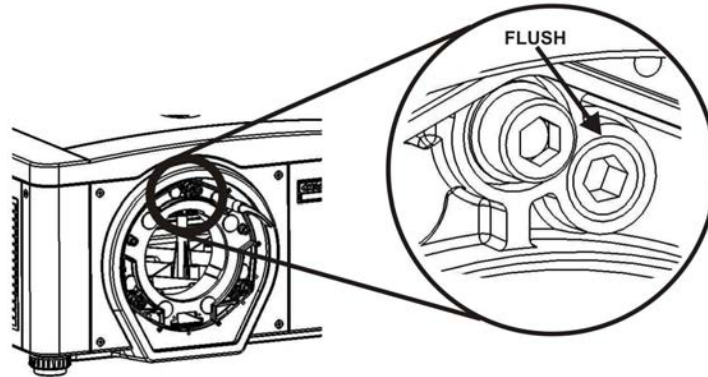

10. If further action is required. Repeat step 2.
11. Lock the setscrews, and re-check the boresight quality. Tighten the setscrews enough to ensure they do not shift.

Powering down the projector

The projector can be powered down by using one of the following methods:

Remote keypad/built-in keypad

- Press and hold **Power**.
or
- Press **Power** twice.
or
- Press **Power** once, then immediately press the **Down** key.

If the second key is not pressed immediately, a confirmation window appears. The second key must be pressed within one second of the window appearing.

After powering down, the Status LEDs cycle, and the LCD displays the message *Cooling Down* until cool down is complete.

Web user interface (UI)

1. From the **Main** tab, select **Power** > **OFF**.
2. Select **Yes**.

Connect communications

Configuring Ethernet settings

This menu should only be accessed by administrators. In **Configuration > Communications > Ethernet Settings**, configure the following:

- **DHCP**—Users may enable **Dynamic IP** (DHCP) support if the network is equipped with a DHCP server. Once enabled, the projector configures the IP address, subnet mask, and default gateway with the settings provided by the DHCP server. When disabled, the projector resets the address back to the default static address (0.0.0.0). If the projector cannot contact a DHCP server, the projector software reverts to using the Link-Local IP settings.
- **Link-Local IP**—When set to **Dynamic IP**, the projector configures itself to a valid IP address, even if no DHCP server is available to provide a dynamic IP. If the PC is configured to obtain an IP address automatically (by default in Windows), both the PC and the projector uses compatible IP addresses.
- **IP Address**—If DHCP is disabled, enter a valid and unique IP address for use on the network to which the projector is currently connected. This address overwrites any previous IP address such as the projector's factory-defined default. It takes approximately 10 seconds for the projector to respond at its new address.
- **TCP Port**—On some Ethernet networks, firewall restrictions may require that the port number of the projector be changed from its default of 3002. If so, enter a new valid port number here. Christie highly recommends not using a port number below 1000, as these ports are typically reserved for and used by common IP applications.
- **Subnet Mask**—Determines the subnet for the IP address and must be set manually, if not using DHCP.
- **Default Gateway**—The IP address of the gateway used to reach any non-local IP addresses. All PCs and projectors must be on the same subnet and it must be set manually, if not using DHCP.
- **Host Name**—Set the host name for the device.
- **Domain Name**—Set the domain for the device.
- **Mac Address**—Displays the MAC address of the projector (read-only).

Serial port connections

RS232 and RS422 serial ports are both available on the projector: You can connect a device with a serial interface, such as a computer to either of these connectors (not both) and control the projector remotely by entering specific serial communication commands. See [Tiling an image over multiple screens](#) on page 69 and the [M Series Serial API Commands Technical Reference](#) (020-100224-XX).

Connecting through RS232

Two nine-pin D-sub connectors, labeled RS232 IN and RS232 OUT on the input panel, are dedicated to serial communication.

1. Using the appropriate serial communication cables, connect the controlling source, such as a personal computer to the RS232 IN connector.
2. Set the projector baud rate to match that of the computer. See [Specifying serial communication parameters](#) on page 51 for details on changing the baud rate.

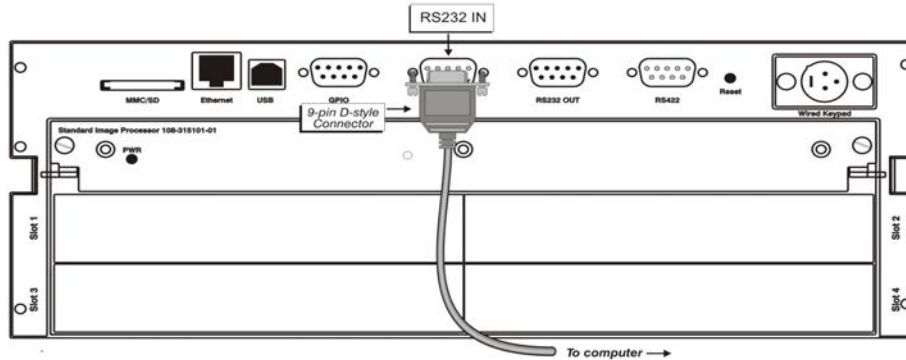

Connecting through RS422

To control the projector with a computer or other controlling device with RS422 capability, connect a RS422 serial communication cable between the controlling device and the RS422 port on the projector. RS422 is better suited than RS232 for serial communication over distances greater than fifty feet.

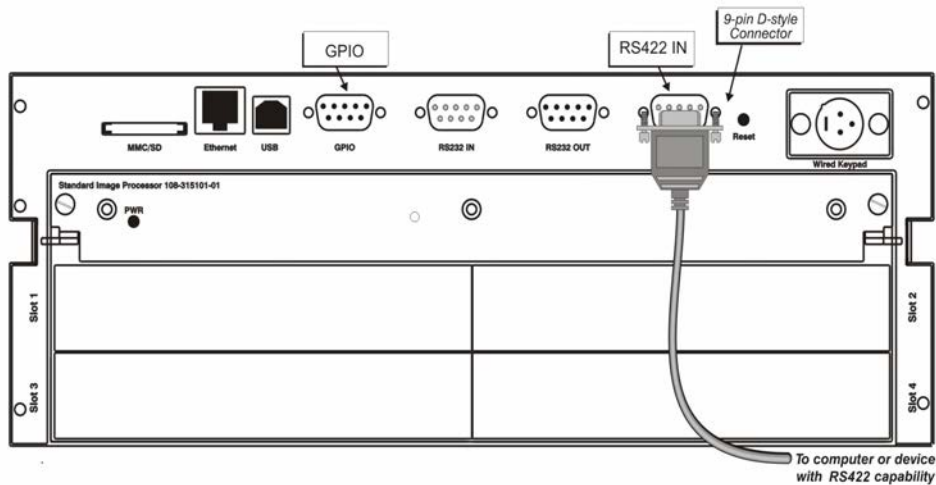

RS422 pins		
Pin #	Signal	Direction
Pin 1	DNC	N/A
Pin 2	RXD-	IN
Pin 3	TXD-	OUT
Pin 4	RXD+	IN
Pin 5	TXD+	OUT
Pin 6	DNC	N/A
Pin 7	GND	N/A
Pin 8	NC	N/A
Pin 9	+12V(500mA)	OUT
* DNC are do-not-connect pins.		
* NC are no-connect pins.		

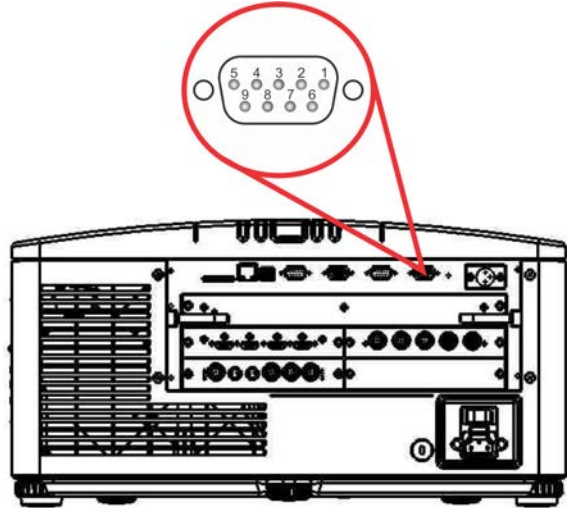

Connecting multiple projectors



Notice. Failure to comply with the following may result in property damage.

- Connect only high quality, properly wired serial communication cables.
- Each RS232 communication cable should be no more than 50 feet in length.

RS232 network

To connect multiple projectors in a network with serial communication, complete the following steps:

1. Connect the controller source to the RS232 IN connector of the first projector in the network.
2. Use another serial communication cable to connect one end to the RS232 OUT connector and the other end to the RS232 IN connector of the next projector.

- Continue this pattern of connection with all projectors in the network.
The last projector in the network only has a connection to the RS232 IN connector.

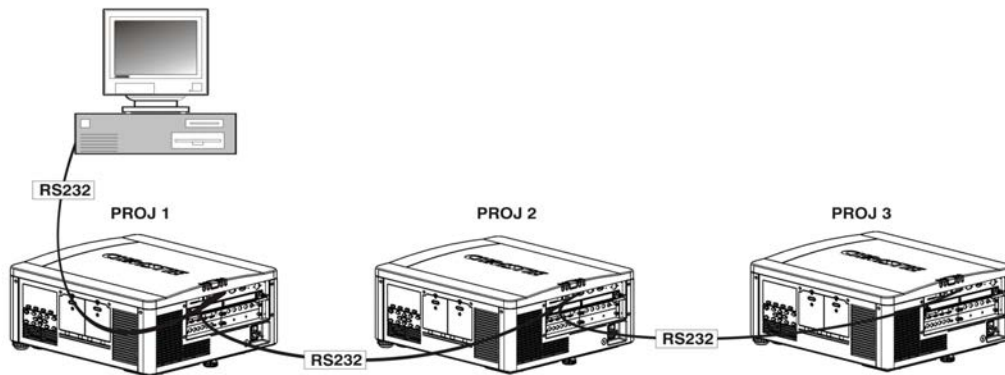

Mixed network

Communication parameters, such as baud rate, must be set to match the particular controller device, before connecting as a network. See the documentation that came with your controller device to determine the proper baud rate. See [Specifying serial communication parameters](#) on page 51 for help changing the projector baud rate. To communicate to all projectors, set the Network Routing to **RS232 and RS422 Joined**.

To control multiple projectors with a computer/controller having an RS422 interface:

- Set them all to the same baud rate as your RS422 controller.
NOTE: You must enable this combination of RS422 and RS232 in the **Communications** menu. Set the **Network Routing** option to **RS232 and RS422 Joined**, see [Specifying serial communication parameters](#) on page 51.
- Chain the projectors together by connecting an RS232 OUT (Null Cable) of the first projector (already connected to the computer/controller) through the RS422 port straight thru to an RS232 IN on the next projector in the chain. Continue connecting projectors in this manner until the last projector in the chain, so that only the last projector has one unused port RS232 OUT.

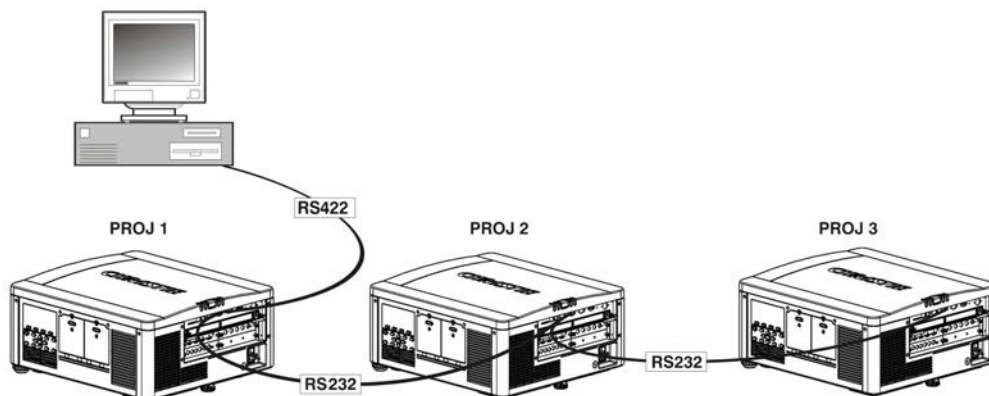

Ethernet network setup

To add one or more projectors to an Ethernet network, use standard CAT5 cables to connect each projector Ethernet port to a hub on the network. A controller or PC must also be connected to the hub. A wireless router can be used to communicate to the projectors over 802.11b/g.

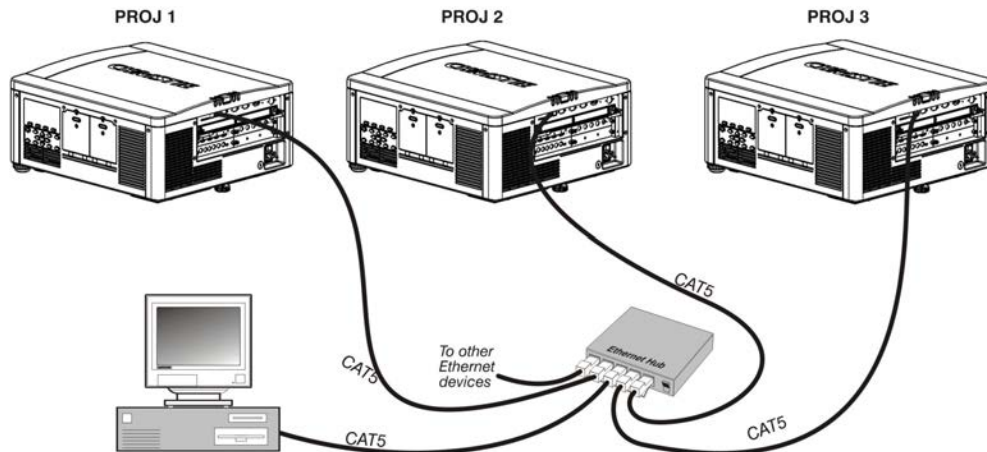

Setting the projector IP address, subnet mask, and gateway

See *Configuring the lens* on page 67.

Changing the port number:

On some Ethernet networks, firewall restrictions may require that the port number of the projector be changed from the default of 3002. If so, enter a new port number in the **Ethernet Settings** menu or include the new port number.

Separate networks

By default, communications which originate from one type of serial controller—RS232 vs. RS422 vs. Ethernet—stay on the corresponding network path. A separate setting indicates this separation for **Network Routing**, see *Tiling an image over multiple screens* on page 69. For example, if using an RS422 controller it communicates only with the projector to which it is connected unless you change this setting to either **RS232 and RS422 Joined** or **All Joined**.

Communicating to all ports

To relay all messages to all ports—RS232, RS422, and Ethernet—set the **Network Routing** option for each projector to **All Joined**, see *Specifying serial communication parameters* on page 51. This configuration is useful if using a non-RS232 controller with the RS232 linking available between these projectors. For example, you may want to use both an RS422 compatible controller and an

Ethernet connected PC for working with a network of projectors linked through their RS232 IN/OUT ports.

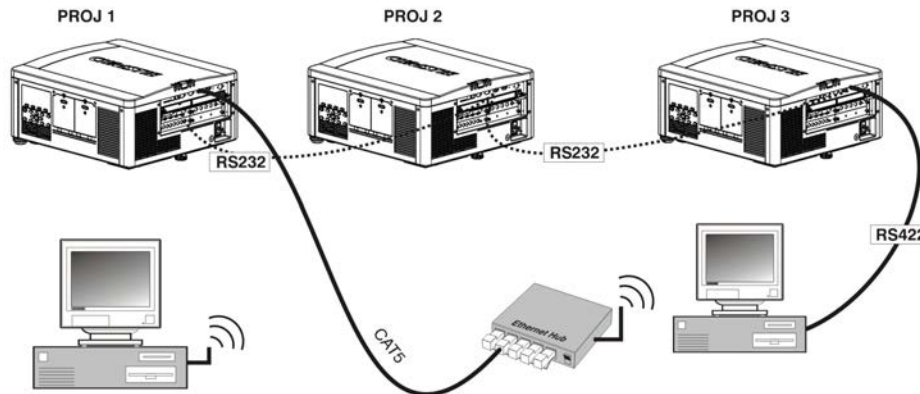

To isolate just RS422 communications, select **RS232 and Ethernet Joined**. Only projector 1 responds to the RS422 controller.

To isolate just Ethernet communications, select **RS232 and RS422 Joined**. Only projector 1 responds over Ethernet.

Connecting to the GPIO connector

The GPIO connector located on the input panel provides a flexible method of interfacing a wide range of external I/O devices to the projector. Seven GPIO pins are available on the 9 pin D-Sub GPIO connector, which are configurable with RS232 commands. The other two pins are reserved for ground and power—see the table below for pin identification.

The serial cable required for connecting the external device to the projector’s GPIO connector must be compatible with the external device.

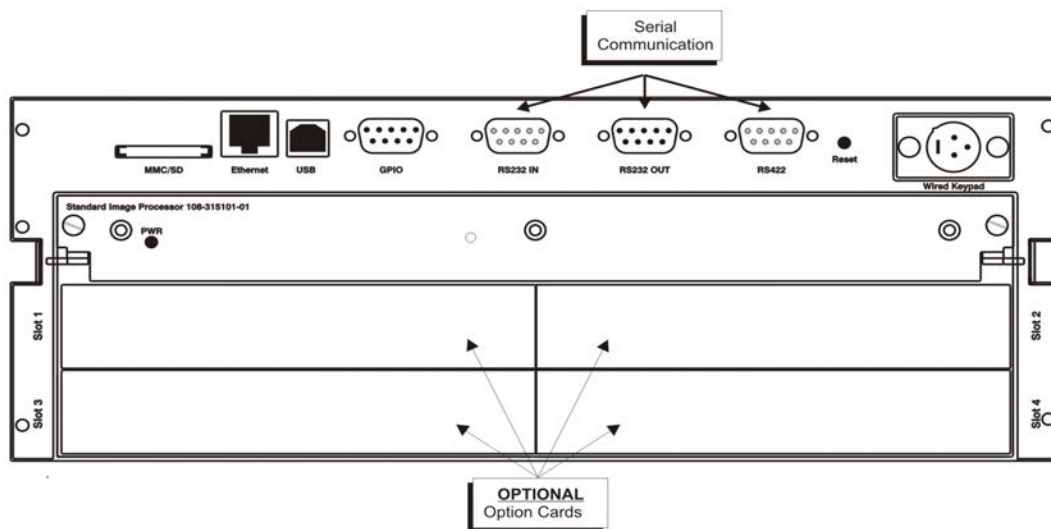

GPIO pins	
Pin #	Signal
Pin 1	+ 12V (200mA)
Pin 2	GPIO 2
Pin 3	GPIO 4
Pin 4	GPIO 6
Pin 5	Ground
Pin 6	GPIO 1
Pin 7	GPIO 3
Pin 8	GPIO 5
Pin 9	GPIO 7

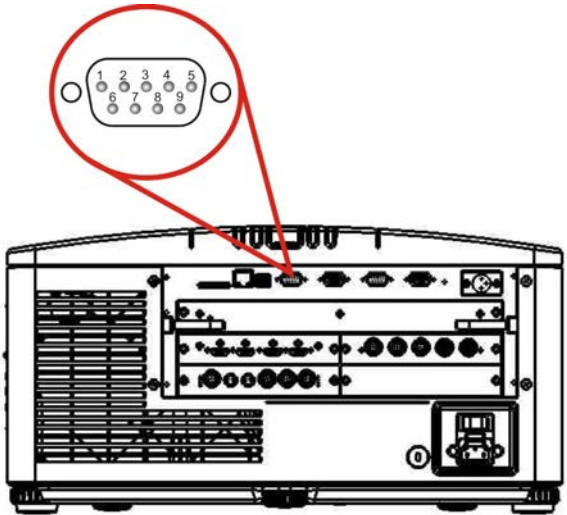

Configuring the GPIO

The GPIO connector can be configured to automate any number of events using the serial command code **GIO**. Each Pin is defined as either an **input** or **output** depending on the required outcome. Configure the pin as an input if you want the projector to respond to something the device does and as an output if you want the external device to respond to an action taken by the projector. For example, configure the pin as an output if you want the lighting in a room to automatically dim when the projector is turned on.

By using the GIO command, you can also set the state of each output pin as **high** or **low**. By default, the state of each pin is **high**. The voltage applied to pins in the high state is +3.3 V.

A low state (or value of 0) is read on an input pin if the circuit attached to the pin is open. A high state (or value of 1) is read on an input pin if the circuit attached to the pin is shorted to ground. This corresponds to a switch closing event.

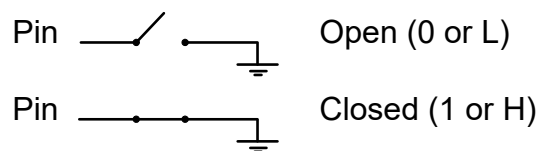

Example: Turn room lighting on when the projector is turned off (assumes a control/automation unit is configured to turn the lights on when pin 2 of its input goes high).

(GIO+CNFG "OOOIII")	Set pin #2, 3, and 4 configuration to output and pin 6, 7, 8, and 9 to input
(GIO+STAT "HLXXXX")	Set pin #2 to high, pin 3 to low and the state of all other pins unchanged
(GIO+STAT)	Request the state of all pins
(GIO+STAT "HLLHLLH")	Reply of pin states—H means pin is high, L means pin is low
(GIO+CNFG)	Request the configuration of all pins
(GIO+CNFG "IIIOOOO")	Reply of pin configurations—pins 2, 3, and 4 are Inputs, pins 6, 7, 8 and 9 are Outputs

The strings in the commands refer to pins 2, 3, 4, 6, 7, 8, and 9 in order from left to right.

Connecting sources through option cards

Sources are connected to the input panel located at the back of the projector. The Input Panel allows one image processor board and up to four input cards to be inserted. The input cards are hot swappable, meaning they may be plugged in and out while the projector is active. The image processor should only be replaced when the projector is off or when it is in standby mode.

Seven option input cards are available:

- High-Definition Multimedia Interface/Twin HDMI (High-Definition Multimedia interface)
- Analog BNC
- Dual 3G/HD/SD-SDI (Serial Digital interface)
- Dual Link DVI
- Video Decoder
- DMX512 interface
- Twin Display Port

These cards slide into the option slots located at the rear of the projector and can be used in any slot. One or more of the option slots may be used with any combination of option cards, including multiples of the same card type. There may be up to two active inputs displayed at any time, either from one card or from two cards. These two inputs can be routed to outputs or to the main or PIP video image.

LEDs

LEDs are located on the faceplate of each input card and indicate the following:

- Power ON —Green
- Signal Valid—Green
- Signal Invalid—OFF

Twin HDMI input card

This card accepts one or two HDMI inputs and can route one or both inputs to the card's outputs. Any input from any card can be looped out of this card. The output label **1-OUT** loops out the main image being displayed on the projector. The output labelled **2-OUT** loops out the image displayed in the picture in picture (PIP). Any input from any optional input card can be looped out of this card. There are five LEDs on the module faceplate. The PWR on the left side indicates power is applied and the card is initialized. The LEDs to the right side of the corresponding connectors indicate that a valid signal is detected. In the case of the output, the LED indicates a signal is currently being looped out.

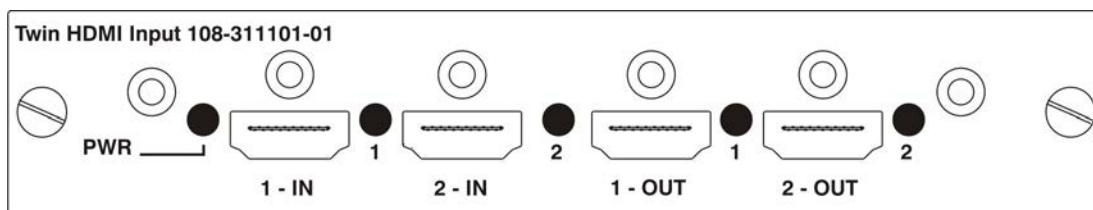

Analog BNC input card

This card accepts several types of sync modes. In five-wire sync mode all five BNC connectors are used. If H and V connectors are swapped, this card operate normally. An analog graphic source such as a VGA from a PC can be connected. The card can operate in four-wire sync mode, which accommodates four-wire RGBC sources. The composite sync cable can be connected to either the H/C BNC or the V BNC. The card supports three-wire RGB or YPbPr sync modes, sometimes called sync-on-Green (SOG). In this mode the H/C and V connectors are not used. The sync is connected to the Green/Y BNC connector. This card offers no loop out capability. Two LEDs are on the module faceplate. PWR indicates power has been applied and the card is initialized, signal indicates a valid signal has been detected.

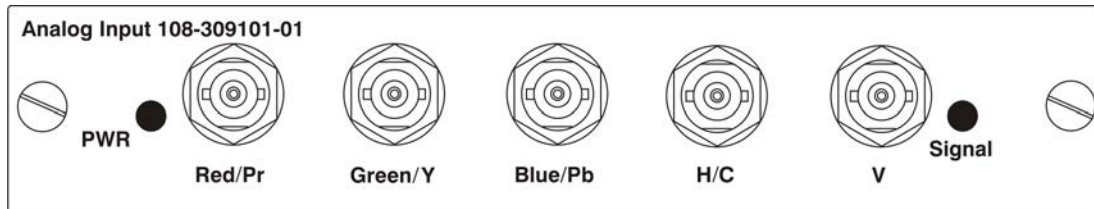

Dual 3G/HD/SD-SDI input card

This card accepts both standard-definition (SD) and high-definition (HD) serial-digital-interface (SDI) signals from one of two SD or HD 3GHz SDI sources. Both single-link HD and dual-link HD signals are accepted. The card has two SD/HD-SDI outputs, each of which is **loop through** for its respective input. Three LEDs are on the module faceplate. PWR indicates power has been applied and the card is initialized, and the two signal LEDs indicate a valid signal has been detected on the respective input.

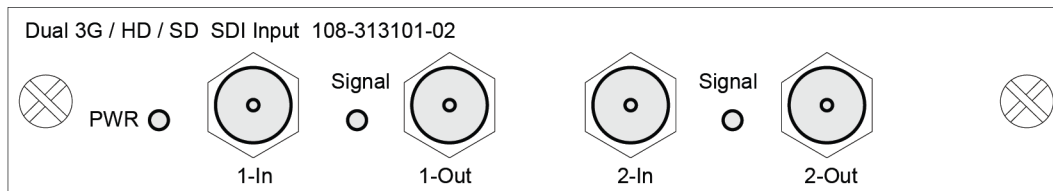

Dual link DVI input card

This card accepts a single DVI signal with or without High-Bandwidth Digital Content Protection (HDCP) video signal over a DVI-I connector and analog video signals over the DVI-I or fifteen-pin VGA connector. The module can simultaneously support a digital signal on the DVI input and an analog signal on the VGA port; however, it does not support two analog signals at the same time. Four LEDs are on the module faceplate. PWR indicates power is applied and the card is initialized, and the other three on the right side of the corresponding connectors indicate a valid signal has been detected.

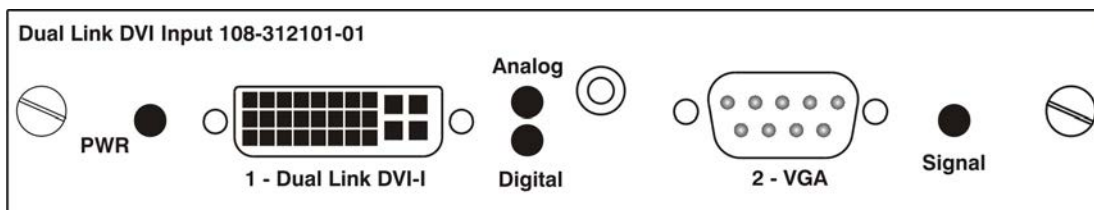

Video decoder input card

This card accepts and decodes standard definition (SD) video, including CVBS (composite video), S-Video, and component sources. This card supports as many as six video signals, four of them on BNC connectors and two on four-pin mini-DIN connectors. Each mini-DIN connector accepts one S-Video signal. The first BNC accepts composite video (only), while the remaining three BNC's can be grouped to allow one of the following combinations:

- three CVBS sources on 4, 5 and 6
- one CVBS source, one S-Video source: Luma (Y) connected to 4(Sy) and Chroma (C) connected to 6 (Sc)
- one YPbPr source: component signal on 4 (Pr), 5 (Y) and 6 (Pb)

The video decoder input card has eight LED indicators. The PWR LED indicates that the module is installed properly, and has been successfully configured. The YPbPr LED indicates a valid component signal has been detected on inputs 4, 5, and 6. Component input grouping must also be selected in the projector menu. The remaining LEDs are each associated with one of the inputs and indicate a valid signal has been detected on that input.

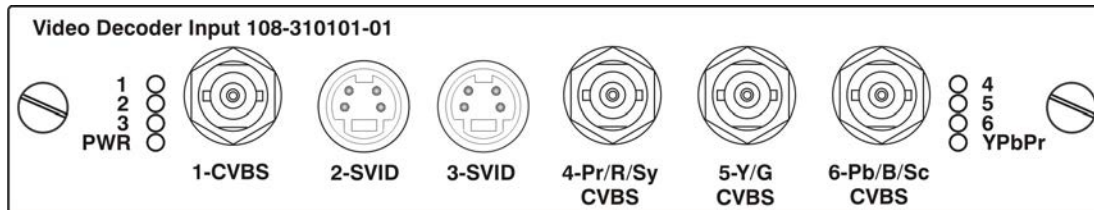

DMXC interface card

The DMXC card is a communication interface which allows the projector to be controlled using the standard E1.11 USITT DMX512-A protocol (DMX512-A 2008). DMX-512 is a serial protocol which is used for controlling lighting and staging equipment from a lighting console or similar host device. ArtNET (defined by Artistic License's Art-Net II Specification) is an Ethernet implementation of the DMX protocol. The Mirage M Series projector supports the DMX protocol through two data input interfaces, a DMX card and ArtNET through the Ethernet connector.

The DMXC card is not an input interface for video signals, but it plugs into a standard input card option slot. The card can always be active, even when the projector is in standby mode. Only one DMXC card is allowed per system. If more than one card is installed, only the first card is activated.

The card has two five-pin XLR connectors—one (input) male and one (output) female. Two LEDs are on the faceplate of the card: the green power LED which is on when the card is powered and the green termination LED which is on when termination is enabled.

Input termination (2 Watt, 120 Ohm) is required on the last DMXC card in a loop through configuration (such as only on the last projector). Termination may be either hardware (by plugging in a termination dangle, for example) or may be switched by software but should not be both. Software termination is only in place when the projector has AC applied. If there are cases where the network is required to be terminated without AC applied to the last projector, a hardware terminator should be used.

For information about setting up the ArtNET and DMX interfaces, see [Configuring DMX512 support on page 52](#).

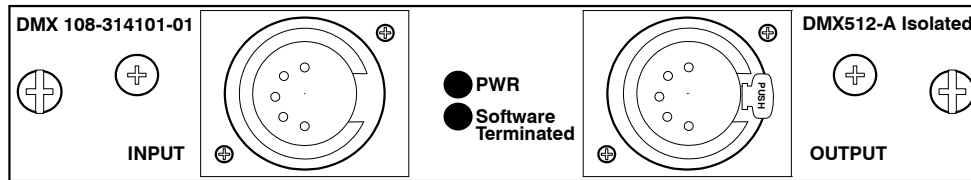

Twin DisplayPort input card

The Twin Display Input card accepts DisplayPort 1.1a inputs from one or two DisplayPort sources. The card has two DisplayPort outputs, each of which is *loop through* for its respective input (loop through of encrypted content is not supported). Five LEDs are on the card faceplate. The PWR on the left side indicates power is applied and the card is initialized. The LEDs on the right side of the corresponding connectors indicate a valid signal is detected. In the case of the output, the LED indicates a signal is currently being looped out.

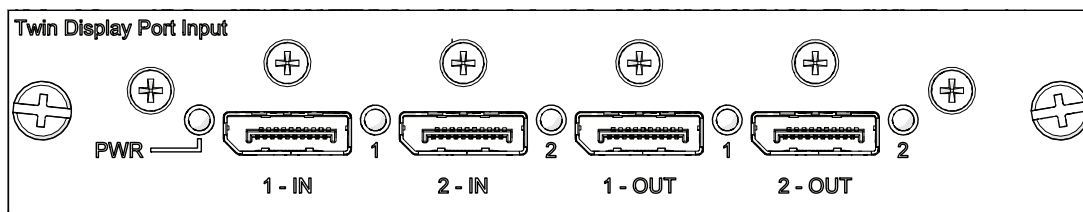

Configuring the output options cards

In **Configuration > Output Options**, configure the following:

- **Screen Image Orientation**—Selects the on-screen image orientation from Front, Rear, Front Inverted, and Rear Inverted.
- **Frame Locking**—Selects how the projector controls the output frame timing based on the input signal.
 - **Framelock** output image frames are locked to the input if possible.
 - **Locked** output is always locked to the primary input, never the PIP/Secondary image.
 - **Free Run** sets the output to close to 60Hz for all sources. When switching to a new input with frame locking enabled, the image appears black for a short duration while the system locks onto the new input.
- **Set Frame Delay**—Delays the output signal timing relative to the input signal timing by a fraction of a frame, and up to several frames. The minimum latency can vary based on the amount of scaling applied to the image. When using keystone or warping, an additional latency is required, depending on the amount of warp. This is only available when the input signal is frame locked. In Free Run mode, or in cases where the signal cannot be frame locked, the minimum latency defined by the scaling and keystone/warp is applied to the signal.
- **Actual Frame Delay**—Dynamically calculated by the software with the achievable range being smaller than the set range. The image parameters include, image shift, scaling, warp/keystone applied and format. The menu displays both the user selected value and the actual frame delay

value. When setting up tiling of projectors, all projectors in the tile should be set to the worst case, which is the projector with the highest minimum for the setup.

- **Free Run Frequency**—Sets the output video vertical frequency.
- **Fade To Black Time**—Sets the amount of time (in seconds) it takes to fade the image to and from black. The on-screen display only allows the fade time to be set. To initiate a Fade to Black, the Christie Serial command should be used.
- **HDMI Output Loop Source**—Configures the HDMI output options. Selecting **Direct Loop** directly passes the HDMI input signals: on the same Twin HDMI Input Card, the Input1 signal is looped to Output1 and the Input2 signal is looped to Output2. Selecting **Main/PIP Loop** loops the Main and PIP video to the outputs, regardless from which card these signals originate. The Main video signal is looped to Output1 and the PIP video signal is looped to Output2. Selecting **Disable** turns off the HDMI outputs completely.

PIP functionality is disabled in 3D mode.

Connecting tiled projectors

Wiring requirements

A distribution box or digital signal switcher may be used to feed the same video signal to all the units of the tiling array.

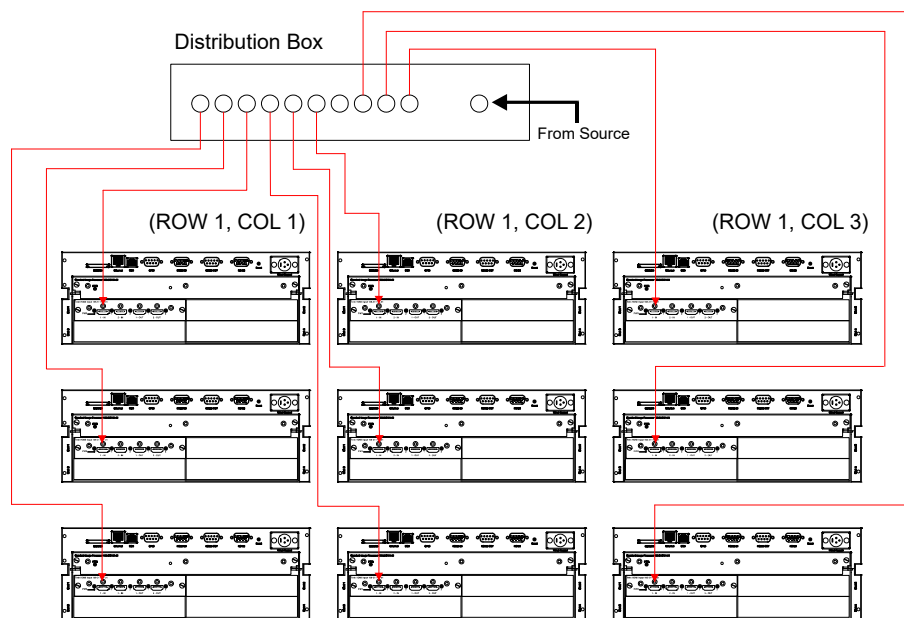

FIGURE 1-1 USE OF DISTRIBUTION BOX

Christie loop-through may be used to set up a tiling array. The system allows wiring (providing the HDCP requirement is met) when HDCP is used by the source. The cascade level of devices must be no more than seven levels deep. If single wire loop-through is used, then PIP is not supported.

The wiring diagrams are provided to:

- Meet the HDCP requirement.

- Minimize the length of HDMI cables to be used.
- Balance the connection tree to ensure the level of loop-through is minimized.

This enables the downstream projectors to finish source switches in a minimum amount of time. (Applicable to arrays with HDCP only)

1x3 wiring solution

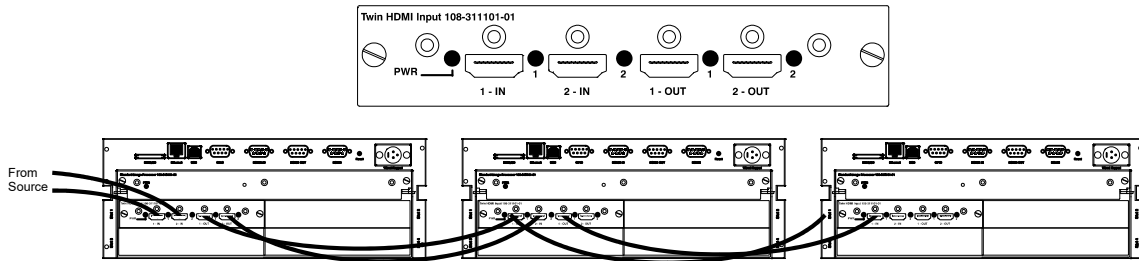

2x2 wiring solution

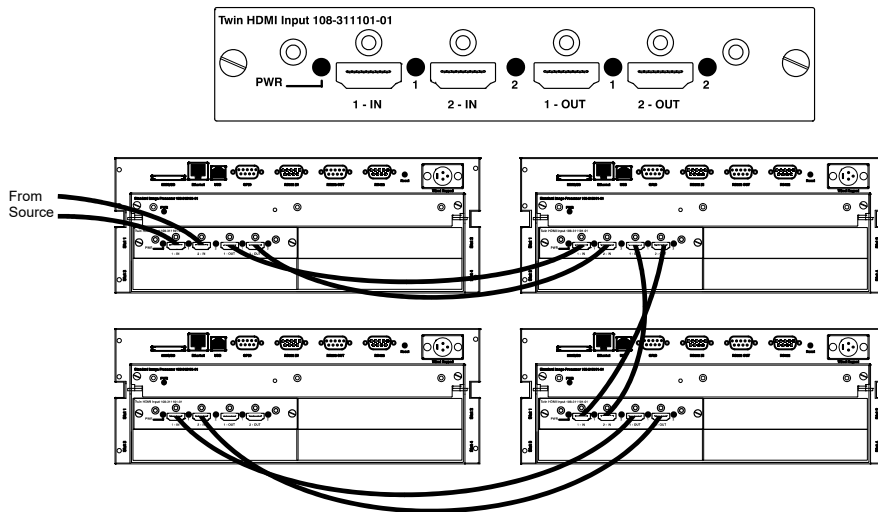

2x3 Loop-through wiring solution

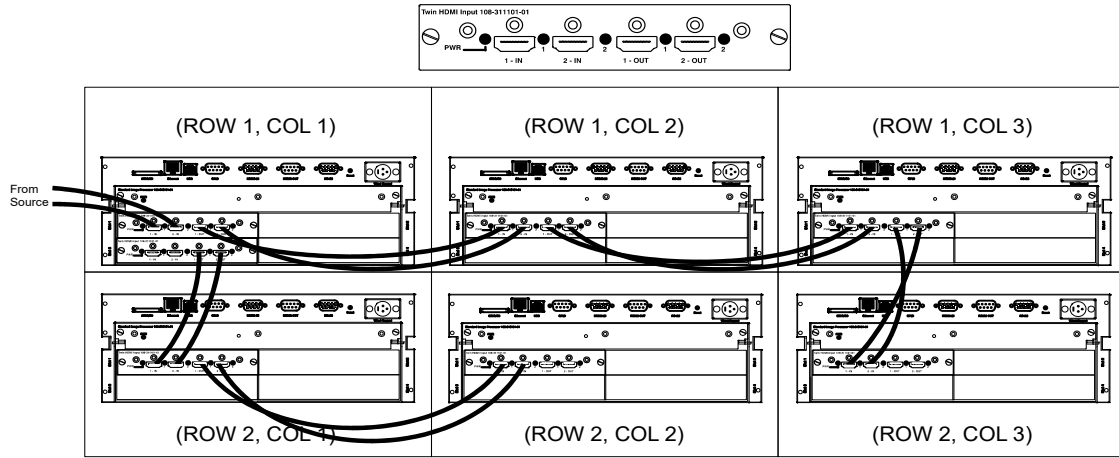

2x3 Single wiring loop-through—no pip supported

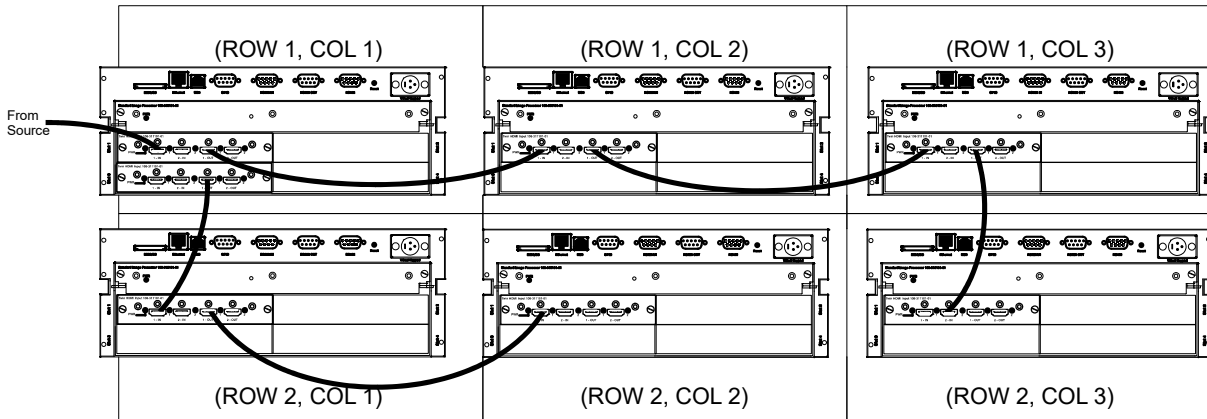

3x3 Loop-through wiring solution

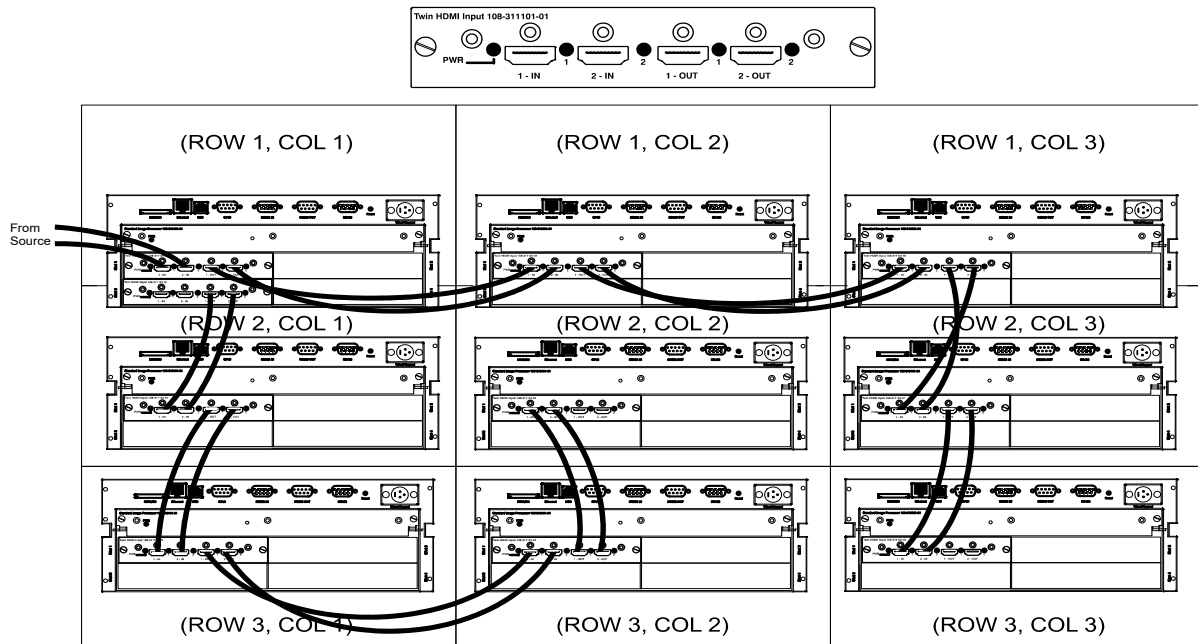

Defining the communication method between projectors

In **Configuration > Communication** define and control how single or multiple projectors are linked with each other and with a controlling device. For serial commands see the *M Series Serial Commands Technical Reference* (P/N 020-100224-XX).

Specifying serial communication parameters

In **Configuration > Communication > Serial Options**, configure the following:

- **Baud Rate**—Determines the speed of communication to and from the projector on the RS232 or RS422 links. The maximum rate for the RS232 is 115200; for RS422 it is 19200. Serial communication is always eight data bits, no parity.

Set the baud rate to match that of your controlling device, such as your PC. Refer to the documentation for the controlling device to determine the baud rate.

In an existing network of projectors, if you discover a projector has a different baud rate, use the pull-down list and select the correct baud rate using the **Enter** key. Do not scroll this control with left or right arrow key.

- **Serial Flow Control**—Determines whether software flow control or no flow control is used when transmitting and receiving data on the serial port.
- **Projector Address**—Assign a three-digit number (such as 001) or change a number to the projector currently in use. If the current projector already has a number assigned, that number appears. Numerical identity for projectors enables you to communicate with a single projector

within a multiple-projector application (see also **Proj** key in *Wired remote* on page 56). If you make a mistake in assigning or changing the projector number, press **Exit** to cancel.

When multiple projectors are being used and you want to adjust the color for individual projectors to create one seamless image, you must assign different numbers for each projector to allow switching back and forth between projectors while adjustments are being made.

- **Network Routing**—This is not applicable for stand-alone projectors or simple serial networks with only one type of controller and linking.
 - **Separate**—Keep RS232, RS422 and Ethernet messages on their respective paths instead of being broadcast to the other types of ports.
 - **RS232 and RS422 Joined**—Messages originating from an RS232 or RS422 controller are relayed to all RS232 or RS422 ports; any Ethernet communication, however, is not.
 - **RS232 and Ethernet Joined**—Messages to and from the RS232 ports are relayed to the Ethernet port, and vice versa. Any RS422 communications are isolated. In the case of multiple Ethernet sessions over the single Ethernet connector, input on the RS232 port is relayed to all Ethernet sessions; however, input from any Ethernet session is only relayed to the RS232 ports.
 - **All Joined**—All messages reach all ports, regardless of type in the case of multiple Ethernet sessions, input on one Ethernet session is relayed to all other Ethernet sessions as well as to the RS232 and RS422 ports.

Adding a serial command

For serial commands see the *M Series Serial Commands Technical Reference* (P/N: 020-100224-XX).

1. Click **Advanced > Serial**.
2. Enter a serial command in the Serial Command field.
3. To add the serial command, click **Send**.

Configuring DMX512 support

The projector supports the DMX512 protocol through the DMXC option card and through the ArtNET communications with an the Ethernet connector, as configured in **Configuration > Communications > DMX/ArtNET**. For the DMX Channel Allocation, see *Appendix: DMX/ArtNET* on page 133.

Both input methods share the same feature list and can share the same configuration methods as follows:

- The user may select to monitor both, neither, or a single interface through a DMX control.
- If both interfaces are selected, the DMXC input card takes priority if it is actively receiving data. While data is active on this card, ArtNET packets are ignored.
- Only one DMXC card can be used at a time. If more than one is populated, the second and subsequent cards are not activated.
- The DMXC card is always active, even when the projector is powered down or in standby mode.

When controlling a projector with DMX,

- No other interfaces (such as the IR Remote or Web UI) are used.
- The menu for setting the ArtNET and DMX interface is always available at: **Configuration > Communications > DMX/ArtNET Settings**.

When a DMXC card is installed, the same menu is available at: **Configuration > Option Card Settings > DMX Input Card > DMX/ArtNET Settings**.

- **DMX Interface**—Select whether to monitor the DMXC input card only, the ArtNET interface only, both, or neither. ArtNET is ignored if the DMXC card is actively receiving data.
- **DMX Personality**—Determines how many contiguous channels the projector responds to. Fewer channels mean more devices can be used per universe. More channels mean greater control of the projector, but fewer devices.
 - **Show Personality** (18 channels)—This is the default setting. The 18 Show channels are those controls which are expected to be used throughout the course of an actual show (such as shutter, channel change). These channels are a subset of those in the Setup Personality.
 - **Setup Personality** (38 channels)—The 38 Setup channels are those controls which are expected to be used during the setup of an actual show (such as Projector orientation, Color, Brightness, for example).
 - **Nitro Personality** (25 channels)—The Nitro personality includes channels with Load/Execute style functionality for critical functions that require security so that they cannot be changed by a single button press and are not affected by a Grand Master. This personality cannot be used with a control board containing only sliders. The Load/Execute channels operate as follows:
 - The user must load a value, then send 86 (LOAD), then send 171 (EXECUTE) to execute the loaded value.
 - If this sequence of three values is not sent to the projector, the command is ignored.
- **Base Channel**—Specifies the starting channel for this projector. There are 512 channels per universe. If multiple projectors are used on the same universe and are to be controlled independently, this value must be changed. If both projectors are using the Show personality (18 channels), projector 1 should start at base channel 1 and projector 2 should start at base channel 19.

The Base channel setting must allow enough space for the channels required by the selected personality. If the Show Personality is selected, the Base Channel may be in the range 1-494. If the Setup Personality is selected, the Base Channel may be in the range 1-474.
- **Software Termination**—Supplies a signal to the card to switch termination resistance in/out of the circuit. It may be necessary to clear this setting upon card removal. By default, software termination is disabled. The Input termination (2 Watt, 120 Ohm) is required on the last DMXC card in a loop through configuration (such as only on the last projector). Termination may be either hardware (by plugging in a termination dongle, and so on) or may be switched in by software, but should not be both.

Christie recommends hardware termination because software termination is only in place when the projector has AC applied. If there are cases where the network is required to be terminated without AC applied to the last projector, use a hardware terminator.

- **ArtNET Universe**—Specifies which universe the projector belongs to, so it can filter out all other data packets. For DMX512, each universe represents a separate electrical circuit of up to 512 devices/channels. For ArtNET however, DMX data is broadcasted over an Ethernet network, so every device receives every packet of data, whether they belong to that universe or not. This control specifies which universe the projector belongs to, so it can filter out all other data packets. The Universe applies to ArtNET only and does not apply to the DMXC input card.
- **ArtNET Subnet**—Specifies which ArtNET subnet (group of universes) the projector belongs to. This is the highest level address in an ArtNET network, providing expandability beyond the universe level. The Subnet applies to ArtNET only and does not apply to the DMXC input card.
- **Input Noise Filter**—The Input Noise Filter eliminates DMX/ArtNET input oscillation, which can occur on some DMX control boards. This can cause fine resolution controls (for example, Lens, Brightness) to continually change. A filter setting of 0 turns off the filter; a setting of 1 filters +/- 1 step changes. Using this filter decreases the fine control precision of some slider controls. By default this filter is set to 0 (Off). Christie does not recommend using this feature unless you are experiencing problems with your DMX input.
- **Host Name**—Responds to ArtNET polling queries. By default the host name is composed from the projector name and serial number. (Default = "<unit name>_<serial no>").

The hostname is also defined at **Configuration > Communications > Ethernet Settings > Host Name**.

Adding a DMX channel event

1. Click **Advanced > RTE**.
2. To open the RTE wizard, click **Add**.
3. Select the **DMX Channel Event** tab.
4. Select a **DMX** channel (DMX-56 to DMX-61).

See [Configuring DMX512 support on page 52](#) for detailed information.

Operating the projector

This section describes the controls and switches used for basic projector operation once it is properly installed, aligned and configured by a Christie accredited service technician.

Controlling the projector



Warning! Failure to comply with the following could result in death or serious injury.

- Laser radiation is emitted from the laser diode in the remote. DO NOT look directly into the beam of the laser.

The projector is typically controlled using either the remote or built-in keypad. While each of the keypads provides complete control of the projector, they differ slightly in their arrangement of keys and in what functions can be accessed directly with a key press rather than requiring use of the menu system. You may find one keypad more convenient than another for your specific installation and application.

- **Remote Keypad**—For wired or wireless control up to 25 feet (8 m) away. The remote keypad controls the projector by way of wireless communications from a battery-powered infrared (IR) transmitter. Use the remote keypad the same way you would use a remote keypad supplied with a TV or VCR. When pressing a function key, direct the keypad toward the projector's front or rear IR sensor. One of the two IR sensors on the projector detects the signal and relay the commands for internal processing. A laser pointer is built into the remote keypad.
- **Built-in Keypad**—Located at the side of the projector.

Keep these guidelines (common to both keypads) in mind:

- Press keys one-at-a-time; there are no simultaneous key combinations required. Use Power, Shutter, and on-screen display functions by doing one of the following:
 - Press-and-hold (2 seconds)
 - Press twice quickly, followed by pressing either the **Up Arrow** Key to switch on or the **Down Arrow** Key to switch off once.
- In serial networks, pause briefly between adjustments to make sure that more distant projectors can keep up with the commands. If you press a key while the projector is still responding to the previous action, such as during power-up, the second key press may not take effect.

As an alternative to using a keypad, most projector functions can be controlled remotely, typically at a controller such as a PC, through a web interface.

- **ASCII Messaging**—Connect a serial link between your controller and the RS232 or RS422 port (recommended), or open an Ethernet socket (such as Telnet) between your controller and the valid projector address. Valid ASCII codes and messages are documented in the *Christie Serial Communications* document available at the Christie website.
- **Web Interface**—Connect the PC to the projector's Ethernet port. In the web browser (such as Internet Explorer), enter the IP address of the projector you want to control. This prompts a login screen. The default login ids are: admin, service, and guest.

Up to a maximum of three users can connect at any given time. Two users can use the same account to log in. Each user sees a different set of tabs. The default passwords can be edited by an administrator or a service user in the Admin tab. Guest users do not see this tab. Basic operations of the projector can be controlled from this interface and the Virtual on-screen display can be accessed from here.

Built-in keypad

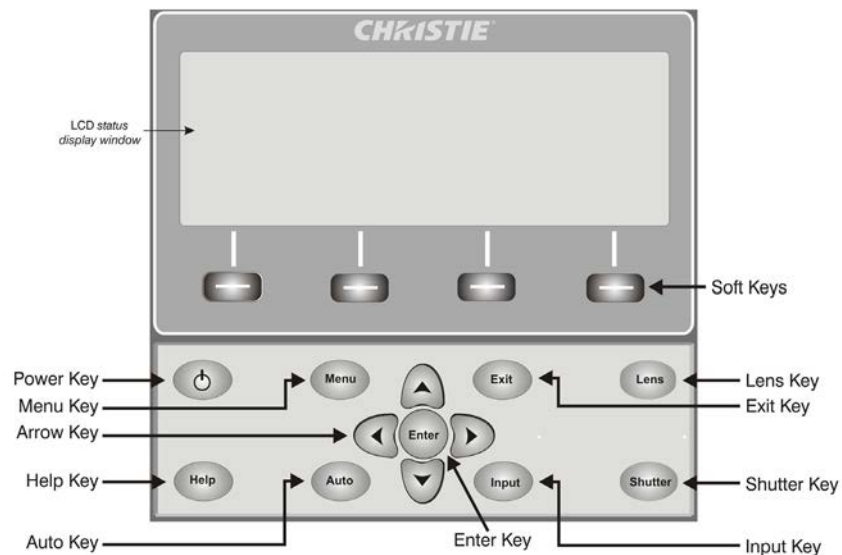

The built-in keypad has a LCD status display window which displays all states of the keypad controls. The LCD displays status information when the projector is powering up *Warm up: Lamp is warming up* and when the projector is cooling down *Cool down: Lamp is cooling down*. The display shows the state of the keys, menu structure, and menu items.

Wired remote

You can convert the remote keypad into a wired remote keypad using any standard 3-pin XLR cable (male to female). Connect one end into the remote and the other to the XLR connector on the Wired Keypad input panel. Christie recommends the wired remote when:

- The built-in keypad is inaccessible
- The lighting conditions are unsuitable for proper IR transmission

IR remote keypad

The IR remote keypad controls the projector by way of wireless communications from a battery-powered infrared (IR) transmitter. To use the IR remote, direct the keypad toward the projector's front or rear IR sensor and press a function key. One of the two IR sensors on the projector will detect the signal and relay the commands for internal processing. The remote also offers a connector for wired connections to the projector.

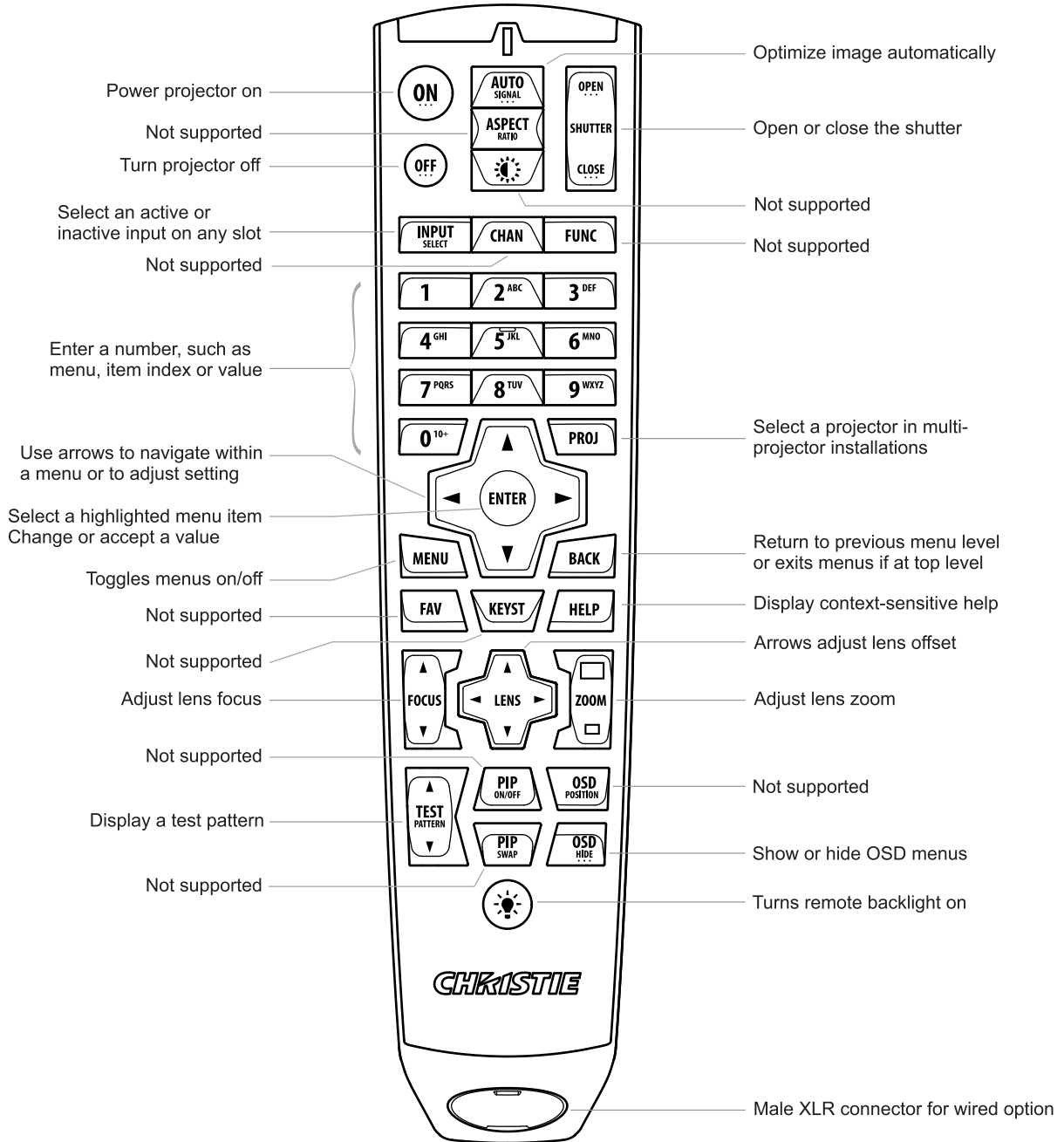

Managing users

Creating a user

Do not use capitalization for user names or passwords. If capitalization is used for the user name or password, it automatically converts it to lower case. User names can be a minimum of four and maximum of 32 characters. Passwords can be a minimum of four and maximum of 128 characters.

1. Click **Admin > Users**.
2. Click **Add User**.
3. Type your username and password.
4. Re-type your **password**.
5. Click **OK**.

Changing a password

1. Click **Admin > Users**.
2. Select the user whose password you want to change.
3. To open the Password Change window, click **Change Password**.
4. In the Password field, type the new password.
5. In the Re-type Password field., re-type the password
6. Click **OK**.

Deleting a user

1. Select the user that you want to remove.
2. Click **Delete User**.
3. In the confirmation dialog, click **Yes**.

Uploading a logo file

The projector must be powered on to enable the Upload drop-down list.

1. Click **Admin > System**.
2. To open the Choose file window, click **Upload Browse**.
3. Locate and select the file you want to upload from a network drive location or from your hard drive.
4. Select **Logo** as the file type.
The file must be a 24-bit bitmap file to enable the Logo Position and Background Color section.
5. Enter the Logo position for the **X** and **Y** fields.

6. To open the **Choose Background Color** window, click the **Color** square, choose the required background color from the color palette, and click **OK**.
The color square changes to the selected color.
7. To display the **Logo Upload** window, click **Upload**.
8. In the Display Name field, type a descriptive name.
9. To confirm the upload, click **Yes**.

Logging on

Before logging on to the system, ensure that you select the appropriate language required. Your language selection only affects the web user interface. The language used by the projector’s on-screen display is not affected.

1. Open your web browser and type the IP address (in the address bar) assigned to your projector.
2. Select the appropriate language from the Language list, located in the upper left-hand corner.
3. Type your user name and password in the User Name and Password fields respectively.
Both entries are case-sensitive.
4. To display the Main window, click **Login**.

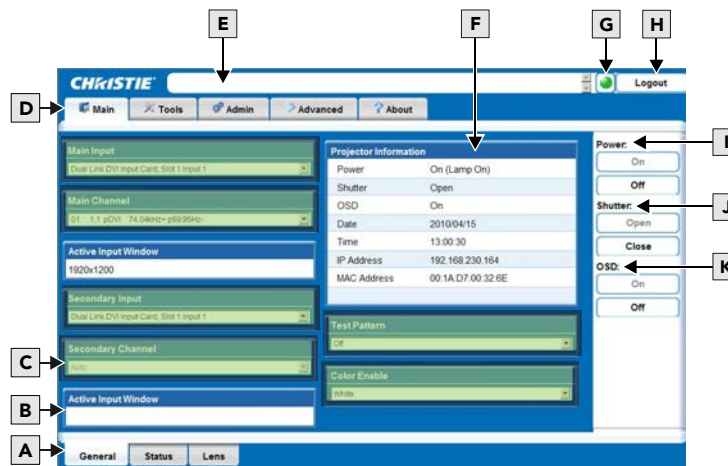

The following table describes each area found in the Main window.

A	Secondary tabs (specific to a primary tab) located along the bottom of the Main window.	G	Status Indicator displays the overall status of the projector, based on the 12 categories of information available. Click the Status Indicator LED to display the Status window and obtain more information about any current errors and warnings.
B	Active Input window section is read-only.	H	Logout button (located at the top right corner of the web browser) is used to logout you off of the web user interface and the projector.

C	These sections provide list selections.	I	Power section contains an On and Off button. Only one is enabled depending on the current powered state of the projector.
D	Primary Tabs located along the top of the Main window.	J	Shutter section contains an Open and Close button. Only one is enabled depending on the current state of the projector's shutter.
E	Current Status Bar provides information messages according to the current status of the projector.	K	On-screen display section contains an On and Off button. Only one is enabled depending on the current state of the projector's on-screen display.
F	Projector Information section is read-only.		—

Setting the power management parameters

In **Configuration > Power Management**, configure the following:

- **LCD Backlight**—The backlight for the LCD has three states. **Always On**, **Always Off**, or **Timer**. The backlight turns on again when any key on the LCD is pressed or if an alarm is raised.
- **LCD Backlight Timer**—Sets how long the LCD backlight stays on (in seconds) when in timer mode.
- **LCD Backlight Level**—Sets the LCD backlight brightness level. Maximum 25/Minimum 0.
- **Auto Power Up**—If there is an AC power interruption, while Auto Power Up is enabled, the projector resumes operation in the same state as it left off. If the lamps are on and an image showing when AC power is lost, the projector automatically powers back up with the lamps on and an image shows when AC is restored.
- **Auto Shutdown Enable**—When Auto Shutdown Mode has been selected, and no projector activity has been seen for the activation time-out period, the projector enters a power saving mode in which the lamps dim and the shutter closes.
If this condition persists for an additional time-out period, the projector automatically goes to Standby mode. The presence of any activity within this combined interval cancels Auto Shutdown and returns the projector to normal operation.
- **Turn Off Image After (Min)**—Sets the activation interval (in minutes) for Auto Shutdown. If all activity (input signals, web or serial port activity, key presses) is lost for this length of time, and Auto Shutdown is enabled, an Auto Shutdown cycle begins.
- **Enter Standby After (Min)**—Sets the interval (in minutes) between starting Auto Shutdown and entering Standby mode. Once Auto Shutdown has been entered, and all activity continues to be absent for this interval, the projector automatically enters power Standby mode.
- **Lamp Regeneration Start Time**—Sets the time of day (in 24 hour format) when the regeneration cycle starts. For 24/7 operation, the lamp regeneration cycle is required or lamp life is reduced.

In Dual Lamp mode, the cycle is performed on each lamp separately. The second lamp waits for the first lamp to come back on before it begins the cycle. In single lamp mode, the projector goes into Standby mode for the regeneration cycle. The regeneration cycle runs for 15 minutes

for each lamp. The lamp(s) must run for a minimum of 24 hours or the regeneration cycle is skipped.

- **Over-temp Fan Assist**—When enabled, this option causes all fans to come on at full speed if any enabled thermal sensor has an over-temperature fault. This may help to prevent an emergency shutdown if the extra cooling can bring the temperature within limits before the shutdown occurs. The fan assist causes increased noise levels due to the simultaneous full speed operation of all the fans. Normal operation resumes when all over-temperature conditions are removed or fan assist is turned off.

Setting the date and time

Configure the current year-month-day, hour-minute-second in **Configuration > Date & Time**. Changes here reset the projector real-time clock.

Navigating the interface

Most of the projector controls are accessed from within the menu system. There are several groups of related functions, with each group selectable from the **Main** menu.

On the remote keypad, enter the number that corresponds to the function menu you want to access, such as 2 for the Image Settings menu. Or use the **Up/Down Arrow Key** on any keypad to highlight the required option and press **Enter**. The corresponding function menu or list of further options appears.

With a function menu displayed, enter a menu option number for any numbered option, or use the **Up/Down Arrow Key** to highlight the required option and press **Enter**. Long menus have a scroll bar on the right; use the arrow keys to access the remainder of the menu. Locked items or items that do not pertain to the current action or condition appear dimmed and cannot be selected.

If no signal is present, all source-dependent adjustments are disabled. After 15 minutes of inactivity, the projector leaves the menu system and returns to the presentation. When finished with a function menu, do one of the following:

- Press **Exit** to return to the previous screen.
- Press **Menu** to leave the menu system and return to the presentation.

When navigating the web interface, Christie does not recommend using the web browser navigation functionality (such as the **Back** and **Forward** functions) as this causes you to lose your web connection. Christie recommends using the application interface and related functionality detailed in this section to navigate.

Changing the language used for menus

Choose the available language to use in the projector menus. The change takes effect immediately.

1. In the Configuration menu, select the language from the list.

Adjusting the menu appearance

Change the appearance, content and/or location of on-screen menus and messages in **Configuration > Menu Preferences** configure the following:

- **Large Menu Font**—Enter a check mark to enlarge menus and their text.

- **Menu Location**—Use the list to choose a pre-defined default or customized location for the display of all on-screen menus.

To create a custom menu location:

- a. Choose a preset closest to the required location.
 - b. Adjust **Horizontal Shift** and **Vertical Shift** slide bars to move the menu to the required location. Avoid locations too close to a corner or edge to prevent cropping of larger menus.
- **Display Automatic Message Boxes**—Enable or disable the pop-up of automatic message boxes. These messages to the user are not directly triggered by user actions. Examples are signal information, function limitation, or auto calibration message boxes.
 - **Display User Message Boxes**—Enable or disable the pop-up of message boxes that are directly triggered by user actions, for example gamma or lens control message boxes.
 - **Display 3D Message Boxes**—Enable or disable message boxes that are triggered by 3D setup errors.
 - **Display Error Messages**—Choose how to be notified of errors detected in either the incoming signal or projector.
 - **Screen or All** (default) to see brief on-screen messages. Christie recommends this during setup or testing of the projector.
 - **Serial Ports** to receive messages through RS232 or RS422 serial communication only.

To hide error message displays, such as during shows and presentations, select **Off** or **Serial Ports**.

- **Splash Screen Setup**—Choose when to display a special introductory splash screen image, such as your company logo, graphic or message.
 - **Always Off**—A splash screen never appears
 - **Start-up Only**—The splash screen logo appears at projector start-up only.
 - **Start-up And No Signal**—A splash screen appears at start-up and at any time when there is no signal.

To add your own splash screen in addition to the default Christie logo splash screen, use the web interface to download the required bitmap (.bmp) file to the projector. This overwrites any other user splash screen that has been downloaded. Only one user splash screen can be saved in the projector.

- **OSD Transparency**—Select this box if you want the on-screen display menu backgrounds to be transparent.
- **Menu Type**—Select the **Basic** or **Advanced** menu type.
 - The **Basic** menu setting gives a small number of the most frequently used menu items.
 - The **Advanced** menu setting gives the menu options.
- **Splash Screen**—Choose which splash screen is to be used; the default or user downloaded splash screen.

- **Cascading Menus**—Enable or disable cascading menus. When disabled, a single menu level is displayed on the on-screen display at a time.

Selecting an input or channel

The projector stores and recalls up to 99 different channels (source setups) for a variety of inputs. This memory feature allows you to define and use a variety of customized setups. Depending on what you have defined, each physical source connection (such as input at the projector) can have several different channels associated with it. For a full explanation of how to connect sources to the projector see [Connecting sources through option cards](#) on page 44.

Input: An input is a source physically connected to the projector and describes the source signal and which input slot it is connected to.

Channel: A channel is a collection of measurements, locations, and settings that tailor the display of a signal to your specific needs. Since source types and applications can vary greatly, adjust and define a wide variety of parameters such as brightness, contrast, and size to customize and optimize the display from or for a particular source. For example, the display settings you choose for a VCR source may be different from those you choose for a high-resolution computer source.

Once you have adjusted a display parameter, such as pixel tracking or contrast, all current settings are collectively stored in the projector's memory as a unique two-digit channel, such as 09. You can have numerous distinct channels available for the same input, any of which can be selected by using the **Channel** key on the keypad followed by the two-digit channel number.

The Channel key may display a channel list or not, depending on what you have defined for the Display Channel List.

There are three methods for selecting an input:

1. Press **INPUT**.

This displays a list of the four slots, with the card type and input signal type in each slot. The currently selected input for the main image is highlighted. Scroll up or down through the list and press **ENTER** to make a new selection. Press **INPUT** again to show the list and allow the selection for the PIP/Secondary image. Repeatedly pressing the **INPUT** key toggles between the main and PIP/Secondary image.

PIP functionality is disabled in 3D mode.

2. Press the appropriate direct **SLOT** key to quickly display one of the inputs on the selected slot to the main image. This does not bring up any menu selection and is only applicable for the main image.
3. To select the source of the image for the main or PIP/Secondary image select **Menu > Input Switching and PIP > Main Input** and **Menu > Input Switching and PIP > PIP Input**.

The image is displayed according to the following:

- If it is the first time you have used the source/input (or if you used the input but did not define a channel by adjusting anything), the projector recognizes the new input signal

Channel#		Slot Input	Signal Type	Horizontal Frequency	i-Interlaced p-Progressive	Vertical Frequency
Current Channel#						
Main Channel: 01						
01.	1,2	iSVid	15.73kHz-	i59.94-Hz-		
02.	4,1	pDig	33.72kHz+	p29.07-Hz+		

based on its frequencies and polarities, automatically displaying an image according to default settings for that signal.

- In general, the image from the new source is as large as possible without losing its aspect ratio. This and other default image settings depend on the incoming source.
- If you used the source once before and changed a display parameter, such as contrast and V-Position, then a channel was automatically created and still exists in projector memory. Using one of the input or slot keys automatically recall this channel, all its setup parameters, and update the display accordingly.
- If more than one channel exists for the input, the image is displayed according to the setup parameters for the first channel with matching characteristics.

Creating a new channel

To use a new source with the projector, a new channel must be created so that the projector responds to an input signal from that source. A new channel can be created automatically, or it can be copied from an existing channel and then edited as necessary.

When you select a direct input (**Slot 1**, **Slot 2**, **Slot 3**, or **Slot 4**), any existing channels in the projector are searched for matching input and signal parameters—this only occurs if Auto Source is enabled on these channels. If no match to the incoming input signal is found in currently defined channels, a new channel is temporarily created based on factory-defined defaults for this type of signal. The channel number assigned is the lowest available number from 01-99.



Notice. Failure to comply with the following may result in property damage.

- An automatic channel is discarded unless one or more of its parameters are changed and will not appear in the channel list (see below).
- If two channels have the same distinguishing source characteristics except for the reversal of sync connectors (H-sync and V-sync, are switched), they are defined as distinct channels.
- You cannot define a new channel without an incoming signal.

Selecting a channel

Select a channel at any time by pressing **Channel**. To hide a channel from appearing in this list, you must edit the channel. Such a channel can still be selected by entering its number as shown below.

The current channel is highlighted in the channel list, or if the current channel is hidden, the first channel in the list is highlighted.

Channels created automatically do not appear in the channel list unless a parameter for the channel has been changed.

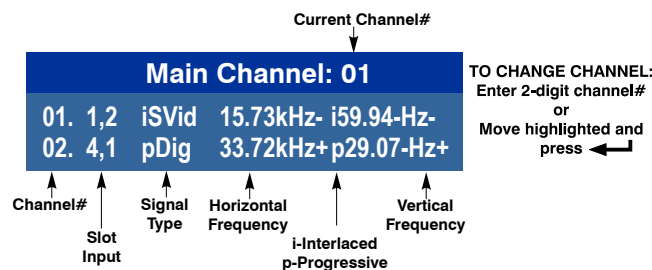

Displaying a list of channels

All available channels are listed in the **Channel Setup** menu, which describes how each channel can be accessed and provides access for editing, copying and deleting channels.

1. Press **Menu** from the presentation level to display the **Main** menu.
2. To display the **Channel Setup** menu, press 3, or move the highlight to the **Channel Setup** option and press **Enter**.

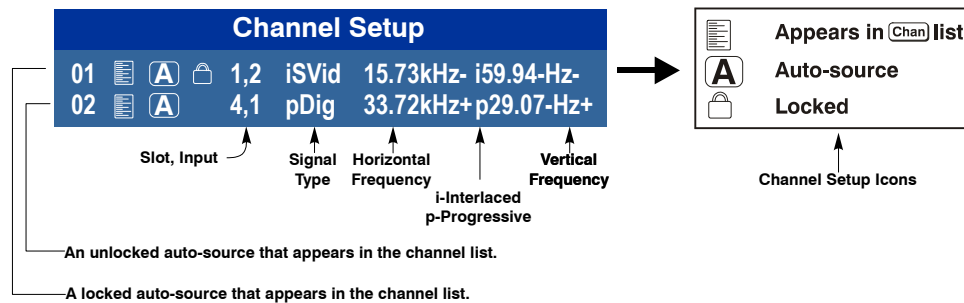

3. Use **Up Arrow Key** and **Down Arrow Key** to see the remaining channels not visible in the initial display of channels.

The channel setup icons list all defined channels. The far left column lists channel numbers defined. The values in the far right columns indicate horizontal and vertical frequencies or if there is a defined name for a channel, it appears here. The H and V frequencies do not appear if a name has been defined for the channel; instead the name is only seen. The H and V frequencies are inserted as, the name when the channel is first created. The vertical frequency is displayed with the sync polarity. The remaining columns pertain to each signal type; such as, input number, slot location, a variety of icons indicating access to each channel, and an abbreviated description of each signal type.

The channel list or the **Channel Setup** menu identifies signal types abbreviations as defined in the following table. Composite Sync on the H/C input or the V input (four-wire). These abbreviations are preceded by either an i (interlaced signals) or p (progressive signal).

The first five items in this table are analog RGB with various sync combinations indicating Sync Source when editing the channel:

Abbreviation	Signal types
—	No Sync
4WH	Composite (four wire) on HC input
4WV	Composite (four wire) on V input
SG	Sync-on-green (four wire)
5W	Separate H,V (five-wire)
5WR	Separate H,V swapped (five-wire)
SVid	S-Video
CVid	Composite Video
Dig	Digital

Abbreviation	Signal types
DSDI	Digital Dual Link HD-SDI
DVI	Digital DVI
HDMI	Digital HDMI
HSDI	Digital HD-SDI
SDI	Digital SDI
3GA	Digital 3G-SDI (Level A)
3GB	Digital 3G-SDI (Level B)
DP	DisplayPort

Copying a channel

1. Highlight the required channel in the Channel Setup menu and to activate the Select Channel Operation submenu, press **Enter**.
2. To go to the Select Channel Operation submenu, press **Enter**.
3. Select **Copy** and press **Enter**.

A new channel is created identical to original, which still remains, but it is identified with the next available number from 01-99. If you do *not* want to copy the current channel, press **Exit** to cancel and return to the previous menu. Copying channels is a quick method for creating numerous channels, each of which can then be edited and adjusted for a variety of presentations in the future.

Deleting a channel

1. Highlight the required channel in the **Channel Setup** menu and to activate the Select Channel Operation submenu, press **Enter**.
2. Select **Delete** and press **Enter**.

A window appears to confirm the deletion of this channel.

Deleting multiple channels

1. Highlight the desired channel in the Channel Setup menu and to activate the Select Channel Operation submenu, press **Enter**.
2. Select **Delete Unlocked Only** and to delete all unlocked channels, press **Enter**.
3. To delete all channels, even those that are locked, select **Delete All Channels**.

In either case, the current channel remains but is redefined from projector defaults.

For any deletion, a window appears to confirm the deletion of the required channel. Select **Cancel** (default) if you do not want to delete after all.

Editing a channel

1. To display the Main menu, press **Menu** from the presentation level.
2. To display the Channel Setup menu, press 3 or move the highlight to the Channel Setup option and press **Enter**.
3. To edit parameters shown in the Channel Setup menu, select the relevant channel and press **Enter**.
4. If required, review and/or edit the following channel setups in the Channel Edit menu:

Field	Description
Name	An alphanumeric label can be defined and/or changed here. Channel names can be up to 12 characters in length. The default name is the horizontal and vertical sync frequencies.
Channel	A two-digit channel number can be changed here. If you enter a channel number that already exists, a dialog message appears indicating that this number is already in use; assign a different channel number. You can define up to 99 channels.
Slot	1-4, corresponding to which slot in the projector's input panel the source is connected.
Input	1-6, corresponding to which input on the selected slot the source is connected to.
In Menu	If checked (default, except for automatically defined channels with unchanged parameters), this defined channel appears in the list available when Channel key is pressed. If unchecked, the channel must be accessed through Channel on the keypad or through the Auto Source function. On-screen display of the channel list is an option that must be set in the Menu Preferences menu.
Auto Select	If checked, (default), the projector can automatically locate this channel when an incoming input signal matches. If not checked, the projector can locate the selected channel only when it is directly selected with Channel on the keypad; a change in input signal does not result in a channel change.
Locked	If checked, all of the image settings for this channel are locked. If unchecked (default), all available image settings can be adjusted as required. You cannot use Auto Setup with a locked channel.
Previous Channel	Select this option to see or change Channel Edit settings for the previous channel in the Channel Setup list.
Next Channel	Select this option to see or change Channel Edit settings for the next channel in the Channel Setup list.

Configuring the lens

1. In **Configuration > Lens Settings**, configure the following:
 - **Intelligent Lens System**—Enables the **Intelligent Lens System (ILS)**. When enabled, the lens position (horizontal, vertical, focus, and zoom offsets) are stored per channel. If you change channels, the lens position changes as the new signal is being displayed. When ILS is not enabled, the lens is controlled independently of channels or input signals.

- **Manual Zoom/focus**—When this control is selected, the holding current is removed from the zoom and focus motors so that they can be changed manually. Zoom and Focus should not be adjusted manually when this control is not selected, as this results in damage to the motors.
- **Calibrate**—The lens calibration procedure is needed each time a new lens is installed in order for the ILS feature to perform reliably. This procedure calibrates; horizontal, vertical, focus, and zoom offset movements.
- **Lock All Lens Motors**—Prevents all lens motors from moving. It disables the Zoom, Focus, Horizontal and Vertical Position settings, effectively locking out any changes and overriding all other lens features. This prevents accidental lens position changes in multi-projector installations.
- **Calibrate On New Lens**—Prompts for a lens calibration each time a lens is inserted. The user is always prompted before starting the calibration.
- **Calibrate On Startup**—Check this box to initiate a 'Lens Reset' procedure on every power-up. Use this if the lens is subject to manual movement between power sessions.
- **Home Position**—Return the lens to the horizontal and vertical home position. Focus and zoom are unaffected.
- **Calibration Status**—Displays the current lens calibration status.

Configuring up the lamp

Selecting the lamp operation mode

Select between one of the following lamp operational modes in **Lamp > Lamp Operation**:

- **Lamp 1 single lamp use or Lamp 2 single lamp use** modes only use the lamp specified. If the selected lamp does not strike, the projector does not turn on.
- **Dual Lamp Use** mode uses both lamps together. The projector stays in this operational mode even if only one lamp successfully ignites. If both lamps fail to ignite, the projector goes back to standby.
- **Auto-Select a Single Lamp** mode ignites the lamp with the fewest recorded hours of on time.

Selecting the lamp mode

Select between one of the three different lamp modes in **Lamp > Lamp Mode**:

- **Maximum Brightness** mode sets the lamp to run at its highest power level.
- **Constant Intensity** mode maintains a specific brightness level over time. The brightness level can be adjusted with the **Intensity** control (see below). As the lamp ages, the projector increases power to maintain the desired brightness. This option is disabled if LiteLOC calibration has not been performed.

- **Constant Power** mode maintains a specific power level for the lamp. The power level can be adjusted with the **Power** controls (see below).

Specifying the amount of power sent to the lamp

The **Lamp > Power** control represents the amount of power sent to the lamp(s) in Watts. Lower power levels reduce brightness and extend lamp life. This control is only enabled while in Constant Power mode.

This slide bar does not update in real-time when operating in Maximum Brightness or Constant Intensity mode. To see the amount of power being applied to the lamp while in Maximum Brightness or Constant Intensity, see the Lamp Info page on the Status tab of the web interface.

Setting the target brightness

The intensity control represents the target brightness for the LiteLOC system. The value at **Lamp > Intensity** is a percentage of the maximum brightness of the lamp(s). This control is only enabled while in Constant Intensity mode.

Configuring lamp failover

Enabling the **Lamp > Single Lamp Switch on Fail** option causes the projector to automatically turn on the other lamp, should the currently operating lamp turn off during normal operation or if the currently selected lamp fails to ignite.

This control is only in effect while in the following modes:

- Lamp 1 single lamp use
- Lamp 2 single lamp use
- Auto-select a single lamp

A brief period of no light occurs before the other lamp ignites and warms up sufficiently. The operational mode of the projector may change from Lamp 1 single lamp use to Lamp 2 single lamp use or visa versa with the option enabled. For example: If lamp 1 fails to ignite and lamp 2 ignites successfully, then the operational mode changes to Lamp 2 single lamp use. This option does not change the operational mode if it is set to **Auto-select a single lamp**.

Using multiple projectors

When working with more than two projectors, work left to right, top to bottom.

When an installation requires multiple projectors, use the RS232 serial ports to daisy chain the units together and control the group with a single keypad or a computer/controller connected to the first projector. In such a network, you can choose to broadcast commands to the entire group, or use the **Proj** key as required to limit responses to an individual projector.

Alternatively, you may want to add projectors to a hub on an Ethernet network. See [Connecting multiple projectors](#) on page 39 for full routing details.

Tiling an image over multiple screens

Image tiling allows a single input image to be displayed, spread over multiple screens, with each screen displaying a fraction of the image. The image is displayed by the **m × n** array of projectors,

where m is the number of rows (1-3) and n is the number of columns (1-3). This allows the following arrays to be set up:

1x2, 2x1, 1x3, 3x1, 2x2, 2x3, 3x2, 3x3

Projectors are numbered from left to right (left column = 1), and from top to bottom (Top row = 1).

For examples:

Projector A Row 1, Col 1	Projector B Row 1, Col 2	Projector C Row 1, Col 3
	Projector C Row 2, Col 1	Projector D Row 2, Col 2

1. Set the total number of rows and columns in the array. This setting is the same on all the projectors in the array.
2. Set the relative location of the projector within the array by identifying the row number and column number for each projector.
3. Enable Tiling.

Performing preliminary calibration

All primary colors in the projector are precisely set to pre-established values to ensure that overall color performance is optimized and is as accurate as possible. Lighting and other environmental factors may slightly change how these colors appear on your screen. While the change is negligible in most cases, you may prefer to recover the originally intended color performance before trying to match colors from several projectors.

To achieve consistency use a color meter to measure the native primary colors—red, green, blue, and white—as they appear at the screen. Record these as *Color Primary Settings* in the **Service** menu (password-protected) for each projector. On the basis of these new values, which are stored in memory, each projector then automatically calculates any necessary corrections to reproduce the original factory colors under the current environmental conditions. This essentially calibrates a projector to its surroundings, compensating for factors such as screen type; lamp and/or ambient lighting and improves color accuracy and consistency in a group of projectors. It ensures a good starting point for further customizing and matching; however, is not critical for all installations.

To access the **Service** menu (password-protected) return to the factory-set color primaries. Select the **Reset to Factory Defaults** option in the **Color Primaries** submenu. Then repeat the calibration process describe above and continue with matching of colors.

Automatically correct frame delay issues in tiled images

Frame Delay Compensation attempts to automatically correct for frame delay issues which may occur in three row tiling. When enabled, and using three row tiling, the manual frame delay control is disabled.

The features that act differently when Tiling is enabled are:

- The PIP border is disabled.
- Cascading menus are turned off.

- Menus show only five items, with a scroll bar to allow the rest of the menu items to be reached.
- Projector source switching in the array is not synchronized. Therefore some latency can be seen from when the commands are issued to each projector, causing switching to not be as seamless when in a tiling configuration. When using loop-through with the Twin HDMI Input Card to distribute a signal to the tiling array, additional latency in the switching can occur during HDCP repeater negotiations with the source player.

When the **FUNC+HELP** key combination is pressed, the tiling settings are cleared. Tiled warps/keystones can be enabled through Christie Twist 1.6. Refer to the *Christie Twist User Manual* (P/N: 020-101380-xx).

Matching colors across multiple screens

In a multiple-projector wall, you want to precisely match color and intensity from image-to-image so that the full wall is as uniform as possible.

Refining the displayed colors

Once the *Color Primary Settings* are calibrated for the site (see above), use the **Color Adjustments by X,Y** or **Color Saturation** menu to further refine each projector's fundamental colors so that the hue and intensity of each color appears the same from one display to another. Once matched, you have created a single new shared range of colors or color gamut that all of your projectors can produce. This palette—named User 1, 2, 3 or 4—can be applied or disabled for a source at any time throughout a bank of adjacent displays, simplifying both the setup and maintenance of a seamless wall.

1. Set up and optimize all projector settings. You can ignore color temperature, since you are redefining color performance in this procedure, but do optimize each projector in every other aspect. Closely align all screen edges.
2. Assign projector numbers to make communications easier. Use desired keypad.
3. Use the same lamp mode for all projectors, and do the following:
 - Set Select Color Adjustment to **Max Drives**
 - Display a full white test pattern
 - Adjust lamp power and Optical Aperture until adjacent white fields appear the same brightness.
 - Display the Color Adjustments by X,Y menus for all projectors. Each menu shows the x/y coordinates defining the Max Drives color gamut for this projector.

The values shown in one (any) of the displays. Use the Copy From function to copy them into a User gamut in one projector.

PROJ 1 **PROJ 2** **PROJ 3**

Color Adjustments by X,Y	
1. Select Color Adjustment	Max Drives
2. Color Temperature	6521
3. Red X	0.655
4. Red Y	0.341
5. Green X	0.332
6. Green Y	0.575
7. Blue X	0.144
8. Blue Y	0.093
9. White X	0.320
10. White Y	0.330
11. Yellow Notch Filter	<input checked="" type="checkbox"/>
12. Auto Color Enable	<input checked="" type="checkbox"/>
13. Color Enable	Red
14. Copy From	Max Drives

Record "Max Drives" x/y values from one menu.

Red X: 0.640
Red Y: 0.350
Green X: 0.329
Green Y: 0.560
Blue X: 0.129
Blue Y: 0.100

4. In each projector, select a User color adjustment (1-4) to enable **Color Adjustments by X,Y** changes. Then enter your recorded x/y values into each menu.

PROJ 1 **PROJ 2** **PROJ 3**

Color Adjustments by X,Y	
1. Select Color Adjustment	User 2
2. Color Temperature	6521
3. Red X	0.655
4. Red Y	0.341
5. Green X	0.332
6. Green Y	0.575
7. Blue X	0.144
8. Blue Y	0.093
9. White X	0.320
10. White Y	0.330
11. Yellow Notch Filter	<input checked="" type="checkbox"/>
12. Auto Color Enable	<input checked="" type="checkbox"/>
13. Color Enable	Red
14. Copy From	Max Drives

Set to "User" (1-4)

Then copy x/y values into all projector menus.

Red X: 0.640
Red Y: 0.350
Green X: 0.329
Green Y: 0.560
Blue X: 0.129
Blue Y: 0.100

5. In each projector, judge by eye and adjust x/y coordinates slightly in the following manner:

- To match reds, decrease Red X until full field red screens match.
- To match greens, decrease Green Y until full field green screens match.
- To match blues, increase both Blue X and Blue Y until full field blue screens match. For speed, select the **Auto Color Enable** checkbox. Each color coordinate you select automatically triggers a full field display of the corresponding color.

Alternatively, use the Color Saturation menu for these adjustments or to fine tune.

These coordinate adjustments move the three color points closer together (see below) to establish a shared gamut attainable by all projectors in your group. Adjust only as necessary to

ensure that the resulting color palette is as large as possible. When done, you may need to adjust lamp power slightly.

6. All screens should now be color-matched. Apply the new User gamut to a source at any time by selecting it in the **Select Color Adjustment** list accessed in the **Advanced Image Settings menu**.

Matching colors across multiple screens

1. In the three Color Adjustment submenus (Red, Green, Blue, and White), set all main values to 1000 and the secondary values to 0, if applicable.
2. Judge the colors by eye and adjust the slide bars as needed.

Adjustments here define new x/y coordinates in the Color Adjustments by X,Y menu. For best results, use this menu after doing the color adjustment procedure. See [Refining the displayed colors on page 71](#).

Displaying picture-in-picture

Use the **Input Switching and PIP** menu to enable and define how you want to use picture-in-picture (PIP).

To control the primary image, access all picture controls through the Main menu. To control the secondary (PIP) image, access picture controls through the Input Switching and PIP menu. PIP function is disabled in 3D mode.

Enabling picture-in-picture

Press PIP on the remote if the menu is not present.

Toggle between displaying two sources at once (Main and PIP images) and the primary or main source only. This checkbox turns the secondary source on and off.

Primary Image
Adjust through
Main menu
navigation.

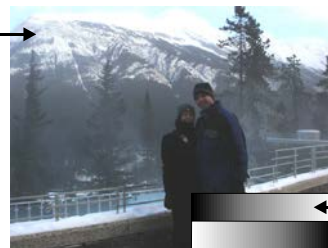

Secondary
(PIP) Image
Adjust through
PIP menu.

Selecting the main and picture-in-picture inputs

1. Select **Input Switching & PIP**.
2. From the list of active inputs, select one to be used as the primary or main image.
3. From the list of active inputs, select one to be used as the secondary or PIP.

Swapping the main and picture-in-picture inputs

Toggle the current PIP relationship so that the primary (main) image becomes secondary (PIP), and the secondary image becomes primary. Swapping is available only when PIP is enabled. You may experience a slight delay when swapping the primary and secondary images.

Changing the size and position of picture-in-picture

Most controls in the PIP Size and Position menu adjust the PIP (secondary) image in the same fashion as their counterparts in the main **Size and Position** menu.

1. Select **Input Switching & PIP > PIP Windows**.
2. Set the location of the PIP (secondary) image in the display.

Configuring the picture-in-picture image

The **Input Switching & PIP > PIP Image Settings** control adjusts the PIP (secondary) image in the same fashion as their counter parts in the main Image Settings menu.

Fading between images

Use **Input Switching & PIP > Fade Time** to set the amount of time (in seconds) it takes to fade between images on a source switch and fades in the PIP image.

Locking image frames to the input

When the selection is set to **Frame Lock**, output image frames are locked to the input. When locked, the output is always locked to the primary input, never the secondary image. Select **Free Run** and this sets the output to close at 60Hz for all sources.

Seamless switching is only available when free run is selected. When switching to a new input with frame locking enabled, the image is black for the short period while the system locks onto the new input.

Automatically searching for input signals

When **Input Switching & PIP > Auto Input Switching** is enabled, the system continually searches for the next valid signal when no signal is present or when loss of sync occurs on the current user selected input. In the case of multiple signals to choose from, the order is based on slot, followed by inputs on that slot.

Configuring the HDMI output options

Select **HDMI Output Loop Source > Direct Loop** to directly pass-through the HDMI input signals (from the same Twin HDMI Input Card). The Input1 signal is looped to Output1 and the Input2 is looped to Output2.

Select **Main/Secondary Loop** to loop the main and secondary video to the outputs (regardless of which card these signal originate from). The main video signal is looped to Output1 and the Secondary video signal is looped to Output2.

Select **Disable** to shut off the HDMI outputs completely.

Looping video signals

In situations where a Twin HDMI Input card is being used to loop signals out to another projector, **Standby Active Loop-Through** ensures that video signals continue to be looped out when the projector enters standby power mode.

When the projector is in standby mode and **Standby Active Loop-Through** is selected, limited channel control is available—inputs can be switched, perform auto setup and some limited input settings can be modified.

3D

The projector is capable of displaying stereoscopic 3D video sources and relies on additional hardware; such as stereo emitters and glasses to complete the display system.

Images generated from a stereo 3D-video source consist of a series of images (*frames*) that alternate quickly between two slightly different view points, corresponding to our left and right eyes. When these frames are displayed fast enough and viewed with special stereo glasses synchronized to the left/right (L/R) changes, the resulting image appears with the same depth and perspective that is sensed in the real world.

The type of special glasses can be active stereo or passive stereo glasses depending on the type of stereo controllers and screen used.

Requirements

Stereo 3D applications require a stereo 3D-capable source, special hardware/software setups described below, and the *3D Settings* menu option to control the processing, synchronizing and displaying of your stereoscopic 3D source material.

Hardware

- Christie 3D version of the projector.
- Christie 3D Stereo Sync Cable (required for 3D models; ensures minimum frame delay).
- A source, usually a computer with a stereo 3D graphics card capable of displaying progressive scan (alternating frames) of OpenGL quad buffered stereo 3D applications (suggested cards include ATI or NVIDIA), and running under *Windows (2000, XP), Windows 7, Linux, IRIX, HP-UX, OS-X* or *Solaris* operating systems.
- Emitter for controlling active shutter glasses.
- An appropriate qualified device that mounts in front of the lens of the projector that processes the light from the lens into a passive polarized light. Contact your Immersive dealer for more information.

Software or content:

- Any 3D computer software that supports active or sequential 3D stereo on a supported computer with a supported graphics card.
- A video stream from video source that has been prepared to be sequential content. The projector supports stereo signals prepared on either a compatible dual and single link HDSDI format. The VGA port does not support 3D.

- Frame locked passive sources are also compatible with the projector with the appropriate primary and secondary input card.

Connecting the 3D stereo sync cable

This GPIO cable provides the means for synchronizing the various components in your 3D system. Your source, projector display output, and emitters or 3D passive filter system can then operate together with precision to minimize cross-talk and color artifacts. Connect as shown below.

For Easy Rider models, inputs A and B are not required, but recommended to ensure that stereo is configured correctly, especially for multiple projector setups.

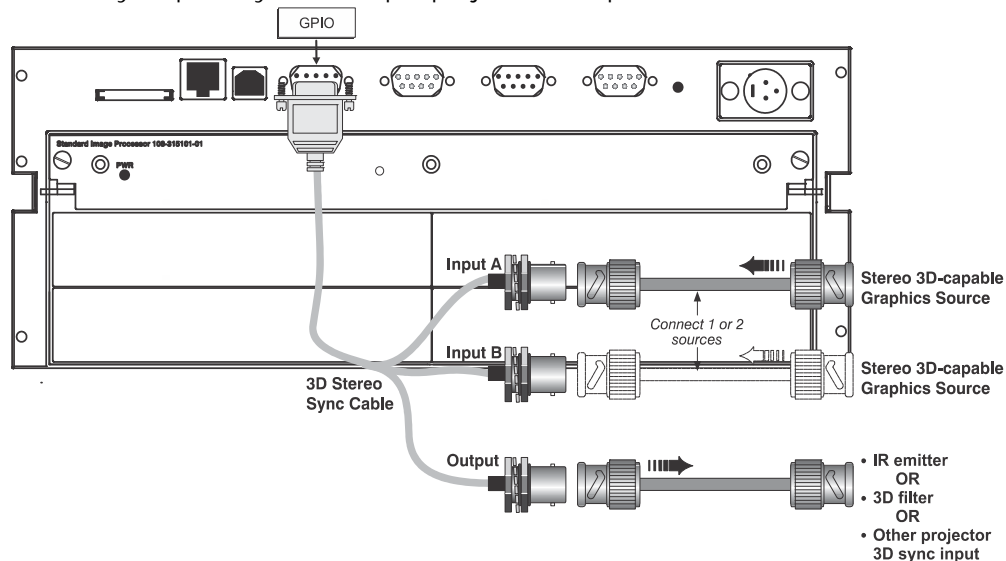

Connecting Two Stereo 3D Sync Inputs (recommended for multiple sources). Connect your video card's stereo 3D sync cable to either Input A or either Input B on the 3D Stereo Sync Cable. These inputs are provided to allow you to connect two different Stereo 3D sources and conveniently switch the display back-and-forth between them.

Connecting One Stereo 3D Sync Output Connect the 3D Stereo Sync Cable output to your stereo 3D sync emitter or 3D passive filter system, PZE device. The L/R switching of the device can then be synchronized according to the controlling signal of choice—either the source input signal or the internally generated signal—as set in the 3D Settings menu.

Active and passive Stereo 3D configurations

Typical hardware configurations for active and passive Stereo 3D systems are shown below.

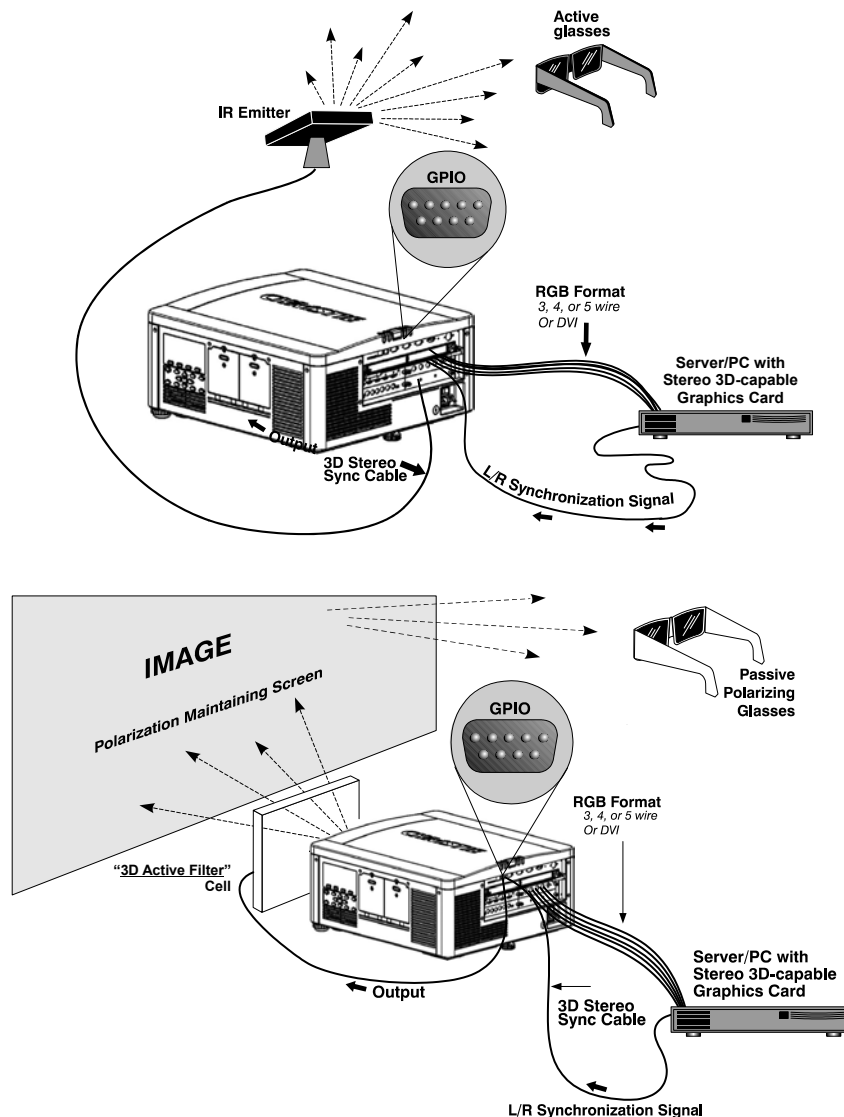

- **Appropriate Stereo 3D Source**—Use stereo 3D application software with your 3D video source (usually a workstation or PC). The source must also provide a separate stereo 3D synchronization signal that precisely controls when left/right fields are visible through the viewer's glasses. This separate signal is usually provided using a VESA 3-pin stereo port.
- **IR Emitter/3D Passive Filter System**—In response to an incoming sync signal, the emitter emits L/R infrared signals to a receiver in active 3D shutter glasses, causing the L/R shutters to alternately open and close for active stereo 3D applications. Likewise, a 3D passive filter system placed in front of the lens responds to an incoming sync signal and alternately polarizes the L/R frames viewed with passive glasses for active stereo 3D applications. Connecting one of the 3D

Stereo Sync Cable outputs to an emitter/3D passive filter system allows you to synchronize your stereo 3D display with the glasses.

- **Glasses (Active/Passive)**—Active glasses differ in speed and performance. Consult the documentation for your glasses and keep their specifications in mind when configuring your source signal. The input signal must be optimized for the available shutter speed to prevent obvious ghosting of image content (known as cross-talk in stereo 3D applications) and other more subtle color artifacts. Such problems indicate that the eyes are detecting portions of the opposing frame due to an out-of-sync system, and can occur in either active or passive stereo 3D configurations. Adjust the Dark Interval setting to reduce ghosting.

In the 3D Settings menu, the correct 3D Stereo Sync Delay setting should help to synchronize glasses with the displayed images.

In a passive system, where glasses do not have shutters and instead depend on the speed and accuracy of the 3D passive filter system, the signal must be synchronized to the projector using the 3D Stereo Sync Cable.

3D settings

Use the options in the 3D Settings menu to make the timing adjustments necessary for realistic simulation and 3D images.

- **3D State**—Informs you what state the projector is in: Off, Missing Secondary Signal, Not Frame Locked, Secondary Frequency Mismatch, High Bandwidth Not Supported, Stereo Sync Not Detected, Stereo Sync Invalid, and Invalid Frequency. This is read only.
- **3D Mode**—Select the mode of your 3D operation.
 - **Off**—3D operation is disabled.
 - **Auto 3D**—Attempts to automatically determine which 3D mode to use based on auxiliary video data, e.g. HDMI info frame.
 - **Native 3D**—All content is shown at a native frame rate of 96–120 Hz input and output.
 - **Frame Doubled 3D**—3D Content from a single 48-60Hz signal (24/30Hz per eye) is displayed twice to provide a 3D content to be viewed at 96-120Hz.
 - **Dual Input 3D**—Content from two independent 48-60Hz passive frame locked sources are interleaved into a native 96-120Hz native frame rate. This requires an optional input module and both signals must be from the same signal type.
 - **Side-by-Side 3D**—Content is transmitted with each eye beside each other in a single frame, and is extracted and scaled appropriately to show in an alternate-frame sequence. Typically used for broadcast 3D-TV.
 - **Top-and-Bottom 3D**—Content is transmitted with each eye above one another in a single frame at half resolution, and is extracted and scaled to show in an alternate-frame sequence.
 - **Frame Packed 3D**—Content is transmitted with each eye at full resolution in a double-sized frame, and is extracted to show in an alternate-frame sequence. Typically used for Blu-ray 3D movies and 3D video gaming.

- Triple-Flash 3D**—3D Content from a single 48Hz signal (24Hz per eye) is displayed three times to provide you a 3D image to be viewed at 144Hz.
- Dark Interval**—Artificially increases the amount of dark time between displayed frames for stereoscopic 3D images. Higher settings provide more time for shutters in 3D glasses to open and close, ensuring that each eye sees the full display intended for it. Symptoms of cross talk or color artifacts can indicate the need for adjustment. The Dark Interval range of adjustment depends on the vertical frequency of your source—the higher the frequency, the smaller the range. Default setting is 2.3ms.
- 3D Sync Input**—The 3D sync signal is generated by the 3D source to insure left/right eye content is synchronized to the projector and you. The projector has the ability to physically connect to two different sources. Ensure that the correct 3D sync input is selected (either Input A or Input B) with each 3D signal source. If none/internal is selected, the projector generates the sync internally and content is displayed; however, there is a 50% chance that the content is displayed with the left/right eyes swapped (from the remote, press FUNC 6-9 to swap the eyes). This function is not used in Interleaved 3D mode. Each eye receives a selected input and no 3D sync input is required.

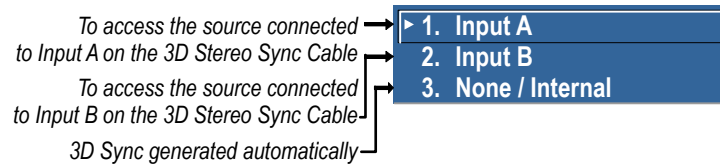

- 3D Sync Output**—This option defines whether the 3D Sync is output and controls how it is processed. It is only valid when an optional cable is used to connect stereo 3D signals to the projector using the GPIO port. When there is no 3D signal, Sync Output should be **Off**. Typically only the last projector in the 3D Stereo cable chain is connected to the emitter and should specify **To Emitter**. All other projectors should select **To Next Input** if other projectors are used in the chain.

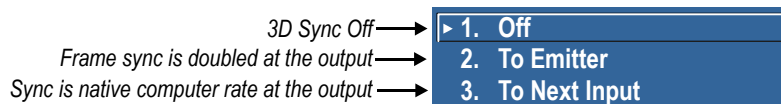

- 3D Stereo Sync Delay**—Adjust the output 3D emitter delay (in milliseconds) to match the active glasses to the L/R frames of the projector. Proper adjustment of this delay eliminates cross talk and odd colors caused by timing differences between the glasses and the projected image. Your specified delay is added after sync locking.
- 3D Test Pattern**—Enables a 3D test pattern for diagnostics. The scrolling diagonal lines indicate how well left and right are synchronized. If ghosting is occurring the input may have to be switched or inverted. Adjustments to the emitter delay can also help correct the synchronization. To verify that your 3D is setup correctly, a small set of Ls are visible when you close your right eye and a small set of Rs are visible when you close your left eye.
- Frame Locking**—Enable or disable Frame Lock. When set to Frame Lock, if possible output image frames are locked to the input. When Locked, the output is always locked to the primary input and never the

secondary image, when using Dual input 3D. Free Run sets the output to close to 60Hz for all sources. This control must be set to locked if a 3D-Stereo signal is used.

- **Set Frame Delay**—Delays the output signal timing relative to the input signal timing by a fraction of a frame, and up to several frames. The minimum latency can vary based on the amount of scaling applied to the image. When using keystone or warping, an additional latency is required, depending on the amount of warp. The control is only available when the input signal is frame locked. In free run mode, or in cases where the signal cannot be frame locked, the minimum latency defined by the scaling and keystone/warp is applied to the signal.
- **Actual Frame Delay**—Displays the actual frame delay reading.
- **Full Screen Eye-Motion Filter**—Check this control to apply the Eye-Motion Filter to the entire screen, rather than applying just to the edge blending regions. Helps with posterization effects, sometimes seen in color ramps when viewing stereoscopic images.
- **Eye-Motion Filter**—Adjust this filter to reduce saccadic eye-motion artifacts, sometimes noticeable in edge blending regions. Too much filtering may result in loss of detail. For best results, adjust this setting while positioned at the nominal screen-viewing distance.
- **Edit Secondary Channel Settings**—When using Dual Input 3D, this allows you the option to independently control primary and secondary channel settings, or to use the same setting for both links. By default, this control is unchecked, meaning any settings applied to the primary input also applies to the secondary input. In this case, the secondary channel settings cannot be set. When checked, the secondary channel settings become editable.
- **Main Input**—Select an input from the drop-down list.
- **Secondary Input**—Select an input to be used as secondary input in a Dual Input 3D setup.
- **Display 3D Message Boxes**—Enable/Disable message boxes that are triggered by 3D setup. No message box is shown in Off and Valid state.

Example of 3D multiple display setup

1. Setup the warp and blends.
2. If necessary, shift or scale your image to fit the display.
3. Set all projectors to the largest minimum Frame Delay value that the worst case projector in the array can achieve.
4. To enable 3D mode on all projectors, select **Main Menu > Image Settings > Advanced Image Settings > 3D Settings**
5. Set all projectors 3D Sync Output to **Next Projector** with the exception of the last projector; select **To Emitter**.
6. Connect the PC emitter sync to either **Input A** (or B) on the 3D dongle.
7. Connect the output from the 3D dongle in the first projector to **Input A** (or B) on the next projector in the array.
8. Repeat the same procedure to all projectors except the last projector in the array. Route the Sync output from the 3D dongle to the emitter. For the last projector, route the sync input.
9. If your emitter has a reverse setting ensure it is set to the Off position.

10. Set all projectors to **3D Sync Input A** (or B) depending on your selection in Step 6 and 7.
11. Apply the 3D test pattern to all projectors.
12. Put on your 3D glasses.
13. When 3D is setup correctly, a small set of Ls are visible by closing your right eye and a small set of Rs are visible when closing your left eye.
14. If necessary, adjust the dark interval settings until the test pattern sees the least amount of ghosting for each projector.
15. Adjust the 3D Sync Delay on the last projector in your array to match the optimal sampling point for the glasses being used.

The default auto setup value is typically good for all glasses.

16. Turn off the 3D test pattern on each projector.

Your 3D content should look optimal.

3D SETUP

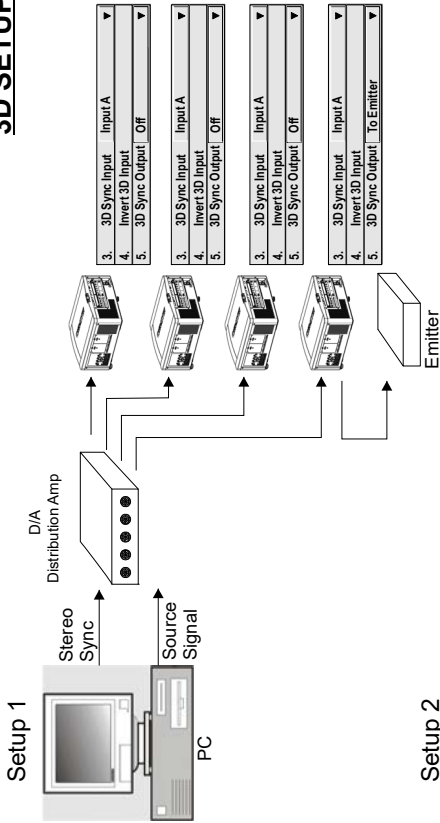

Setup 1

Stereo Sync is split using a distribution amplifier
 Each projector sees the same Stereo Sync
 Any projector can send Output Sync to the Emitter

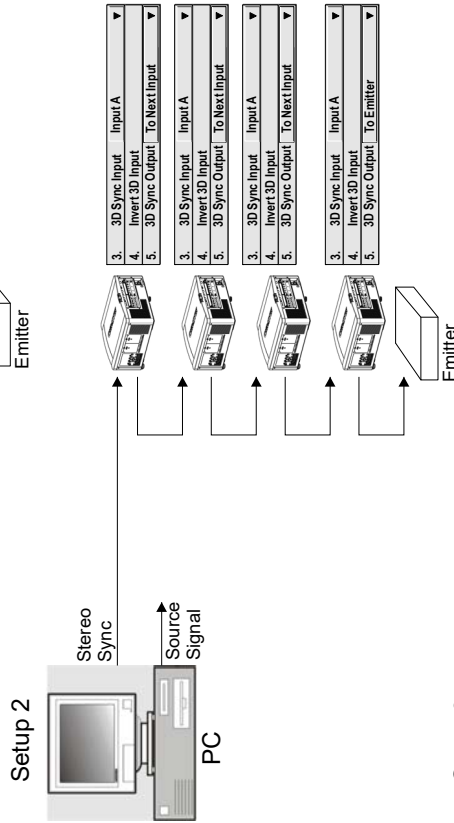

Setup 2

Stereo Sync from the source is only sent to the first projector in the system
 Each projector provides the same sync signal to the next
 The last projector in the system sends output to the Emitter

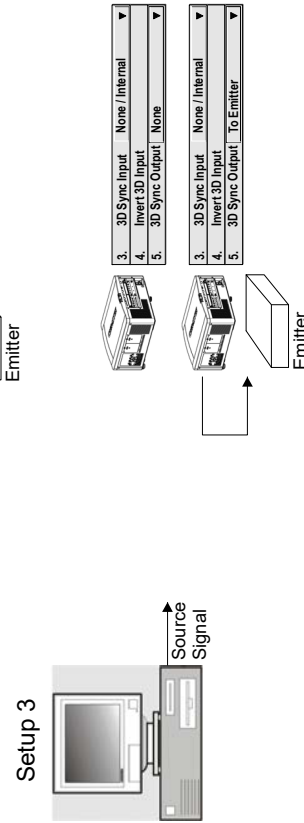

Setup 3

Internal sync is generated based on the source timing
 Each projector is setup as a stand alone unit so the Inverted/Non-Inverted setting may vary between projectors
 Any projector can output to the Emitter

NOTE: Using Internal Sync is not recommended unless absolutely necessary or a quick test setup is desired since the system may require adjustment of left/right frames every time the projector is powered on or switches inputs.

Performing diagnostics and calibration

In **Configuration > Diagnostics & Calibration**, configure the following:

- **Test Pattern**—Choose the desired internal test pattern to display, or select **OFF** to turn off a test pattern. Alternatively, use the **Test** key for cycling through test patterns.
- **Grey Level**—Set the level of grey for displaying in the full grey field test pattern.
- **Freeze Image**—Enter a check mark to freeze (stop) an image on a single frame. Use this diagnostic tool to examine in detail a still version of an incoming image that cannot be frozen at the source. For example, in moving images it is sometimes difficult to observe artifacts such as external de-interlacing/resizing and signal noise. Remove the check mark to return to normal.
- **Color Enabled**—Select which color(s) you want to see. Use this while working with color temperature, input levels or other special setup parameters. Colors can be enabled/disabled by entering the corresponding function code listed on the back of the standard remote keypad.
- **Input Peak Detector**—A fast method for defining individual input levels, and improving the accuracy of input levels set by the Auto Input Level function. Enabling the **Peak Detector** activates a special operating mode for detecting only pixels that are considered black or white—all other levels are displayed as a mid-level grey. When used with a 16-step grey scale pattern in which the two black and white bands are known to be at opposite edges of the image, you can watch these isolated areas while adjusting individual black levels and input drives until both bands are just visible. Images from this source display correct blacks and whites without crushing or washing out. If using Peak Detector with PIP, both images must have the same color space.
- **Input Level Detector**—Enable specific thresholds for blacks and whites. Input levels that fall below a specified level value (see below) are displayed as black, and all others are displayed as white. To use:
 - a. Enable **Input Level Detector** and display a continuous grey scale.
 - b. Set **Level Detector Threshold** to near black (such as 200).
 - c. Adjust Offsets to minimize area of black stripe.
 - d. Set **Level Detector Threshold** to near white (such as 800).
 - e. Adjust Gains to minimize area of white stripe.
- **Level Detector Threshold**—Define the value to be used by the **Input Level Detector** in recognizing blacks and whites.
- **Aspect Ratio Overlay**—Check this box to display an overlay pattern over the image. The overlay shows the boxes corresponding to the size and shape of different aspect ratios.
- **Test Pattern Color Swap**—Swap the green and red color when drawing the Grid test pattern. This may be helpful when adjusting convergence on the projector.
- **Calibrate LiteLOC**—The LiteLOC calibration process must be run to calibrate the LiteLOC sensor on all model types. Constant Intensity mode cannot operate correctly if the calibration has not been performed. The calibration must be done in Dual Lamp mode, after the lamps have warmed up for at least five minutes. The shutter closes for the duration of the calibration, and automatically open again when the calibration is complete.

- **Freeze Image During Auto Setup:** Hides temporary image artifacts that may appear during the auto setup procedure. Available with 3D option only.S

Adjusting the image

The most commonly used options for image adjustments are accessed through two menus: Size and Position (Menu 1) and Image Settings (Menu 2), both of which appear in the Main menu. From either of these two menus, you can change settings affecting the image from the current channel by working with the appropriate slide bars, checkboxes and lists. **Exit** returns to the previous menu (or to the presentation, if from the Main menu) and accept any changes you may have entered. Settings are saved with the current channel.

From your presentation, you can access any of the individual options in these menus by pressing **Menu** followed by the appropriate two-digit number representing their location in the menu system. For example, press **Menu** 24 to quickly access the Color Space option in the Image Settings menu.



Notice. Failure to comply with the following may result in property damage.

- For certain options, preference may be to use a direct key from presentation level to go directly to a particular option without traveling through the menu system (available for certain display parameters only). For example, press **Contrast** to access the contrast slide bar immediately. Press **Exit** to return to your presentation.
- To hide direct slide bars, disable the **Display Slide bars** checkbox in the Menu Preferences menu.
- To hide the entire menu system from view, turn off the on-screen display by pressing **OSD** then the **Down Arrow Key**.

Automatically optimizing display parameters

For a good and efficient first step in perfecting the image, press **Auto setup** on the remote. This optimizes critical display parameters such as size, position, and pixel tracking based on the type of incoming source. Auto Setup can save considerable setup time and you can still adjust the image as described below.

The best auto setup is obtained under the following conditions:

- Input levels, it is best to have an image with saturated (bright) colors.
- Phase, high contrast edges are needed.

To determine active window size:

- Video images should have whites and blacks in the image
- Wide range video images should have content (including white) that extends to all edges of the image.

When **AUTO** is pressed, the auto setup process shall begin. In some cases for analog video a menu may appear that presents multiple choices that allows the user to select the format that best suits their source. This selection helps the auto setup get the correct settings for the tracking and phase controls for analog sources that contain the same number of active lines, but have a different aspect ratios.

- All digital and decoder option cards do not present an additional auto setup menu since digital hardware provides enough information to perform the correct auto setup.
- Analog PC graphics sources (four/five-wire sync) present a list of formats based on the current active lines detected in the video.
- Analog Video Sources (three wire sync on green) always have the options **Default** and **Advanced**. Video sources use a look up table to determine their format based on video standards. The **Advanced** auto setup selection measures the start pixel and start line whereas **Default** uses the table values as is.

Selecting a test pattern

1. Select **Configuration > Geometry and Color > Test Pattern**.
2. Choose the required internal test pattern, or select OFF to turn off a test pattern. Alternatively, use the **Test** key for cycling through test patterns.

Changing the size and position of the image

Increase or decrease the size of your image, change its proportion (aspect ratio), move the image to a specific area of the screen, and refine other related parameters. Use **Size and Position** controls to match the image precisely to the screen used at the site. Changes made in the Size and Position menu are applied immediately and are saved when you exit the menu (press **Exit** or **Menu**).

Resize presets

The same resize presets are available to all HD and SXGA+ screen models. However, the graphics used to describe each preset in this section are of the SXGA+ models only.

Resize Presets displays an image in its native resolution (no resizing) or resizes the image by maximizing either the height, width or both height and width, or resizes to the maximum size possible while keeping the original aspect ratio.

Size, Position and **Blanking** parameters automatically adjust accordingly or, if **Blanking** is set first, which defines an active input area; **Resize Preset** scaling occurs in this region of interest only. Resizing options are explained below.

By default, when displaying a new source your image uses as much of the display area as possible for the type of incoming source data, but with minimal or no changes to aspect ratio.

The custom re-size descriptor automatically appears in the Size and Position menu when any of the values for Size, Vertical Stretch, H-Position, V-Position or Blanking do not correspond to those for a preset. This option is not offered in the Resize Presets list.

Resize Presets	
1. Default	= maximize for current source
2. No Resizing	= display in native resolution
3. Full Size	= fill the screen (regardless of source)
4. Full Width	= fill display width & keep aspect ratio
5. Full Height	= fill display height & keep aspect ratio
6. Anamorphic	= retain 16:9 aspect ratio

Custom (not selectable) = non-preset values for Size, Vertical Stretch, H-Position, V-Position and/or Blanking

- Select **Default** for most sources (factory default). The image is centered and displayed as large as possible depending on the type of source.

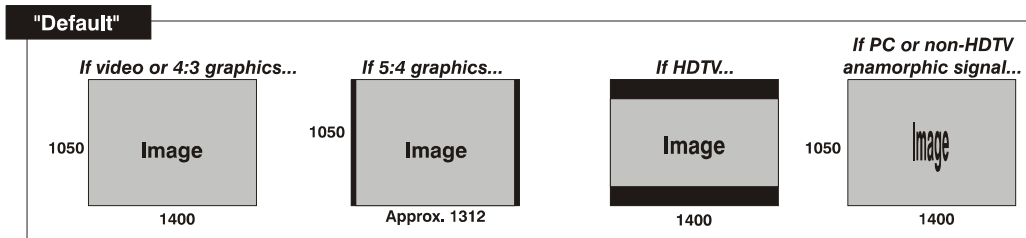

- **No resizing** displays the image in its native resolution, which may or may not match the projector's resolution. For example, for a source with a native resolution of 800 x 600, No Resizing in an SXGA+ projector uses the central 800 x 600 pixels and have a black border. The black border areas are unused areas, see below.

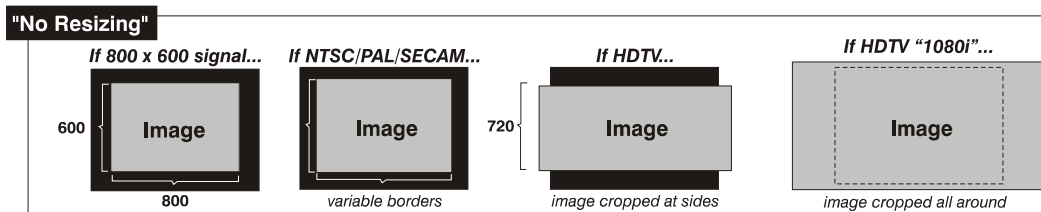

- **Full size** uses all pixels for displaying the image, regardless of source or original aspect ratio. Incoming source material having a different aspect ratio than the projector is stretched for display.

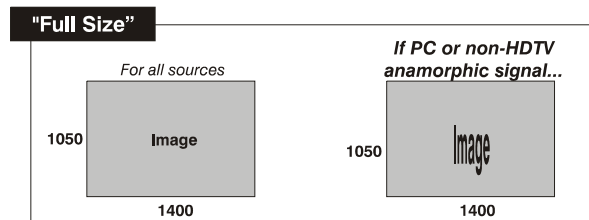

- **Full width** fills the display from left-to-right without changing the original aspect ratio of the image. Depending on the source, data at the top and bottom may be discarded (cropped), or the display may have black borders at the top and bottom (called letter boxed).

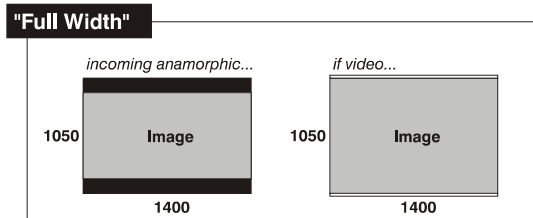

- **Full height** fills the display from top-to-bottom. Depending on the source, this may create borders.

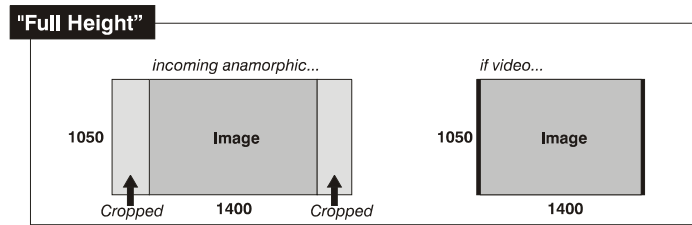

- **Anamorphic** displays an anamorphic image in its native 16:9 aspect ratio. The image fills the screen from side-to-side and be centered between black bars at top and bottom.

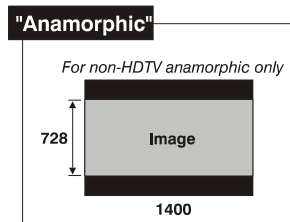

Size

Controls both the image *width* and *height* in tandem, maintaining the current aspect ratio of the displayed signal data.

Vertical Stretch

Adjusts the *height* of the image while keeping the width constant. Use *Vertical Stretch* to change the aspect ratio of the display.

Pixel Track

Steady flickering or several soft vertical stripes or bands across the entire image indicates poor pixel tracking. Proper pixel tracking ensures that the image quality is consistent across the screen, the aspect ratio is maintained, and that the pixel phase can be optimized (described below). Tracking determines the frequency of the pixel-sampling clock, indicated by the number of incoming pixels per line, so that all pixels generated by a particular source are sampled. By default, the projector samples at the correct frequency for most sources.

For best results, use a test pattern such as a smooth grey consisting of a clear pattern of black and white pixels, or a similar half-on, half-off graphic image, such as the Windows 2000 shutdown screen. Adjust the slide bar until the vertical stripes broaden to the point where one large stripe fills the image. If the image still exhibits some shimmer or noise, adjust the Pixel Phase.

Pixel Phase

Adjust pixel phase when the image (usually from an RGB source) still shows shimmer or noise after pixel tracking is optimized. Pixel phase adjusts the phase of the pixel-sampling clock relative to the incoming signal.

Adjust the slide bar until the image stabilizes and each pixel is clearly defined. You may notice that you can stabilize the image at more than one point. Adjust Pixel Phase after Pixel Track.

If some shimmer from a video or HDTV source persists, use the Filter control to remove high-frequency noise from the signal.

H-Position

Moves the image right or left within the area of available pixels. The value shown represents where the approximate center of the image lies in relation to the total number of pixels available horizontally. This varies widely according to the signal; watch the image while adjusting.

V-Position

Moves the image up or down within the area of available pixels. The value shown represents the approximate center of the image in relation to the total number of pixels available vertically. This varies widely according to the signal; watch the image while adjusting.

Keep Aspect On Auto Setup

Ensures that auto setup for any source maintains the input aspect ratio when the default size is calculated. If disabled and the source is not a special case video source where a default stretch is defined, the source is scaled to fit the platform.

Configuring how an image is cropped

Blanking defines the size of the Active Input Window, or area of interest, and crop the image so that unwanted edges are removed from the display (changed to black). The range of adjustment depends on the source resolution and other factors.

1. In the **Size and Position** menu, select **Blanking**.

The Active Input Window value indicates the current size of your displayed data or region-of-interest as defined by the blanking controls. By default, the projector automatically determines what portion of its full resolution to use, and pixels in the surrounding borders are turned off.

Blanking a PIP image resembles zoom. For example, left Blanking zooms the right side of the PIP image; Right Blanking zooms the left side. There are no black bars.

2. To specify a specific active input window size by adjust one or more Blank settings.

For example, if you have blanked (cropped) 100 pixels from both the left and right edges of an incoming source of 1400 x 1050, the remaining active input window is reduced to 1200 x 1050.

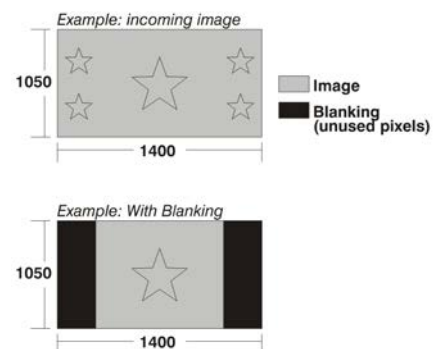

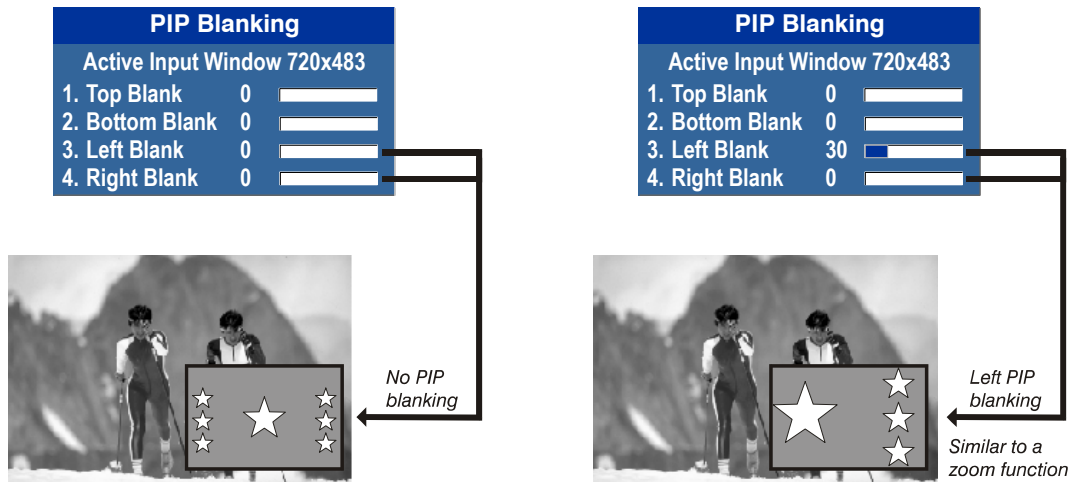

Adjusting an image for keystone correction

Keystone is typically caused by tilting the projector in relation to the screen so the lens surface and screen are no longer parallel to each other. Vertical keystone is used to correct a keystone image shape in which the top and bottom borders of the image are unequal in length, and both sides of the image are inclined toward the top or bottom edge.



Horizontal keystone is used to correct a keystone image shape in which the left and right borders of the image are unequal in length, and the top and bottom are slanted to one of the sides.

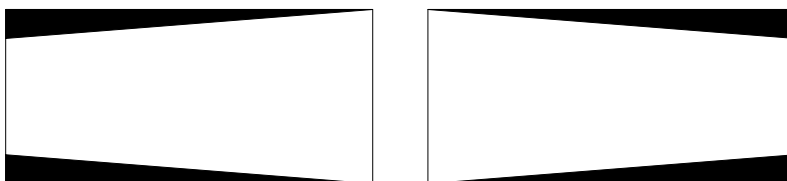

All settings to adjust keystone are in the **Geometry Correction** submenu. **Brightness Uniformity**, **Edge Blending** and **Black Level Blending** should be disabled before performing Keystone adjustments.

1. Enable keystone adjustments by selecting **Keystone** from the **Geometry Correction** drop down list. This enables the controls for performing 1D or 2D keystone adjustments.
2. Select a test pattern. Christie recommends using the Grid test pattern.

3. Perform coarse keystone adjustment by using the Horizontal or Vertical Adjust setting. Use the left and right arrow keys to make the adjustment.

The corner cursors are a guide as to how the image needs to be adjusted. The outside edge of a cursor is the outside edge of the image. It may not be possible to exactly match the screen dimensions with the horizontal and vertical keystone controls, but these settings can be refined when the 2D keystone settings are adjusted.

4. When adjustment of the corners is complete, click **OK**.

A message is displayed indicating that the projector is processing the request. The settings are applied to the displayed image, and take approximately 10 seconds. If vertical keystone adjustments have been made, starting to do any horizontal keystone adjustments erase the vertical settings, and vice versa.

5. After the Horizontal or Vertical adjustments have been made, selecting 2D Keystone adjustments retains these settings. Fine adjustment can now be made by moving any single corner separately.
6. Use the arrow keys to move to the required corner. The current corner is displayed in red.
7. Press **Enter** to select the corner. The current corner is displayed in green.
8. Use the arrow keys to move the selected corner to match the screen.
9. To save that position for the corner press **Enter** again.
10. Repeat Steps 6 to 9 to adjust all four corners until they match the screen.
11. To apply the new corner positions to the image select **OK**. A message is displayed for approximately 10 seconds indicating that the projector is processing the request.

Under certain combinations of extreme keystone co-ordinates and specific signal frequency, a keystone image may result that is outside the bandwidth limitations of the projector. When attempting to apply the keystone settings, a message appears on the on-screen display, indicating that the bandwidth has been exceeded and the keystone cannot be applied. The cursor co-ordinates for keystone adjustment remains at the failed keystone position. This allows the user to make minor changes and attempt to reapply the corner settings. Either the co-ordinates must be adjusted, or the free run frequency must be changed to fall within the allowed bandwidth.

The **Func+Help** key combination immediately disables the **Keystone**, **Brightness Uniformity**, **Edge Blending** and **Black Level Blending** features. This is helpful when, in some extreme keystone configurations, some image corruption may appear and/or the menus may not be readable. Although **Func+Help** disables these features, it does not overwrite their settings. If keystone is enabled again, the same image corruption may occur. After pressing **Func+Help**, Christie recommends to immediately reset keystone settings, which sets all keystone co-ordinates to zero.

Adjusting the main image

Use the **Image Settings** menu to alter your main image without affecting its size or position. Changes made are applied immediately and are saved when you exit the menu (press **Exit** or **Menu**). Options not available for the projector model or source are disabled and appear dim (grey).

- **Contrast**—Contrast increases or decreases the perceived difference between light and dark areas of your image (0-100). For best results, keep close to 50. Start with a lower value and

increase so that whites remain bright but are not distorted or tinted, and that light areas do not become white. If the environment lighting changes, an adjustment of Gamma is recommended.

- **Brightness**—Increases or decreases the amount of black in the image (0-100). For best results, keep close to 50. Start with a high value and decrease so that dark areas do not become black. Conversely, high brightness changes black to dark grey, causing washed-out images.
- **Yellow Notch Filter**—Yellow Notch Filter (YNF) is a channel based control with an additional global control, which honors the last request. After enabling YNF, switching to a channel that does not use YNF and the YNF filter is removed or disabled. Changes to the global control affect the YNF filter.
- **Color Space**—Determines how the color components of an analog input signal are decoded for accurate color in the display. Useful only for analog signals and certain digital sources. Although color space for these analog signals is automatically determined by the projector. You may want to override this and manually set a color space. For some signals, the color space function is entirely automatic and the list is disabled.

Configure the video sources

The **Video Options** submenu is used with video sources only.

- **Enable Decoder (AGC)**—AGC affects decoded video images only. Enter a check mark (default) in most instances. Activate the decoder's AGC circuit to ensure properly bright images. Delete the check mark if a decoded video image exhibits strange color artifacts such as stripes in highly saturated colors, indicating an incompatibility between this source and the AGC.
- **Video Standard**—For most available video standards, the projector automatically detects the incoming horizontal and vertical frequencies and sets the projector's processing of this signal to the corresponding standard. The current video standard name appears in the **Video Options** submenu, and includes an A if it is auto-detected. Press **Enter** to view or select a different video standard from those available to the projector; any that are disabled have frequency characteristics that differ from those of the incoming signal. Selecting a specific standard forces the projector to process the signal according to this standard.

Best results are obtained with defined channels. Otherwise, switching from one video source to another can sometimes cause slight disturbances in the display, indicating that the Auto function is struggling. Recover by briefly selecting a different video standard, then going back.

Standard	Where used (subject to change)
PAL	Most of Europe, China, Australia, some of South America, some of Africa
NTSC	North America and Japan
SECAM	France, Eastern Europe, most of Africa
NTSC 4.43	A tape-only standard for partially-translated hybrid signals
PAL-M	Brazil
PAL-NC	Argentina, Chile, other Latin American countries

Standard	Where used (subject to change)
PAL 60	
<p>Note: Generally, use Auto for all instances except a poor quality input signal or a black-and-white video signal. To detect and display such signals, select the relevant standard from the list.</p>	

- **Input Video Black**—Compensates for incoming elevated black levels present in certain video signals, and ensures that blacks in the display are neither crushed such as, where dark greys appear black) nor excessively elevated (such as, where blacks appear dark grey). By default, the projector automatically determines the best setting according to the type of incoming video signal:
 - **0 IRE**—Used for DVD output with enhanced black, SECAM, most PAL standards, and Japanese NTSC.
 - **7.5 IRE**—Used for most NTSC video signals.

For some types of video, you can override the setting. The control is disabled for other types of video (and all graphics sources). Generally, if black appears crushed when brightness is 50, choose **0 IRE**. If black appears excessively elevated, use **7.5 IRE**.

- **Color**—Adjusts the color saturation level. Lower settings produce less saturated colors, for example a setting of 0 produces a black and white image. If the color level is too high, colors are overpowering and unrealistic.
- **Tint**—Adjusts the red/green color hue for true color reproduction of video and HDTV signals. For best results, adjust tint while displaying an external test pattern. Christie recommends that tint remain at its default setting.
- **Filter**—The proper filter setting is automatically set for virtually all signals, and rarely needs to be changed. Override the only if standard pixel tracking and phase adjustments do not adequately clear up a noisy video signal, or if a graphics signal appears overly soft. Both instances indicate that Filter may be set to the wrong option.
- **Sampling Mode**—Sets the color sampling mode for a digital signal to either YCbCr 4: 4: 4, RGB or YCbCr 4: 2: 2. The proper sampling mode is determined automatically by the projector; you can override this setting.
- **Film Mode Detect**—Enables or disables film motion detection. This is only available for interlaced or segmented frame sources.
- **Chroma/luma Delay**—Affects any incoming composite or S-video signal, delaying the luma signal (intensity) in relation to the chroma (color). In the image, increasing the luma delay moves luma (seen as a shadow where colors overlap) to the right slightly, with colors remaining in place. Decreasing this delay moves the shadow slightly to the left. If necessary for your current source, adjust so that no shadows occur with adjacent colors.
- **Split Screen**—Allows a snapshot of the main image to be presented on the right side or lower part of the screen for evaluation of advanced image processing features. All resizing controls are honored on both images. However, image processing controls such as, Detail, Sharpness, Noise Reduction and Adaptive Contrast only happen on the left side or top image. Changing inputs, channels, or test patterns disables this control.

Split screen cannot be used in conjunction with either PIP or Tiling. Both PIP and Tiling must be disabled prior to enabling Split Screen control.

- **RGB Quantization Range**—Defines the RGB quantization levels for digital DVI and HDMI inputs using the RGB colors pace. Typically, graphics sources use the full range of levels for the given bit depth (such as 8-bit, 10-bit, 12-bit) and consumer electronics (CE) products typically use a limited range of data within the given bit depth. This control must be set to limited to correct the levels for those CE products that use the limited space. This adjusts what is considered black and white levels in the image; for example for an 8 bit space, full range RGB uses levels 0(black) to 255(white).

Manually optimize input levels

Because the projector automatically optimizes input levels for all but the most unusual of sources, Christie recommends only experienced users use the Input Levels submenu. Before beginning, check that overall contrast and brightness settings are near 50 and that color temperature is properly set up on an internal grey scale test pattern.

Good RGB or input levels—that is, the *drives* and *black levels* for each of the three colors, red, green and blue—ensure that images from analog sources other than decoded video have maximum contrast without crushing black or white. By default (and in an Auto Setup), the projector automatically determines the best input levels by monitoring image content and adjusting the controls appropriately. Further adjustment is typically not required to obtain proper blacks or whites. This automatic adjustment requires at least 6-12 consecutive white pixels in the image. Without these pixels, input levels may produce skewed colors, particularly in non-video images.

For a source exhibiting overly high black levels (typically caused by a noisy source causing black level spikes) use the **Input Levels** menu (shown above). These adjustments, serve as a calibration process compensating for differences in sources and cabling, to perfect the source image input levels and eliminate the overshoot and undershoot.

Input Levels are of limited use with digital signals, but do offer some ability to tweak poorly mastered source materials. Input levels apply for the current source only, but for any color temperature used. Assuming that color temperature has been set up based on the internal test patterns, you can then set up input levels for a given source so that it matches the color temperature of the internal test patterns.

- **Auto Input Level**—Compensates for incoming out-of-range drives (white) and black levels (black) that would cause crushing of light and dark colors in the image. After entering a check mark, wait for the six slide bar values to stabilize, then delete the check mark and exit. The Auto Input Level is automatically turned off upon exit from the Input Levels menu. Use only if you are an experienced user and you have an unusual source that you feel needs further color temperature and/or input level adjustment.
- **Black Levels And Drives**—Do not use Input Levels to adjust color temperature. This distorts contrast and brightness functions as well as color temperature.
 - a. Ensure overall Contrast and Brightness settings are both set to near 50.
Contrast = 50 (approx.) **Bright** = 50 (approx.)
This is not required for Auto adjustment.
 - b. Check the color temperature setup using an internal grey scale test pattern, making sure to obtain a neutral grey scale. This is not required for Auto adjustment.

- c. Confirm that you are using input on an Analog BNC card or a Dual Link DVI card. Input Levels are not applicable for sources going through the decoder. Christie recommends a grey scale.
 - d. If black levels are too high (and/or whites are too low, which is rare), you likely have a noisy source that is producing skewed input levels. Enable Auto in the **Input Levels** menu. Wait for all six values to stabilize. Alternatively, do not use Auto; reduce black levels manually instead. Judge by eye and change one or more of the six levels as necessary to obtain proper blacks and whites. You may want to see only a certain color while adjusting; use the **Auto Color Enable** option (described below).
 - e. Delete the Auto check mark and leave the Input Levels menu.
- **Auto Color Enable**—When a check mark is present, selecting a specific black level or drive to adjust automatically enables the corresponding color in the display. Delete the check mark to see all colors, or to enable a different specific color through the Color Enable control.
 - **Clamp Location**—Brightens the image produced from certain high-resolution high-frequency graphic sources. The projector automatically selects the best clamp location for most sources. Use the normal **Back Porch** location if the image is either sufficiently bright or overly bright. Select **Sync Tip** if the image appears unusually dim, if horizontal streaks are across the image, or if there is significant color drift. This moves the clamping pulse from the normal back porch location (which is likely too short) to the tip of the horizontal sync pulse. **Tri Level** is typically needed for an HDTV source.
 - **Input Peak Detector**—A tool to assist with defining individual input levels, enabling you to accurately set the Input Levels for any particular source with the appropriate image. Enabling the Peak Detector activates a special operating mode for detecting *only* pixels that are considered black or white—all other levels are displayed as a mid-level grey. When used with a smooth grey scale pattern in which black and white are known to be at opposite edges of the image, you can watch these isolated areas while adjusting individual black levels and input drives until both black and white edges are *just* visible and distinguished from neighboring pixels. Images from this source display correct blacks and whites without crushing.
 - a. Display a 16 level grey scale test pattern from the required external source and enter a check mark in the **Input Peak Detector** checkbox. The Input Peak Detector initially renders the grey scale as a uniform grey field before adjustment or extreme crushing.
 - b. Display one primary color. Select **Auto Color Enable** to ensure the correct color is displayed for each setting.
 - c. For the current color, adjust its corresponding **Black level** slide bar just until a single band of black appears at one edge of the screen. This band represents the first band of the grey scale pattern, which should be 100% black.
 - d. With the same color still active, adjust its corresponding **Input Drive** slide bar just until a single band of color appears at the opposite edge of the screen. This band represents the last band of the grey scale pattern, which should be 100% white (or the current color, if a certain color is enabled).
 - e. Check the black band and adjust the black level slide bar if necessary. Adjusting the black levels affects the gain. Only adjust when necessary.

- f. Repeat Steps c-d with the two remaining primary colors. When each primary color shows one optimized black band and white (or colored) band, the input levels for this source are correctly set. Upon exiting the **Input Levels** menu, the Peak Detector check box clears.
- **Color Enable**—Select which color or colors you want to see in the display, useful while working with color temperature white levels or input levels.

Correcting gamma settings

The system offers two types of gamma correction in **Image Settings > Advanced Image Settings > Gamma Settings**. Gamma correction can be applied to a specific source to correct for luma encoding. This is a channel setting and reapplied every time the same signal is detected. This is the Gamma control. On the other hand the system also provides a global **Gamma Correction** control. The global control offers an offset applied to all channels. This offset is used to compensate for changes in ambient conditions such as ambient light in the room and projected material.

- **Gamma**—Sets the base gamma table for a given source. Select from one of the standard tables, a custom gamma function, or select an arbitrary gamma table that has been downloaded to the projector. A separate PC utility is needed to do this.

The 2.22 curve is a power curve typically used to encode graphics and video sources. The standard curve (auto setup default) is a modified 2.22 curve with a small linear section in the black that enhances the detail in darker areas of the projected content.

Alternatively, if neither default is ideal, apply a simple gamma curve by defining a custom power function and slope. For more complex non-standard gamma curves, a user-defined curve created externally and downloaded to the projector can be used (requires separate PC-based Arbitrary Gamma software application to create the table and the Web UI to download it). If any of these special user curves have been installed, their names appear in the Gamma Table pull-down list.

Select **Gamma Function** from the list to enable the Gamma Function and Gamma Slope controls.

- **Gamma Correction**—Applies a global offset to all gamma settings for each channel. It affects the shape of the curve by performing a linear transform toward a gamma curve of 1.0 while the control is increasing and likewise a linear transform toward a gamma of 3.0 as the control is decreasing. The control should only be adjusted to compensate for ambient conditions. To correct a particular source only, use the **Gamma** control.
- **Gamma Function**—Defines the base gamma power curve used when the base gamma table value is set to **Gamma Function**. This value, combined with gamma slope setting determines the base gamma table used as the custom base table. The curve is generally a power curve with a small linear segment at the bottom defined by the slope.
- **Gamma Slope**—Defines a slope to be used for the base custom gamma table for a small section at the bottom of the curve. This slope brings in or out the low level blacks in the image.

Adjusting the sharpness of the image

Setting detail above the halfway-point can introduce noise in the image. Lower settings can improve a noisy signal. This command does not take effect unless the minimum change required in the **Detail Threshold** control is reached.

- **Texture Enhancement**—Applies texture detail enhancement based on adaptive horizontal, vertical, and diagonal large edge and small edge enhancement processes.
- **Detail Threshold**—Selects a filter sensitivity to noise. A higher value may improve noisy sources especially for higher settings of detail.
- **Detail Overshoot**—Minimizes ringing on the enhanced edges detail and texture effects.
- **Split Screen**—Allows a snap shot of the main image to be presented on the right side of the screen to allow evaluation of advanced image processing features. All resizing controls are honoured on both images; however, image processing controls only happen on the left side image. Changing inputs, channels or test patterns disable this control. PIP and Tiling operation must be disabled prior to enabling this control.

Selecting the noise reduction filter

Selects a filter sensitivity to noise. A higher value may improve noisy sources but it softens the image.

- **Block Artifact Reduction**—Locates and reduces block edges produced by discrete cosine transform (DCT) based compression processing.
- **Mosquito Noise Reduction**—Reduces mosquito artifacts around sharp edges in DCT based compression by dynamically adapting to image content.
- **Split Screen**—Allows a snapshot of the main image to be presented on the right side or lower part of the screen for evaluation of advanced image processing features. All resizing controls and input card features; such as color/tint for example, are honoured on both images. However; image processing controls such as the detail-texture, noise reduction and adaptive contrast features, only occur to the left side image. Changing inputs, channels, or test patterns disables this control.

Split screen cannot be used in conjunction with either PIP or Tiling. Both PIP and Tiling must be disabled prior to enabling Split Screen control.

- **Full Screen Eye-motion Filter**—Select this control to apply the Eye-Motion Filter to the entire screen, rather than applying just to the edge blending.
- **Eye-motion Filter**—Adjust the filter to reduce saccadic eye-motion artifacts, sometimes noticeable in edge blending regions. Too much filtering may result in loss of detail. For best results, adjust this setting while positioned at the nominal screen viewing distance.

Adjusting the color for the output

Select the output color adjustment most suited to this input signal. The options include the following:

- **Max Drives**—All color adjustments are turned off allowing the projector to run at maximum brightness.
- **Color Temperature**—Sets a color temperature between 3200 and 9300 based on the setting of the color temperature slide bar.

Expressed in degrees Kelvin [3200K, 5400K, and so on]. Lower numbers appear reddish white and higher numbers appear bluish.

Standard settings are:

- **9300K**, is close to the white of many computer monitors
- **6500K**, is the standard for color video, in both standard and high definition forms
- **5400K**, is a standard for graphics and black and white video
- **3200K**, is useful if the projected image is to be filmed or shot as part of a studio set illuminated with incandescent lights

For all color temperatures the color primaries; red, green, and blue are unchanged and reflect the native colors of the projector.

- **SD Video and HD Video**—Sets the output color to a specific standard value. Adjusts the colors; red, green, blue, and white.
- **User#**—Select 1 of 4 user defined sets of color adjustments. The sets are defined in the **Configuration** menu.

Selecting a color space

1. The current color space appears in the **Image Settings** menu.
2. Press **Enter** to select a different color space:
 - Select **RGB** unless you are using component video.
 - Select **YPbPr (Video)** with a standard definition televised signal (SDTV).
 - Select **YPbPr (HDTV)** with a high definition televised signal (HDTV).
3. When certain RGB signals are first connected, the projector may not recognize them as RGB and incorrectly decodes their color information as YPbPr (video). These signals can include:
 - RGB signals in NTSC, PAL, SECAM frequency ranges.
 - Scan-doubled sync-on-green.
 - Scan-quadrupled sync-on-green.

For these signals, change the color Space to RGB, and then define a new channel for future use.

Changing color performance

Changing a color performance or gamut is sometimes known as Comprehensive Color Adjustment™. Enter the known x/y coordinates from the chromaticity graph.

The factory-defined primary color levels, which ensure a specific color performance from projector-to-projector, can be calibrated in the Service menu only. The factory settings can be recovered by selecting **Service > Color Primary Settings > Reset to Factory Defaults?**

The projector can utilize any of the three pre-defined color performance settings identified at right (default = Max Drives), or colors can be driven on the basis of color temperature. For most applications, one of these gamuts produce accurate and realistic colors from a variety of sources. They can be applied at any time in the **Advanced Image Settings > Select Color Adjustment** and are not adjustable.

Defining user color gamuts

You may find the pre-defined color adjustment options do not suit your needs. For example, you may require a unique color gamut (range) for a single projector or application or you may need to precisely match colors across multiple adjacent displays.

1. In the **Color Adjustments by X,Y** or **Color Saturation** submenu Create, alter, or copy a color gamut (such as, color adjustment).

You can create up to four custom color gamuts (User 1, 2, 3, or 4) with these adjustments. The two menus differ only in their user interface, so use whichever menu best suits your needs and application. A color meter can help with adjustments.

2. Define the precise hue of each primary color component (red, green, blue, and white) used to generate the millions of colors produced in displays.
 3. Change either the x or y coordinates for each color to change the hue of the color, and relocate the triangle for possible colors. Keep new x, y coordinates within the original color gamut triangle shown here.
- For example, changing the x/y coordinates for red may move the color closer to orange or closer to violet, which in turn affects all displayed colors having a red component.
4. Adjust the slide bars or enter new specific coordinates as desired to define or change the color gamuts.
 5. Apply at any time in the **Advanced Image Settings** menu.

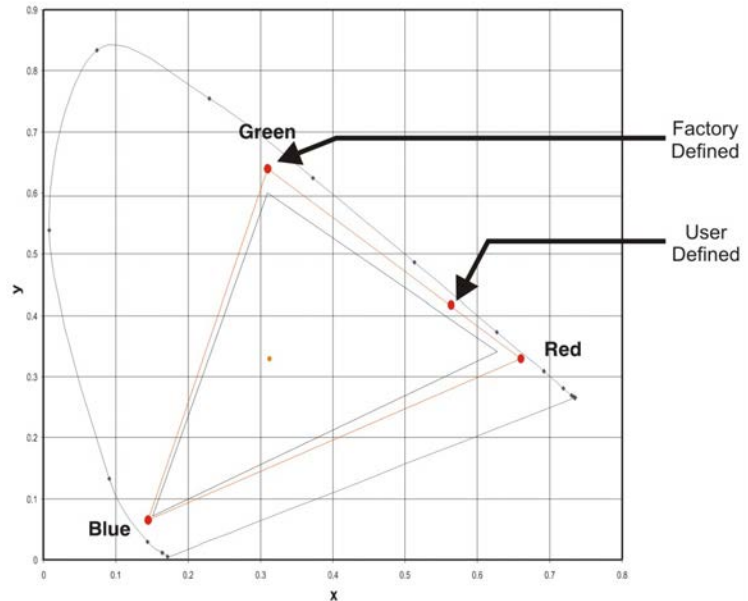

Adjusting the color saturation

Adjust color slide bars and judge image color by eye or meter. A user-defined color adjustment can be applied by selecting it in **Advanced Image Settings > Color Adjustment**.

Use this submenu if you do not have specific color coordinates in mind and judge color performance by eye or meter. Like the **Color Adjustment by X,Y** submenu, each color control actually defines new x/y coordinates for that color and changes its hue.

Adjust the hue of each primary color (red, green, blue, and white) by using more or less of it in relation to the other colors.

A **Color Saturation** adjustment defines the corresponding x/y coordinates shown in the **Color Adjustment by X,Y** submenu. These x/y coordinates remain stable for this User gamut until they are changed again through either menu. Values displayed in the **Color Saturation** menu fluctuate

as you use the projector, and is different when you return to this menu in the future. These floating changes do not affect the x/y coordinates or gamut.

Ensuring brightness uniformity

Provides further refinement of displays already matched for their primary colors and overall light output. Use Brightness Uniformity to create an exceptionally smooth image in which no area appears brighter than another.

When used to refine screens already matched for their primary colors, see [Matching colors across multiple screens](#) on page 73 and overall light output, proper adjustment of **Brightness Uniformity** can create an exceptionally smooth screen in which:

- No area of the screen appears more red, green or blue than another
- No area of the screen appears brighter than another
- Color and light output from one screen closely matches adjacent screens

Although the **Brightness Uniformity** control can be used for a stand-alone projector, it is particularly useful for setting up and maintaining tiled images that form a cohesive display wall in which the color cast and light output appear uniform throughout each image as well as throughout the entire wall. The procedure provided here assumes a multiple-screen application.

Before you begin, read through the entire procedure before attempting to adjust Brightness Uniformity controls, and keep in mind the following checklist of prerequisites and guidelines:

- **Adjust Colors First**—Always adjust the primary colors as described in [Matching colors across multiple screens](#) on page 73 procedure, before attempting to work with **Brightness Uniformity**. This ensures that primary colors, color temperature, and maximized light output are all well matched from one screen to another. These matches are needed before you can achieve good brightness uniformity results.
- **Run Lamp For 100 Hours**—Light output and brightness uniformity can vary significantly during the first 100 hours of lamp use. For best results with new lamps, either set up brightness uniformity after this period, or do an initial setup and re-check at 100 hours.
- **Set Lamp Power**—Ensure that each **Lamp Power** setting is as high as possible for your application while still maintaining a good overall match of light output from screen-to-screen. By nature, achieving a uniform brightness requires a slightly reduced overall brightness—this reduction helps ensure that you have enough range of adjustment when examining brightness variables more closely from screen-to-screen, and helps prevent premature maxing out when trying to match to a certain color, zone or projector.
- **Use A user Color Temperature**—Always adjust brightness uniformity for a User color temperature defined when you matched primary colors, and continue to use it for all sources displayed on the wall. Your other color temperatures are not necessarily matched from screen-to-screen.
- **White Uniformity Slide Bars**—**White Uniformity** slide bar values may not reduce to 0. Each slide bar adjusts overall light output in a specific screen zone, but the value shown represents the current setting for green in this zone. When other hidden values (red or blue) are lower than green, during adjustment in the **White Uniformity** menu their values reach 0 first, causing the slide bar to stop earlier than expected.
- **Judge By Eye Or Use A Meter**—Good brightness uniformity can be achieved with either.

In the Brightness Uniformity menu, select the **Brightness Uniformity Enable** checkbox to access a multitude of adjustments for light output control in specific areas throughout the image. Your settings apply as long as the **Brightness Uniformity Enable** checkbox is enabled. While making adjustments, enable the **Coarse Adjustment** checkbox to apply Brightness Uniformity settings with a large granularity. Coarse Adjustment helps identify brightness changes and accelerates projector response time while adjusting settings. To disable the Brightness Uniformity function, deselect the **Brightness Uniformity Enable** check mark.

1. Adjust primary colors see [Matching colors across multiple screens](#) on page 73 to ensure matched overall color temperatures and light output between screens.

Double-check that all WHITES and LIGHT OUTPUT are well-matched.

2. Enable the **Brightness Uniformity** checkbox. This enables access to the uniformity controls and applies the settings to your image.
3. Select the 13-Point test pattern for display. This pattern provides nine screen zones with 13 targets as shown.

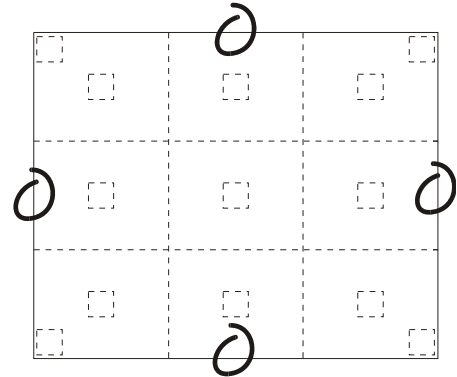

For best results, rather than examining the center of each zone when assessing Brightness Uniformity adjustments focus on extreme edges as indicated in the illustration at right.

- In either *Color Adjustments* menu, select a User color. Then:
 - If you have created a User 1 color gamut (recommended) for a well-matched wall, continue to Step 1e.
 - If you prefer maximum brightness rather than a particular color temperature, select **Max Drives**. Do not change User 1 Color Adjustment in color-matched applications.
4. In the **White Uniformity** menu, set the overall output level to **50.0** and all remaining slide bars to **0.0**. This decreases the light output just enough throughout the screen so that any color level can then be increased later as necessary for matching light output from zone-to-zone. Do not exceed **50.0** for Overall—a higher level likely interferes with achieving brightness uniformity and is not recommended.

Ensure that overall light output remains well matched from one screen center to the next. Where necessary, increase or decrease Lamp Power slightly to recover center matches.

5. On each screen, compare the color temperatures in the eight target zones (four edges and four corners) to that of the color temperature of the center. Compare using a white field only, and take note of any areas that do not match the center. Also decide if any screen exhibits a more obvious color shift than other screens—begin with this screen in Step 6.
6. Beginning with the screen that exhibits the most obvious color shift(s), for each edge that exhibits a noticeably different color temperature from the center, select the corresponding **Uniformity** adjustment menu—**Left, Right, Top** or **Bottom**.

For example, if any part of the left side is too blue, too red or too green, go to the **Left Uniformity** menu and adjust the colors, for example change their light output, until all portions of the left side closely match the center color temperature. Adjust an edge first (focusing on its center), and then adjust the corners.

Repeat the color adjustment of sides and corners for each edge of the screen that does not yet match the center (note that each corner is adjustable in either of its two adjacent side menus). When done, all areas of a given screen should match.

7. Repeat Steps 5 and 6 for all remaining screens.
8. For each screen, compare the light output of each edge and corner to that of the center. If any of the areas differ, use the **White Uniformity** menu to match edges and corners to the center as described below. Begin with the screen exhibiting the most obvious variations in light output.
 - a. Adjust **edge White Uniformity** first. Note each edge adjustment also affects the rest of the screen slightly. Keep all edges just slightly *lower* than the center light output rather than matching light output precisely. Otherwise, it may not be possible to brighten the corners (typically the dimmest areas of the screen) enough. The best uniformity is a compromise between the brightest and darkest areas of the screen.
 - b. Adjust **corner White Uniformity** last. Each corner adjustment affects only this quadrant.
 - c. Repeat for each screen.
9. Return to Steps 5 and 6 and, if necessary, fine-tune the zones so that they all still exhibit a single color temperature.

If you do not want to use or apply Brightness Uniformity settings, delete the check mark from the **Uniformity Enable** checkbox at the top of the Brightness Uniformity menu. Bottom defined by the slope.

Creating a seamless image with edge blending

Edge Blending provides a range of controls for smoothing together the overlapping bright edges of multiple adjacent projected images to create a single larger seamless image. These controls, which primarily affect white levels, are typically used in conjunction with mechanical lens blinders (optional), which are installed on the front of the projector and which primarily affect black levels.

Brightness uniformity adjustment, if desired, should be performed first. The **Edge Blend** or **Grid Test Pattern** is useful for the mechanical setup of the projectors. If necessary, adjust **Black Level Blending** first with the **Black** test pattern, then use the **White** test pattern to blend the white levels on the blend edges. The final step is to check the blended image with an external source. There is a center line (both horizontal and vertical) in the Edge Blending test pattern. The intersection of these lines is the true center of the projector's display area.

The **Show Blending Overlap** control enables or disables edge blending overlap. When enabled, this makes the size of the Edge Blending regions obvious. This control should only be used during setup.

In simple terms, a blend appears as a gradient strip along an edge of a projected image. It is darkest along the extreme edge of the image, and lightens nearer to the rest of the image (see right).

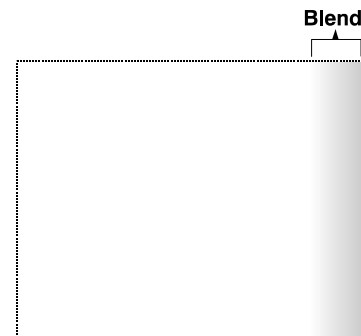

How are blends used?

In multiple-projector walls, complementary blends between neighboring images can compensate for the extra brightness or intensity where these edges overlap. By controlling blend width and other properties, you can achieve uniformity across the group of images. Visible overlaps disappears, as shown below.

For best results, use the same projector model and type throughout your display wall. In addition, avoid high-gain screens whenever possible—the optical performance of such screens demands minimal image offset, thus projectors must be located close to one another.

Use Edge Blending controls to set the precise *width*, *shape* and *midpoint* you need to blend overlapping edges together smoothly.

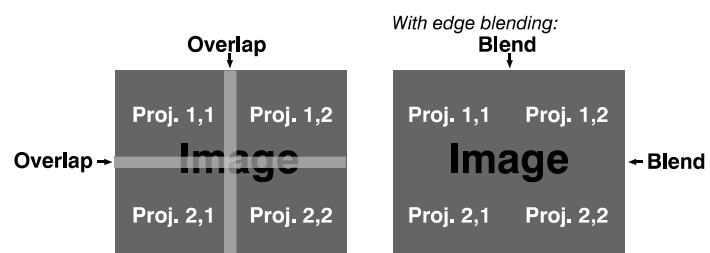

- **Blend Width**—Determines how much area is used for blending along an overlapping edge. Slide bar values represent the number of pixel steps used for the blend. For example, a setting of eight creates a blended edge eight pixels wide.

A setting of 0 signifies no blending. For best results in most applications, use a blend width greater than 10% of the resolution of the projector (192 on a 1920 x 1080 projector). Larger blend widths can mask uniformity issues between multiple projectors.

Ranges: (Projector number of columns / 2) horizontal, (projector number of lines / 2) vertical.

Example: $1920 / 2 = 960$ pixels horizontal, $1080 / 2 = 540$ pixels vertical.

- **Blend Shape**—Determines the rate of roll-off across the blend width, such as how quickly the white levels across the blend change from light and dark. Increasing the **Blend Shape** setting accelerates the rate of change at both extremes so that *less* of the region appears mid-grey (see image above). Decreasing the **Blend Shape** setting slows the rate of change so that *more* of the region appears mid-grey. For most applications, this subtle control is best left close to 50.
- **Blend Midpoint**—Determines the white level at the blend midpoint (the point equidistant between the beginning and end of the blend). Increasing the **Blend Midpoint** setting creates a blend that appears brighter than the rest of the image. Decreasing the **Blend Midpoint** setting creates a blend that is darker than the rest of the image. A setting of 50 means the midpoint is approximately 50% black—for best results in most applications, keep fairly close to this default.
- **Show Blending Overlap**—Turns your defined blend width area to solid grey so that, if needed, simply overlapping the grey bars can seamlessly align two adjacent images. Toggle the

Show Blending Overlap off to reactivate the blend effect. Blending Overlap appears as **Reserved** when Christie Twist is installed.



Notice. Failure to comply with the following may result in property damage.

- Christie recommends the projector units be the same models and have identical part numbers.
- Before attempting to work with edge blending software functions, align the projectors/images by correctly overlapping the displays from your intended external source.
- Match colors and the brightness uniformity.
- For a shared edge, all blend procedures and settings should be identical on both projectors

1. Start with two projectors.
2. Display the full white field test pattern from both.
3. Select **Configuration > Geometry and Color > Edge Blending**.
4. Enable **Edge Blending**.
5. Set starting points for adjustment:
 - a. Set all blend widths to 0.
 - b. Go to **More** and set everything in the **Edge Blending** menu to 50.
6. Set blend width on one projector, increase the **Blend Width** for an overlapping edge (for example, if the projector's image is on left, its right edge overlaps the adjacent image—adjust **Right Blend Width**). Use the same setting on the second projector for this shared edge.
7. Re-adjust the width on both projectors until the overly bright band at the midpoint of the overlapping blends disappears or changes to light grey. For the shared edge, use the same **Blend Width** setting on each projector. If the best blend appears to be between two settings, choose the wider setting for both projectors.
8. Check blend if the blended region appears too dark or light in relation to the rest of the image:
 - a. Increase **Blend Midpoint** in both projectors to lighten the overall blend, decrease to darken the overall blend.
 - b. Adjust **Blend Shape** in both projectors to fine-tune change the amount of mid-grey intensity (as opposed to black/white) in the blend.
9. Repeat with remaining projectors with overlaps.
10. Check completed display wall with the desired external signal.
11. If necessary, adjust the mechanical alignment to maintain perfect pixel-on-pixel alignment over time.

In applications where you are projecting only white or light images, the **Blend Width** may be slightly higher—set according to how much overlap you have between images. Use the following as a guide (examples show overlapping width only—values for overlapping height differs). The recommended overlap is 12.5% - 25%.

Adjusting the intensity of black

Eliminates the differences between black levels when edge blending multiple projectors. The **Black Level Blending** submenu provides many controls to allow the edges of adjacent images to be

smoothly overlapped creating a seamless image. Adjust white levels before adjusting black levels. Christie recommends using blinders for fixed installations.

Similar to **Edge Blending**, **Black Level Blending** allows you to adjust the black level intensity of multiple adjacent projected images to create one large seamless display.

Adjust white levels before adjusting black levels. The zones in the Black Level Blending (BLB) menu correspond to the edge blend zones.

1. Start with two projectors. Select the black test pattern for both projectors from the **Geometry and Color** submenu.
2. In the **Black Level Blending** submenu, enable black blending by selecting **Standard** from the pull-down list for each projector.
3. Working with one projector at a time, use the center brightness slide bar to adjust the center brightness (brightness of the non-blended region) so that the center intensity matches that of the brightest blended region (the center of all images when blending a 2 x 2 display is the target area).
4. You can choose which of the next four options, Top, Bottom, Left, and Right, to use depending on which edge of the projector you are working with has been edge blended. The blend width can be adjusted to line up properly but by default it corresponds to the edge blending setting determined for that edge.
5. The brightness and black hues of the blended region can be adjusted in more detail in case fine-tuning is needed (may be only necessary for blending a 2 x 2 projector display because of blending differs for the sides and center).

The menu options vary depending on the edge blending parameters. When adjusting six or more projectors, you need to ensure that the brightness of each target area is matched as closely as possible.

Uploading a gamma file

The projector must be powered on to enable the Upload list.

1. Click **Admin > System**.
2. To open the Choose file window, click **Upload Browse**.
3. Locate and select the file you want to upload from a Network drive location or from your hard drive.
4. Select **Gamma** as the file type.

If you select a Gamma file type, it must be a .csv file with 1024 values (all colors same) or 1024 x 3 for individual colors to enable the **Gamma Properties** section.

5. To display the Gamma Upload window, click **Upload**.
6. In the Display Name field, type a descriptive name.
7. To confirm the upload, click **Yes**.

Monitoring and Maintenance

Installers, service trained operators and all other users must maintain a safe operating environment at all times. Read through this section in its entirety and understand all warnings and precautions before attempting to operate this projector.

Backing up the projector configuration and preferences

Creating a backup file

1. Click **Admin > System**.
2. Select a file type (All, Preferences, Configuration, Channels, or Users) from the **Backup** list.
3. To initiate the download, click **Backup**.
A backup in progress bar appears. Once finished, a file download window appears.
4. Click **Save** to open a **Save As** window.
5. Locate and select a folder within your Network drive or hard drive where you want to save the file.
6. Click **Save**.

Restoring a backup file

1. Click **Admin > System**.
2. To open the Choose file window, click **Browse**.
3. Locate and select the file you want to restore.
4. Select the type of file to restore (All, Preferences, Configuration, Channels, Users or Real Time Events (RTE)).
Do not select All unless transferring all files from one projector to another or cloning.
5. To initiate the restore, click **Restore**.

A Restore in Progress bar appears. Once finished, a confirmation message appears.

Performing a diagnostic test using interrogator

1. Click **Admin > System**.
2. To initiate the diagnostic test and download the diagnostic test results to your computer, click **Interrogate**.

A Interrogator in Progress bar appears. Once the download is complete, a File Download window appears.

3. Click **Save**

The results can be saved to a Network drive or local hard-drive.

Monitoring the projector

Viewing the projector status

The read-only Status menu lists a variety of details about the standard and optional components currently detected in the projector. Refer to the Status menu for versions of hardware and software installed, the type (size) of lamp, the hours logged in total and for a specific period (such as a rental period), and for your projector model name and serial number. In addition, the Status menu identifies the current channel, its location, its frequencies and other details.

Alarm conditions

An alarm condition consists of a message that is on the LCD display located beside the built-in keypad.

Two types of alarm conditions exist:

- Warning Alarm
- Critical Alarm

A warning alarm is shown when an error or a non-optimal condition has occurred. That generally does not prevent the projector from operating. An example is when a temperature is slightly elevated.

A critical alarm is shown when a condition occurs that could prevent the projector from operating and could cause damage to the projector. This may cause the projector to shut down automatically. An example would be a fan not running.

Both alarm types display:

- The item of alarm
- The status of the item

The item of the alarm can be either physical, such as fan or sensor, or the alarm can be a software issue, such as lamp driver. The LCD displays the status of the item and its units; if applicable. If the

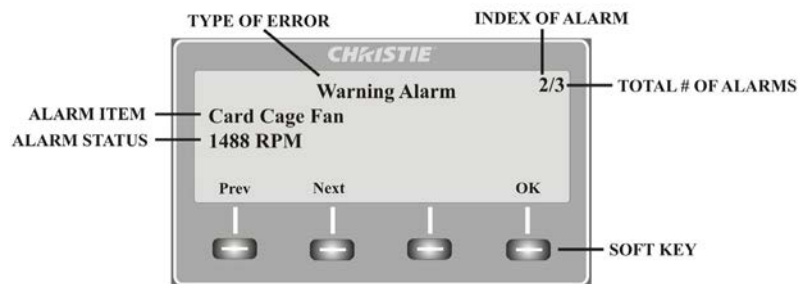

status of the item is out of normal range an alarm is created. When the status of the item is within normal range the alarm clears.

When an alarm is displayed in the LCD display, the built-in keypad is disabled. To confirm the alarm, press the OK soft key to enable the built-in keypad. The alarm condition can also be viewed using the remote in the read-only Status menu.

Configuring SNMP

The Mirage M Series SNMP (Simple Network Management Protocol) interface provides network administrators with a common way to manage their network devices from a single remote location. SNMP allows an administrator to query a number of devices to see their current status and configuration. It also allows operators to change configuration values and configure trap notifications to be sent when certain events occur.

The SNMP menu can be accessed from: **Configuration > Communications > SNMP**

Controls

Operators can request the current state of the following controls:

- Power
- Main Input
- Channel
- Lamp Life
- Shutter
- Host Name
- IP Address

Items

Operators can request the following status items directly:

- Main software version
- Global alarm status
- Lamp 1 life (just "Lamp Life" if there is no second lamp)
- Lamp 2 life (if applicable)
- Lamp 1 status (just "Lamp Life" if there is no second lamp)
- Lamp 2 status (if applicable)

Traps

A trap is a condition that SNMP monitors on the projector. When the condition is met, a notification is sent by an SNMP notification or email message. Each traps condition can be set to **Disabled**, **SNMP Trap**, **Email** or **SNMP Trap + Email**. The traps are defined in a series of MIB files hosted directly on the projector. MIB files can be accessed from a web browser window, using the address `//<IP Address>/mibs/.`

Operators can select from the following trap events to receive up to three SNMP traps and three email notifications when they occur:

Event	Message (email notification)	Parameters	Trap config. menu text	Default notification setting
Lamp end of life	Lamp has reached end of life	Lamp Number Lamp Hours Elapsed	Lamp Life	SNMP Trap + Email
Lamp end of life cleared	Lamp end of life cleared	Lamp Number		
Lamp fault	Lamp fault has occurred	Lamp Number Lamp Fault Description	Lamp Fault	
Lamp fault cleared	Lamp fault has been cleared	Lamp Number		
Fan stall	Fan stalled	Fan Name	Fan Stall	
Fan no longer stalled	Fan stall cleared			
Thermal sensor warning	Thermal sensor warning	Thermal Sensor Name	Thermal Sensors	Disabled
Thermal sensor error	Thermal sensor error	Thermal Sensor Text		
Thermal sensor OK	Thermal sensor OK			
Projector powered on (Standby to Lamps On)	Projector turned on (lamps on)	None	Power	
Projector powered off (Lamps On to Standby)	Projector turned off (lamps off)			
No video input signal	No video input signal	Frequency	Signal Lost/Detected	
Video input signal detected	Video input signal detected			
Lamp door open	Lamp door has been opened	Lamp Number	Lamp Door	
Lamp door closed	Lamp door has been closed			

Email notification

When a trap occurs while **Email Notification** is selected for the event, an individual email is sent to each user defined email recipient. The SNMP menu allows up to three email address (up to 64 characters in length) to request notifications from the system during a trap event.

The resulting email is in the following format:

From: <from@email.com>

To: <to@email.com>

Subject: Christie Mirage M Series Projector SNMP Notification

Message:

Projector Name: <projector name>

Location: <SNMP location>

IP Address: <IP address>

Description: <message>

Parameters: <param 1> = <param 1 value>; <param 2 > = <param 2 value>; ...

Adding a scheduled event

1. Click **Advanced** > **RTE**.

2. To open the RTE Wizard click **Add**.

3. Select the **Scheduled Event** tab.

The scheduled tab is always selected by default on add.

4. Select the frequency option for the event by selecting either **Once**, **Daily**, **Weekly**, or **Monthly**. End Date is enabled when Daily, Weekly or Monthly repeat options are selected.

5. Click within the **Start Time** field to open a calendar pop-up window.

6. Navigate to and choose a required date.

The selected date populates the Start Time field.

7. In the field below the Start Time field, enter a start time in the format "hr:min:sec".

The default is the current time.

8. To set the computer and projector time to be the same, click **Sync**; otherwise, the event runs based on the projector time.

9. Enter a description of the scheduled event, with a maximum of 100 characters.

10. Enter a serial command or a sequence of serial commands for the projector to perform in the Command String field.

- If a **GPIO** command string is needed, click **GPIO Output Helper** for instructions on how to create the command structure.

The Output field contains seven blocks which refer to the seven I/O pins on the GPIO connector. Pin 1 = +12V and Pin 5 = Ground. These are not included. Clicking a block toggles between H, L, and X. If the Pulse check box is selected, those I/O Pins defined pulse high or low. See [Connecting to the GPIO connector](#) on page 42 for detailed information. The Serial Representation box is read only.

- For a description of special RTE commands available for adding loops and delays to the command sequence click **Help**.
- To test the entered command string, click **Test**.

If the test passed or failed, a green or red icon appears to the right side of the Test button.

11. Click **Finish**.

The added event appears in the RTE Listing window. To activate or deactivate one or more RTEs, select or clear each check box in the Active column accordingly.

Adding a system event

1. Click **Advanced > RTE**.
2. To open the RTE wizard, click **Add**.
3. Select the **System Event** tab.
4. From the System Event list, select a type of event.

Adding a GPIO event

1. Click **Advanced > RTE**.
2. To open the RTE wizard, click **Add**.
3. Select the **GPIO Event** tab.
4. For the **GPIO Event** option define the Input Condition field as required.

The Input Condition field contains seven blocks which refer to the seven I/O pins on the GPIO connector. Pin 1 = +12V and Pin 5 = Ground are not included or changed. Clicking a block toggles between H, L, and X as shown. See [Connecting to the GPIO connector](#) on page 42 for detailed information.

Adding a function key event

1. Click **Advanced > RTE**.
2. Click **Add** to open the RTE Wizard.
3. Select the **Function Key Event** tab.
4. Select a **Function** key from the list.

LED and key states

The LED color of the keys indicates that the key is in one of these states:

LED color	Status
Amber	A functionality is available that affects the displayed image of the projector.
Blue	A functionality is available that is relevant to the built-in LCD only and will not affect the displayed image from the projector.
Off	The key is disabled in the current context.
Power key	Used to switch from Standby mode to ON, and from ON to Standby mode; LED always remains Amber

LED color	Status
Help key	Only available in the On Screen Display (OSD) context; LED is Amber when the menu is being displayed on the projected image display. When no menu is being displayed, the Help key is still enabled if the OSD is enabled. It is only disabled when the entire OSD is set to OFF.
Auto key	Enabled state when the power is ON, and there are no test patterns on the screen. If the power is OFF or a test pattern displays, the Auto key is disabled.
Exit key	Is determined in the specific context of the screen being displayed.
Input key	Enabled when the power is ON. Disabled if the power is OFF.
Lens key	Enabled when the power is ON. Disabled if the power is OFF.
Shutter key	Enabled when the power is ON. Disabled if the power is OFF.
Menu key	Always remains in the enabled state when the power is ON. If the power is off the Menu key is disabled.
Soft key	Used to select an action indicated by text above the key on the LCD. If no text is shown, the associated key is disabled.

Status LEDs

Looking from the back of the projector, the LEDs represent, from left to right; Lamp 1, Lamp 2, Power, and Status. The LEDs display the colors as shown below:

Projector states	LEDS	LED state
Hard Boot	All	All LEDs amber—means please wait
Standby Mode	Lamps 1 and 2	Off —lamps are off
	Power	Amber —AC is present but projector is off or standby
	Shutter	Green —shutter is open
		Amber —shutter is closed
Warm-up (Powering ON from standby)	All	LEDs cycle green from left to right
Normal Operation	Lamp 1 and 2	Amber —lamp time has expired and lamp should be replace
	Power	Green —projector is powered up and operating normally
	Shutter	Green —shutter is open
		Amber —shutter is closed
Cool-down	All	LEDS cycle from left to right
Error	Lamp 1 and 2	Amber —lamp time has expired and lamp should be replaced
		Flashing Red —lamp has expired and lamp should be replaced
	Power	Flashing Red —error has occurred. Details are display on the status display.

Projector states	LEDS	LED state
Software Upgrade in progress	All	The pattern will alternate between: Amber and Off
Lamp Regeneration in progress	Lamp 1 and 2	Flashing Green —the lamp is being switched off for its regeneration period to extend lamp life (typically 15 minutes every 24 hours)
	Power	Green —on Amber —standby
	Shutter	Green —shutter is open

Note: A condition occurs on the first power on after a software upgrade, and is indicated by all the following:

- The Status LEDES are cycling green.
- The LCD displays the warning Image Processor Upgrading.
- The LED on the Image Processor card flashes green.
- The web page shows a warning that the Image processor card is upgrading.
- When this occurs, the projector should not be AC power cycled and the Image Processor card should not be removed.

Maintaining the cooling system

The high-intensity lamps and electronics rely on a properly functioning cooling system. Regular maintenance of the cooling system is critical to prevent overheating and sudden projector failure and helps ensure reliable operation.

Ventilation

Vents and louvers in the projector covers provide ventilation, both for intake and exhaust. Never block or cover these openings. Do not install the projector near a radiator or heat register, or within an enclosure. To ensure adequate airflow around the projector, with a minimum clearance of 25cm (10") on the left, right and rear sides of the projector from any walls or other obstructions.



Caution! Failure to comply with the following could result in minor or moderate injury.

- Do not remove or disable the vane switch.
- Do not attempt to operate the product with inadequate airflow which can result in dangerous overheating.
- Keep fingers and other body parts away from the moving parts in the product. Tie back long hair, and remove jewelry and loose clothing before manually adjusting the product.



Notice. Failure to comply with the following may result in property damage.

- Use only high efficiency Christie approved filters.
- Do not reuse an old air filter.
- Do not operate the product without the filter installed.

Dust air filter

Check projector air dust filters, at minimum, every month.

Dust air filters (if fitted), should be replaced whenever the lamp is replaced or between 200-500 hours, depending on use. A clogged air filter reduces air flow and can lead to overheating and

failure of the projector. Check monthly by inspecting its color through the side vent grille with a flashlight. Replace grey colored filters.



Notice. Failure to comply with the following may result in property damage.

- Leave the filters in their sealed packaging until ready for use.

Replacing the air filter

1. Loosen the two captive screws at the top of each filter door. Allow the door to rest down and away from the projector.
2. Slide the air filter out and replace, vacuum or wash the filter. Wash using mild soap and water. Dry the filter before using.
3. Insert the new or cleaned air filter(s).
4. Secure the filter door by tightening the two captive screws loosened in Step 1.

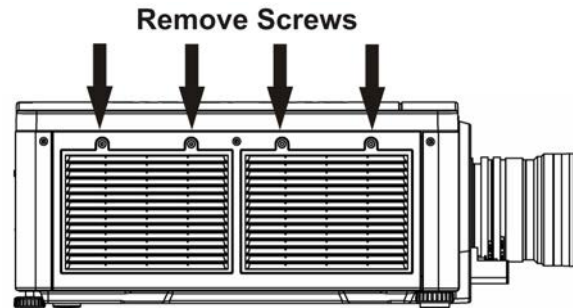

Replacing the fog filter

Fog filters should be replaced after each use of the projector to a maximum of 20 hours. The life of the filter is approximately 20 hours based on environmental conditions. Leave the filters in their sealed packaging until ready for use.



Notice. Failure to comply with the following may result in property damage.

- The fog filters cannot be re-used or they clog up with oil and the projector overheats and shuts down.
- Each filter is a two-stage filter; the black activated charcoal layer faces out, and the white layer faces the projector.

1. Unscrew the two captive screws at the top of each filter door. Allow the door to rest down, away from the projector.
2. Slide the filter (or dust air filter, if fitted) out.
3. Insert the new air fog filter with ensuring the white layer facing into the projector.
4. Secure the filter door by tightening the two captive screws loosened in Step 1.

Maintaining the optics

Viewing the lamp history

To display the serial number and the number of hours logged for each lamp (currently and previously) installed in the projector, select **Lamp > Lamp 1 History** or **Lamp > Lamp 2 History**. The top-most entry is always the most recent/current lamp.

Notifying users after a set number of hours of lamp use

When **Lamp > Warn when lamp reaches (hours)** is set, the projector presents a warning message when the lamp has a recorded on time that exceeds the specified number of hours. The warning is displayed on the status page for each lamp, where applicable. A value of 0 turns this feature off.

This setting is user-defined only. It has no bearing on lamp warranty and is not tied to actual lamp life in any way.

Replacing the lamps



Warning! Failure to comply with the following could result in death or serious injury.

- Never attempt to access the lamp while the lamp is ON. After turning the lamp OFF, it is crucial that you wait at least 10 minutes before handling the lamp. This provides sufficient time for the lamp cooling fans to properly cool the lamp.
- Handle lamps with extreme caution. Dispose of lamps according to safety regulations for your area.

1. Turn off the lamps using the remote keypad or the built-in keypad with the lamp **OFF** command (see Step 5) or by opening the lamp door.

The lamps turn off automatically when the lamp door is open.

2. To access the lamp compartment, use a #2 Phillips® screwdriver to turn the one captive screw on the lamp door counter-clockwise.

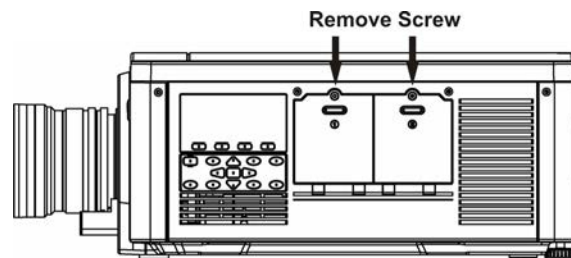

3. Wait at least 10 minutes before handling the lamps, to allow the lamps to cool.

4. Remove the old lamp.

- a. Loosen the three captive screws securing the lamp using a #1 Phillips® screwdriver.
- b. Carefully remove the lamp from the projector. Place the old lamp in a location where it cannot fall or be bumped.

5. To use lamp OFF command:

- a. In the lamp menu, select **Change Lamp**.
This prompts for the old lamp serial number (if it was not previously entered).
- b. Enter the new lamp serial number.

While this action is not mandatory, Christie recommends it for accurate lamp statistics to be archived.

6. Install the new lamp:

- a. Take precaution to align the new lamp properly in the correct orientation inside the projector.
- b. Press firmly to seat the lamps, ensuring the lamp is secure.

- c. Using the Phillips screwdriver and captive screws, secure the lamp door and tighten the captive screw.



Notice. Failure to comply with the following may result in property damage.

- If the lamps were turned off with the OFF command in step 1, they have to be manually turned on.
- If the lamps were turned off by opening the door, then they automatically turn on again when the door is closed.

Changing the lamp serial number

The **Lamp > Lamp 1 s/n** and **Lamp > Lamp 2 s/n** options allow the serial number for the current lamp to be changed. This applies the serial number to the current lamp statistics file. It does not archive the current statistics as done by the **Change Lamp** function.

Optical (excluding lens)

Unnecessary cleaning of optics, increases the risk of degrading delicate coatings and surfaces. Only clean optics when dust, dirt, oil, fingerprints or other marks are obvious and are causing performance problems. Maintenance of optical components requires a qualified service technician. Inspect exposed optical surfaces periodically in a clean, dust-free environment using a flashlight. Never touch an optical surface with your bare hands. Always wear latex lab gloves.

Supplies or cleaning optical surfaces

- Soft camel-hair brush
- Dust-free blower—filtered dry nitrogen blown through an anti-static nozzle.
- Dust-free lens tissue, such as Melles Griot Kodak tissues (18LAB020), Opto-wipes (18LAB022), Kim Wipes or equivalent
- **For lens only.** Lens cleaning solution, such as Melles Griot Optics Cleaning Fluid (18LAB011) or equivalent.
- Cotton swabs with wooden stems only
- Lens cleaning cloth/microfibre, such as Melles Griot (18LAB024) or equivalent

Clean the projection lens



- Clean only if necessary. A small amount of dust on the lens has little effect on picture quality.

Kits or items required

- Camel-hair brush
- Lint-free cloths (without color)
- Coated optics cleaning solution

dust from the projection lens

1. Brush most of the dust off with a camel-hair brush or use a dust-free blower.
2. Fold a microfiber cloth and wipe the remaining dust particles off the lens with the smooth portion of the cloth that has no folds or creases. Do not apply finger pressure. Instead, use the tension in the folded cloth to remove the dust.
3. If significant dust remains on the lens surface, dampen a clean microfiber cloth with lens cleaning solution and wipe gently until clean.

Removing fingerprints, smudges, or oil from the projection lens

1. Brush most of the dust off with a camelhair brush or use a dust-free blower.
2. Wrap a lens tissue around a swab and soak it in lens cleaning solution. The tissue should be damp but not dripping.
3. Gently wipe the surface using a figure eight motion.
4. Repeat until the blemish is removed. Clean the lens only if absolutely required.

Troubleshooting

If the projector is not operating properly, note the symptoms and use this section as a guide to resolve the problem. If the problem cannot be resolved, contact your dealer for assistance.



Warning! Failure to comply with the following could result in death or serious injury.

- A Christie qualified technician is required when opening an enclosure

Power

Learn more about resolving common power-related issues.

Projector does not power on

1. Ensure projector is plugged in. Check power switch above power cord is in the on position.
2. Check that the Status LEDs are on.

While the projector is busy initializing, the LEDs should be cycling. When finished initializing, the Power and Shutter LEDs (the two on the right) should be on.

3. Check the LCD display.

While the projector is busy initializing, the display should show "Please wait". When finished initializing, the display should show "Standby mode".

4. Check the LCD display for any warnings or errors.

A condition occurs on the first power on after a software upgrade, and is indicated by all the following:

- The Status LEDs are cycling green
- The LCD displays the warning "Image Processor Upgrading"
- The LED on the Image Processor card flashes green
- The Web page shows a warning that the Image processor card is upgrading.

When this occurs, the projector should not be AC power cycled and the Image Processor card should not be removed. This operation may take as long as five minutes to complete.

Lamp

Learn more about resolving common lamp-related issues.

Lamp does not ignite

1. Check for an interlock failure.
Check the LCD display for an error. If the other lamp has ignited and an image can be seen, use the remote keypad and check the Status menu for any errors and for the Lamp door interlock status. If not lamp has ignited, use the Virtual OSD on the web interface to check these items. The interlock failure could be an open lamp door or a failed lamp fan.
2. Using the remote keypad or Virtual OSD as above, check the lamp mode in the Lamp menu. This may be set to a single lamp or dual lamp mode. Check in the Status menu what the reported mode is.
3. For suspected communication failures, power-down the projector and try again.
4. If the lamp does not ignite after the second attempt and after powering down and up again (complete AC power down, then replace the lamp).

Lamp suddenly turns off

1. Check lamp power through the remote keypad checking the **Lamp** menu or from the web user interface **Advanced: Lamp** menu. Try increasing lamp power.
2. Check for an alarm condition on the LCD keypad display.
3. Replace the lamp.

Flicker, shadows or dimness

1. Check lamp power through the remote keypad checking the **Lamp** menu or from the web user interface **Advanced: Lamp** menu. Try increasing lamp power.
2. Replace the lamp.

LCD

Learn more about resolving common LCD-related issues.

Blank screen, no menu display

Press any arrow key on the built-in keypad. The backlight on the LCD and the backlight for the built-in keypad should turn on. If the LCD is still blank, restart the projector.

Remote keypad

Learn more about resolving common remote keypad-related issues.

Remote keypad does not seem to work

1. Replace the batteries.
2. Check if IR signals are received by the projector. Pressing any key on the remote control towards the front or rear sensor, the Status LED blinks, regardless if any command is executed. If the LED does not blink, restart the projector.
3. Ensure the remote keypad is enabled. If the projector is powered, using the built-in keypad, open the on-screen display menu and go to the **Main Menu > Configuration > Communication** submenu and check the checkboxes for **Front IR Enabled** and **Rear IR Enabled** are enabled. Enable them if they were disabled and try again.
4. Projector is busy. If the projector is busy in a warm-up mode or in a cool-down mode, the commands from the remote keypad may be ignored. Wait until the projector reaches a stable state (Power On or Stand By) and try again.
5. Press the **PROJ** key on the remote keypad. If this brings up a popup box on the on-screen display, ensure that the checkbox is marked to enable the projector.
6. Using the XLR connector, use the remote as a wired keypad. If it does work and all the IR sensors have been enabled, there may be a problem with the IR sensors.

On-screen display

Learn more about resolving common on-screen display-related issues.

The on-screen display menu does not display

- Using the LCD, ensure that on-screen display menu is enabled, scroll until the item on-screen display appears. The LCD shows "OSD: off". Press and hold the OSD soft key on the built-in keypad. The LCD now shows "OSD on" then press the menu key on the remote keypad.
or
- Press and hold the OSD key on the remote keypad for 2-3 seconds, then press the menu key.

Ethernet

Learn more about resolving common Ethernet-related issues.

Cannot establish communication with projector

1. Ensure any address changes have been saved, and reboot to implement. If you still cannot establish communications with a projector added to an existing Ethernet network, the projector

IP address is likely in conflict with another address already in use. Contact your network administrator.

2. Ensure Ethernet settings are valid for the site. All devices should have the same subnet mask yet unique IP addresses.

Display

Learn more about resolving common display-related issues.

The projector is on but there is no display

1. Was a lens cover accidentally left on? Remove the lens cover.
2. On the LCD display, check that the shutter is open. This is also indicated by the shutter LED being green.
3. Is the correct input selected? Check the cable connections.
4. Check if menus appear on the screen.
5. Can you access test pattern? Ensure a full black test pattern has not been selected for display, press **Menu** to access test patterns, then cycle patterns with keys. Check your source connections again.

Severe motion artifacts

1. Most likely a synchronization problem has occurred with reversed 3-2 pull-down in 60Hz-to-24Hz film-to-digital conversion in your source. Correct at the source.
2. Set the projector to run in Free run. Open the **OSD** menu and go to **Input Switching** and **PIP**. Ensure Running mode is set to **Free Run** not to **Frame Lock**.
3. Display a test pattern on the screen, pressing **Test** on the remote keypad. The test pattern should be displayed correctly. If not, contact your dealer for assistance.

Image appears squeezed or vertically stretched into center of screen

1. To run auto setup, press **Auto** on the remote keypad.
2. Check your resizing selection.

The display is jittery or unstable

1. If the display is jittery or blinking erratically, ensure the source is properly connected and of adequate quality for detection. With a poor quality or improperly connected source, the projector repeatedly attempts to display an image, however briefly.

2. The horizontal and vertical scan frequency of the input signal may be out of range for the projector. For scan frequency ranges, see [Specifications](#) on page 126.
3. The sync signal may be inadequate. Correct the problem at the source.

The display is faint

1. Brightness, contrast, and/or gamma may be set incorrectly.
2. The source may be double terminated. Ensure the source is terminated only once.
3. The source (if non-video) may need a different sync tip clamp location.

The upper portion of the display is waving, tearing or jittering

1. This can occur with video or VCR sources. Check your source.

Portions of the display are cut off or warped to the opposite edge

1. Resizing may need adjustment. Adjust until the entire image is visible and centered.

Display appears compressed (vertically stretched)

1. The frequency of the pixel sampling clock is incorrect for the current source.
2. Sizing and positioning options may be adjusted poorly for the incoming source signal.
3. Use an anamorphic lens for typical HDTV and anamorphic DVD sources that have been re-sized and vertically stretched, through third-party software.

Data is cropped from edges

1. To display the missing material, reduce the image size to fill the display area available in the projector, then stretch vertically to fill the screen from top to bottom.
2. Add the anamorphic lens to regain image width.

Display quality appears to drift from good-to-bad, bad-to-good

1. The source input signal may be of low quality.
2. The horizontal or vertical frequency of the input may have changed at the source end.

Display suddenly freezes

If the screen blacks out inexplicably, excessive voltage noise on the AC or ground input may have interrupted the projector's ability to lock on to a signal.

1. Power down the projector and disconnect from AC.
2. Plug in the projector and power up as usual.

Colors in the display are inaccurate

1. The color, tint, color space, and/or color temperature settings may require adjustment at your input source.
2. Try **Auto Setup**.
3. Ensure signal connections are correct.
4. Ensure the proper channel for this source is being used.

Display is not rectangular

1. Check leveling of the projector. Ensure the lens surface and screen are parallel to one another.
2. Is the vertical offset correct? Make the necessary adjustments to the vertical offset on the lens mount.

Display is noisy

1. Display adjustment at the input source may be required. Adjust pixel tracking, phase and filter. Noise is particularly common on YPbPr signals from a DVD player.
2. Ensure the video input is terminated (75 ohms). If it is the last connection in a loop-through chain, the video input should be terminated at the last source input only.
3. The input signal and/or signal cables carrying the input signal may be of poor quality.
4. If the distance between the input source device and the projector is greater than 25 feet, signal amplification/conditioning may be required.
5. If the source is a VCR or off-air broadcast, detail may be set too high.

Web interface

Learn more about resolving common web interface-related issues.

After a projector software upgrade, the web pages do not display correctly

After an upgrade, the temporary internet files and cookies must be cleared from the web browser to ensure that web UI changes can take effect.

1. Using the Internet Explorer menu bar, select **Tools > Internet Options**.
2. From the **Browsing History** option, click **Delete**.
3. Click **Delete files**.
4. Once the Delete Files window displays, click **Yes**.
5. Click **Delete cookies**.
6. Once the Delete Cookies window displays, click **Yes**.
7. Click **Close**.
8. To close the **Internet Options** window, click **OK**.
9. Close the browser and re-open before connecting to the projector.

A backup or interrogator file cannot be saved

After performing a backup of Interrogator, you may be prompted before saving the file. If you have not specifically set Internet Explorer to automatically open/save the file without prompting, and if popup windows have been disabled (by enabling the popup blocker), you cannot save the file.

1. Disable the popup blocker from **Main > Tools > Pop-up Blocker**.

Different types of tool bars have the potential to block pop-ups.

or

1. To open the Internet Options window, using the Internet Explorer menu bar, select **Tools > Internet Options**.



2. Select **Internet**.

- To open the Security Settings-Internet Zone window, click **Custom Level**.

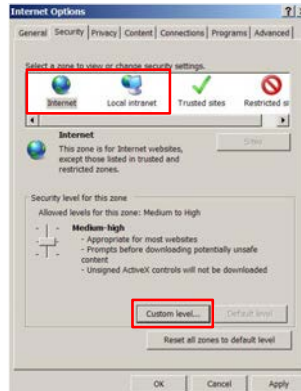

- Scroll the list until you see the Downloads option setting.
- Ensure the **Automatic prompting for file downloads** and **File Download** options are selected.

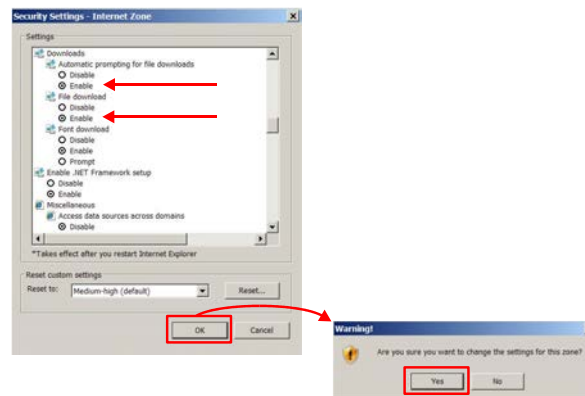

- Click **OK**.
- At the Warning prompt, click **OK**.
- Using the Internet Option window, select **Local intranet**.
- Click **Custom Level**.
- Repeat steps 4 to 9.

Specifications

This section provides detailed projector specifications. Due to continuing research, detailed features are subject to change without notice.

Pixel format

1080p (H x V square pixels)	1920 x 1080
SXGA+ (H x V square pixels)	1400 x 1050
WUXGA (H x V square pixels)	1920 x 1200

Contrast

ANSI: 16 pt. checker pattern on black screen	650:1 typical
Full field: 9 pt. average ON/OFF with background light subtraction	2500:1 typical (full open aperture) 1080p 2100:1 typical (full open aperture) SXGA+ 2100:1 typical (full open aperture) WUXGA

Gamma

Default Gamma (all points from 10 to 90 IRE)	2.2 + linear segment
Adjustable Gamma range	1.0 to 3.0

Grayscale/color resolution

Resolution	10 bits (non-linear) minimum (gamma encoded)
------------	--

Color temperature

White Default CCT (without YNF)	7700 K \pm 2000 K 350 W, 450 W lamp
White YNF CCT (with YNF activation, electronically corrected)	6500 K \pm 1000 K
Range of adjustment	3200 K - 9300 K
Tracking (deviation from normal over full range from 10 to 100 IRE)	\pm 500 K maximum
Stability (during rated lamp life)	\pm 500 K maximum

Input source signal compatibility

Analog-only input

Connectors	five female BNC, 75 Ohm R/Pr G/Y B/Pb H/C V
Color spaces/signal types	RGB YPbPr
A/D conversion	10 bits

Twin HDMI input

Connectors	Two independent HDMI inputs type A Two loop-out connectors type A
Color spaces/signal types	RGB YCbCr (4:2:2) YCbCr (4:4:4) HDCP support HDMI 1.3 supported (not including audio) except: 12-bit color dithered to 10 bits; 16 bit color not supported

Dual Link DVI Input

Connectors	One dual link DVI-I One analog 15-pin VGA
Color spaces/signal types	HDCP support

A/D conversion	10 bits for single link DVI input 8 bits for dual link DVI inputs
Frequency	165 Megapixels/s analog

Video Decoder input

Connectors	Two S-Video 4-pin miniature DIN Four BNC, 75 Ohm Two independent decoder channels for PIP
Color spaces/signal types	Composite video Component video (SD and ED only) S-video
A/D conversion	10 bits
Video Standards	NTSC, NTSC 4.43, PAL, PAL M, PAL N, PAL 60, SECAM

Dual 3G/HD/SD-SDI

Connectors	BNC, 75 Ohm
Color spaces/signal types	Dual HD input SDI, HD-SDI, 3G-SDI

DisplayPort input

Connectors	Two independent DisplayPort inputs Two loop-out DisplayPort connectors
Color spaces/signal types	RGB YCbCr (4:2:2) YCbCr (4:4:4) HDCP support on inputs DisplayPort 1.1a supported (not including audio)

Power requirements

Rated voltage	100 VAC to 240 VAC
Rated current (dual lamp operation)	
450 W 1080p/SXGA+/WUXGA	15 A @ 100 VAC
370 W 1080p/SXGA+/WUXGA	12 A @ 100 VAC
Line frequency	50/60 Hz
AC input coupler	15 A, 250 VAC
Type of connector	IEC 320-C14 with wire cable clamp

Line cord	14AWG type FT1 with plug, NEMA 5-15P, 15A
Inrush current	60 A max
Maximum power consumption	Dual Lamp
1080p/SXGA+/WUXGA	1500 W (dual lamp)/750 W (single lamp)
1080p/SXGA+/WUXGA	1320 W (dual lamp)/831 W (single lamp)
1080p/SXGA+/WUXGA	1267 W (dual lamp)/805 W (single lamp)
1080p/SXGA+/WUXGA	1135 W (dual lamp)/739 W (single lamp)
1080p/SXGA+/WUXGA	871 W (dual lamp)/607 W (single lamp)
1080p/SXGA+/WUXGA	739 W (dual lamp)/541 W (single lamp)

Physical specifications

Size

Maximum product dimensions (L x W x H) (with lens removed)	561 x 500 x 247 mm 22.1 x 19.7 x 9.75 inches
Maximum shipping dimensions (L x W x H)	775 x 698.5 x 584 mm 30.5 x 27.5 x 23 inches

Weight

Maximum product weight (with lens removed)	25 kg (55 lbs)
Maximum shipping weight (includes packaging)	40 kg (87 lbs)

Environment

Temperature/humidity/altitude

Operating temperature range	5 to 40°C (41 to 104°F)
Storage temperature range	-40 to 70°C
Humidity range	10% to 80%, non condensing
Operating altitude	10,000 ft. maximum

Regulatory

Safety

- CAN/CSA C22.2 No. 60950-1
- UL 60950-1
- IEC 60950-1
- EN60950

Electro-magnetic compatibility

Emissions

- FCC CFR47, Part 15, Subpart B, Class A - Unintentional Radiators
- CISPR 22/EN55022 Class A - Information Technology Equipment

Immunity

- CISPR 24/EN55024 Class A - Information Technology Equipment

Environmental

The product must conform to:

- EU Directive (2011/65/EU) on the restriction of the use of certain hazardous substances (RoHS) in electrical and electronic equipment and the applicable official amendment(s).
- EU Regulation (EC) No. 1907/2006 on the registration, evaluation, authorization and restriction of chemicals (REACH) and the applicable official amendments.
- EU Directive (2012/19/EU) on waste and electrical and electronic equipment (WEEE) and the applicable official amendment(s).
- China Ministry of Information Industry Order No.39 (02/2006) on the control of pollution caused by electronic information products, the hazardous substances concentration limits (SJ/T11363-2006), and the applicable product marking requirement (SJ/T11364-2006).

Marking

This product shall conform to all relevant Canadian, US, and European directives, standards, safety, health and environmental concerns and bare the following markings at product launch:

- UL
- CE
- RoHS
- WEEE
- Future International Certifications to include: CCC, KC, PSE, c-tick, CU, South Africa, Saudi Arabia, and India

International packaging recycling mark requirements:

- EU Directive (2002/96/EC) on waste and electrical and electronic equipment (WEEE);
- EU Directive (94/62/EC) on packaging and packaging waste;

China packaging recycling mark standard (GB18455-2001).

Appendix: DMX/ArtNET

DMX and real time events

DMX is a standard for digital communication networks that are commonly used to control stage lighting and effects.

A real time event is a pre-recorded sequence of one or more serial commands which are executed when a defined trigger occurs. For example:

- A trigger can be timed based (such as Saturday at 1:00pm; occurring every other week)
- A trigger can be event based (such as System powers on, good signal, and so on)
- A trigger can be a number of other events

A real time event can use nested loops and delays. Only statically defined commands can be executed (such as PWR 0, SHU 1). You cannot use variables or other complex programming techniques.

Lens control limitations

Normal ILS control of the lens horizontal and vertical positions by the projector respects the boundaries of the lens keep out area. This area is necessary to prevent damage to components within the projector. When the DMX controls are used to set the absolute position of the lens, setting values in these keep out areas may result in an unwanted final lens position. You must ensure that any interim or final lens positions, at any time during the lens movement, do not enter the keep out area.

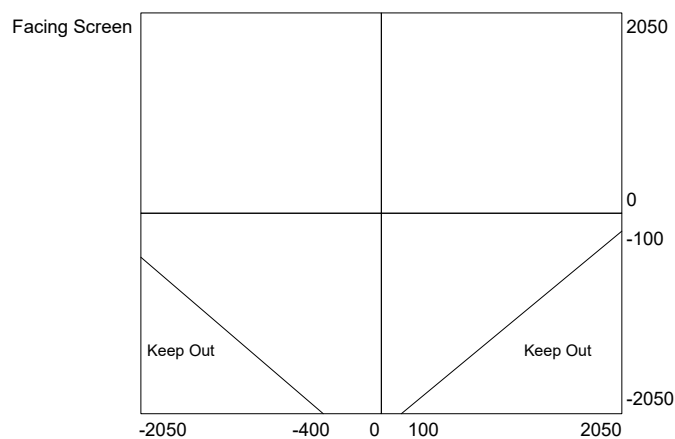

DMX channel setup

Each personality has a different number of channels:

- Setup Personality—38 channels
- Show Personality—18 channels
- Nitro VIP Projector Yoke Personality—25 channels

You must properly configure the base channel (depending on which personality is used) correctly. While the DMX specification allows for device overlapping, this may cause unexpected results. Below is a table of how projectors should be configured (assuming all projectors are to be controlled independently and use the same personality):

Show personality (correct)

Base channel	All projectors using Show Personality (correct)
1	Projector 1 (18 channel)
19	Projector 2 (18 channel)
37	Projector 3 (18 channel)

Setup personality (correct)

Base channel	All projectors using Show Personality (correct)
1	Projector 1 (38 channel)
39	Projector 2 (38 channel)
77	Projector 3 (38 channel)

Show personality (incorrect)

Base channel	All projectors using Show Personality (correct)
1	Projector 1 (18 channel)
1	Projector 2 (18 channel)
12	Projector 3 (18 channel)

Mirage M Series setup personality

Channel	Group	Name	Description	Notes
1	Safety	Slider Lock	0 to 171 = Locked 172 to 255 = Unlocked	No Channel changes are applied when this control is locked. Channel changes made while the slider is locked are applied once the slider becomes unlocked.
2	Video	Fade to/from Black	0 to 85 = Black screen (picture mute on) 172 to 255 = Live video (picture mute off) 255 = Default	To manually control the fade to black time, use the brightness channel to achieve the same effect.
3	Lens	Shutter	0 to 85 = Shutter closed (black screen) 172 to 255 = Shutter open (live video) 255 = Default	
4	Lens	Lens shift enable	0 to 85 = Lens shift disable 172 to 255 = Lens shift enable 255 = Default	Locks all lens motors.
5	Lens	Zoom (coarse)	0 to 255 = Scaled as percentage of total control range, which is 0 to 2100	Locked by channel Lens shift enable.
6	Lens	Zoom (fine)	128 = Default (coarse) 0 = Default (fine)	
7	Lens	Zoom (coarse)	0 to 255 = Scaled as % of total control range, which is 0 to 2100	Locked by channel Lens shift enable.
8	Lens	Zoom (fine)	128 = Default (coarse) 0 = Default (fine)	
9	Lens	Lens Horizontal position (coarse)	0 to 255 = Scaled as percentage of total control range, which is 0 to 4096 128 = Default (coarse)	Locked by channel Lens shift enable
10	Lens	Lens Horizontal position (fine)	0 = Default (fine)	
11	Lens	Lens Vertical position (coarse)	0 to 255 = Scaled as percentage of total control range, which is 0 to 4096 128 = Default (coarse)	Locked by channel Lens shift enable
12	Lens	Lens Vertical position (fine)	0 = Default (fine)	

Channel	Group	Name	Description	Notes
13	Input	Channel	<p>Projector channel selection</p> <p>0 to 9 = Projector channel 1</p> <p>10 to 19 = Projector channel 2</p> <p>20 to 29 = Projector channel 3</p> <p>—</p> <p>180 to 189 = Projector channel 19</p> <p>190 to 199 = Projector channel 20</p> <p>255 = Default</p>	
14	Input	Input	<p>Input selection</p> <p>0 to 9 = Slot 1, input 1</p> <p>10 to 19 = Slot 1, input 2</p> <p>—</p> <p>50 to 59 = Slot 1, input 6</p> <p>60 to 69 = Slot 2, input 1</p> <p>—</p> <p>110 to 119 = Slot 2, input 6</p> <p>120 to 129 = Slot 3, input 1</p> <p>—</p> <p>170 to 179 = Slot 3, input 6</p> <p>180 to 189 = Slot 4, input 1</p> <p>—</p> <p>230 to 239 = Slot 4, input 6</p> <p>255 = Default</p>	Does not change input on default.
15	Image	Image Freeze	<p>0 to 85 = Unfreeze image</p> <p>172 to 255 = Freeze Image</p> <p>0 = Default</p>	
16	Lamps/ Power	Power	<p>0 to 85 = Power off (switch lamps off, cool lamps down and go to Standby mode)</p> <p>172 to 255 = Power on (switch lamps on, warm up mode)</p> <p>128 = Default</p>	<p>A five second timer is used before executing a power state change. If the slider moves out of the On/Off range within the five seconds, the timer is cancelled.</p> <p>Does not change power state on default.</p>
17	Image	Size	<p>0 to 255 = Scaled as percentage of total control range, which is 200 to 4000</p> <p>67 = Default</p>	
18	Image	Vertical Stretch	<p>0 to 255 = Scaled as percentage of total control range, which is 200 to 3000</p> <p>91 = Default</p>	

Channel	Group	Name	Description	Notes
19	Setup Functions	Projector Orientation	0 to 49 = Front projection 50 to 99 = Rear projection 100 to 149 = Front projection inverted 150 to 199 = Rear projection inverted 255 = Default	Does not change projector orientation on default.
20	Setup Functions	On Screen Display	0 to 85 = On-screen display off 172 to 255 = On-screen display on 128 = Default	Does not change the on-screen display on default.
21	Setup Functions	Lens Calibrate	172 to 255 = Run calibration 0 = Default	Locked by channel Lens shift enable
22	Setup Functions	Lamp Power	Scaled as percentage of total control range. Examples are given for 350 W lamps: 0 = 0% 300 W — 127 = 50% 335 W — 255 = 100% 370 W (Default)	Depends on what lamps are used, power rating may be different scale.
23	Setup Functions	Lamp Mode	0 to 85 = Auto select single lamp 172 to 255 = Dual lamp mode 128 = Default	Does not change lamp mode on default.
24	Setup Functions	Test Pattern	0 to 19 = Off 20 to 39 = Grid 40 to 59 = Grey Scale 16 60 to 79 = White 80 to 99 = Flat Grey 100 to 119 = Black 120 to 139 = Checker 140 to 159 = 13 Point 160 to 179 = Color Bars 180 to 199 = Aspect Ratio 200 to 219 = Edge Blend 220 to 239 = Boresight 0 = Default	
25	Colormetry	Brightness	0 to 255 = Scaled as percentage of total control range, which is 0 to 100 128 = Default	
26	Colormetry	Contrast	0 to 255 = Scaled as percentage of total control range, which is 0 to 100 128 = Default	

Channel	Group	Name	Description	Notes
27	Colormetry	Gamma	0 to 255 = Scaled as percentage of total control range, which is -100 to 100 128 = Default	
28	Colormetry	Color Space	0 to 49 = RGB 50 to 99 = YCbCr SDTV (ITU-R BT.601) 100 to 149 = YCbCr HDTV (ITU-R BT.7090 = Default	
29	Colormetry	Output Color	0 to 19 = Max drivers 20 to 39 = Color temperature (enables 31) 40 to 59 = SD video 60 to 79 = HD video 80 to 99 = User setting 1 100 to 119 = User setting 2 120 to 139 = User setting 3 140 to 159 = User setting 4 0 = Default	
30	Colormetry	Color Purity Filter	0 to 85 = CPF off 172 to 255 = CPF on 0 = Default	This is the global CPF control, not the channel control.
31	Colormetry	Interpolated Color (Temperature)	0 to 255 = Scaled as percentage of total control range, which is 3200 to 9300 128 = Default	Output Color control must be set to Color Temperature in DMX channel 29
32	Advanced Image	Blend enable	0 to 19 = Blend disable 20 to 39 = Standard blend enable 40 to 59 = User Blend 1 enable 60 to 79 = User Blend 2 enable — 220-239 = User Blend 10 enable 0 = Default	The list of blends depends on the blends having been saved on the projector by the user.
33	Advanced Image	Warp/keystone enable	0 to 19 = Warp/keystone disable 20 to 39 = 2D Keystone enable 40 to 59 = Warp 1 enable — 220 to 239 = Warp 10 enable 0 = Default	The list of warps depends on the warps saved on the projector by the user.
34	Real Time Events	RTE 1	0 to 85 = Cancel current running RTE 172 to 255 = Triggers RTE 1 128 = Default	

Channel	Group	Name	Description	Notes
35	Real Time Events	RTE 2	0 to 85 = Cancel current running RTE 172 to 255 = Triggers RTE 2 128 = Default	
36	Real Time Events	RTE 3	0 to 85 = Cancel current running RTE 172 to 255 = Triggers RTE 3 128 = Default	
37	Reserved		Reserved for future expansion	No reset
38	Reserved		Reserved for future expansion	No reset

Mirage M Series show personality

Channel	Group	Name	Description	Notes
1	Safety	Slider Lock	0 to 171 = Locked 172 to 255 = Unlocked 255 = Default	No channel changes are applied when this control is locked. Channel changes made while the slider is locked are applied once the slider becomes unlocked.
2	Video	Fade to/from Black	0 to 85 = Black screen (Picture mute on) 172 to 255 = Live video (Picture mute off) 255 = Default	To manually control the fade to black time, use the brightness channel to achieve the same effect.
3	Lens	Shutter	0 to 85 = Shutter closed (Black screen) 172 to 255 = Shutter open (Live video) 255 = Default	
4	Lens	Lens shift enable	0 to 85 = Lens shift disable 172 to 255 = Lens shift enable 255 = Default	Lock all lens motors.
5	Lens	Zoom (coarse)	0 to 255 Scaled as percentage of total control range, which is 0 to 2100 128 = Default (coarse) 0 = Default (fine)	Locked by channel Lens shift enable
6	Lens	Zoom (fine)		
7	Lens	Focus (coarse)	0 to 255 Scaled as percentage of total control range, which is 0 to 2100 128 = Default (coarse) 0 = Default (fine)	Locked by channel Lens shift enable
8	Lens	Focus (fine)		
9	Lens	Lens Horizontal position (coarse)	0 to 255 = Scaled as percentage of total control range, which is 0 to 4096 128 = Default (coarse) 0 = Default (fine)	Locked by channel Lens shift enable
10	Lens	Lens Horizontal position (fine)		
11	Lens	Lens Vertical position (coarse)	0 to 255 = Scaled as percentage of total control range, which is 0 to 4096 128 = Default (coarse) 0 = Default (fine)	Locked by channel Lens shift enable
12	Lens	Lens Vertical position (fine)		

Channel	Group	Name	Description	Notes
13	Input	Channel	Projector channel selection 0 to 9 = Projector channel 1 10 to 19 = Projector channel 2 20 to 29 = Projector channel 3 180 to 189 = Projector channel 19 190 to 199 = Projector channel 20 255 = Default	
14	Input	Input	Input selection 0 to 9 = Slot 1, input 1 10 to 19 = Slot 1, input 2 50 to 59 = Slot 1, input 6 60 to 69 = Slot 2, input 1 110 to 119 = Slot 2, input 6 120 to 129 = Slot 3, input 1 170 to 179 = Slot 3, input 6 180 to 189 = Slot 4, input 1 230 to 239 = Slot 4, input 6 255 = Default	Does not change input on default.
15	Image	Image Freeze	0 to 85 = Unfreeze image 172 to 255 = Freeze image 0 = Default	
16	Lamps/ Power	Power	0 to 85 = Power off (Switch lamps off, cool lamps down and go to Standby mode) 172 to 255 = Power on (Switch lamps on, warm up mode) 128 = Default	A five second timer is used before executing a power state change. If the slider moves out of the on/off range within the five seconds, the timer is cancelled. Does not change power state on default.
17	Reserved		Reserved for future expansion	No Reset
18	Reserved		Reserved for future expansion	No Reset

Mirage M Series Nitro VIP projector yoke personality

Channel	Group	Name	Description	Notes
1	Video	Fade to/from Black	0 to 85 = Black screen (Picture mute on) 172 to 255 = Live video (Picture mute off) 0 = Shutter closed 1 to 255 = Shutter open 255 = Default	If a value of 0 is set, the shutter is closed. Non-zero values open the shutter. To manually control the fade to black time, use the brightness channel to achieve the same effect.
2	Lens	Shutter	0 to 85 = Shutter closed (Black screen) 172 to 255 = Shutter open (Live video) 255 = Default	
3	Lens	Lens shift enable	0 to 85 = Lens shift disable 172 to 255 = Lens shift enable 255 = Default	Locks all lens motors
4	Lens	Zoom (coarse)	0 to 255 = Scaled as percentage of total control range, which is 0 to 2100 128 = Default (coarse) 0 = Default (fine)	Locked by channel Lens shift enable
5	Lens	Zoom (fine)		
6	Lens	Focus (coarse)	0 to 255 = Scaled as percentage of total control range, which is 0 to 2100 128 = Default (coarse) 0 = Default (fine)	Locked by channel Lens shift enable
7	Lens	Focus (fine)		
8	Lens	Lens Horizontal position (coarse)	0 to 255 = Scaled as percentage of total control range, which is 0 to 2100 128 = Default (coarse) 0 = Default (fine)	Locked by channel Lens shift enable
9	Lens	Lens Horizontal position (fine)		
10	Lens	Lens Vertical position (coarse)	0 to 255 = Scaled as percentage of total control range, which is 0 to 2100 128 = Default (coarse) 0 = Default (fine)	Locked by channel Lens shift enable
11	Lens	Lens Vertical position (fine)		

Channel	Group	Name	Description	Notes
12	Input	Input	Projector channel selection 1 to 20 = Projector channel 1 to 20 — 86 = LOAD — Input selection 111 to 116 = Slot 1, input 1 to 6 121 to 126 = Slot 2, input 1 to 6 131 to 136 = Slot 3, input 1 to 6 141 to 146 = Slot 4, input 1 to 6 — 171 = Execute 255 = Default	
13	Image	Size	0 to 255 = Scaled as percentage of total control range, which is 200 to 4000 67 = Default	
14	Image	Vertical Stretch	0 to 255 = Scaled as percentage of total control range, which is 200 to 3000 91 = Default	

Channel	Group	Name	Description	Notes
15	Macro	Function	Projector orientation 0 to 9 = Front projection 10 to 19 = Rear projection 20 to 29 = Front projection inverted 30 to 39 = Rear projection inverted — On-screen display 40 to 59 = On-screen display on 50 to 59 = On-screen display off 60 to 69 = Lens calibrate — 86 Load — Test Pattern 100 to 104 = Off 105 to 109 = Grid 110 to 114 = Grey Scale 16 115 to 119 = White 120 to 124 = Flat Grey 125 to 129 = Black 130 to 134 = Checker 135 to 139 = 13 Point 140 to 144 = Color Bars 145 to 149 = Aspect Ratio 150 to 154 = Edge Blend 155 to 159 = Boresight — 171 Execute — Image freeze 200 to 209 = Freeze image 210 to 219 = Unfreeze image 255 = Default	Lens Calibrate is locked by channel. Lens shift enable

Channel	Group	Name	Description	Notes
16	Lamp/ Power	Lamp/Power functions	<p>Lamp power</p> <p>Scaled as percentage of total control range.</p> <p>Examples are given for 350 W:</p> <p>00 = 0% 300 W</p> <p>—</p> <p>10 = 310 W</p> <p>—</p> <p>20 = 320 W</p> <p>—</p> <p>30 = 330 W</p> <p>—</p> <p>40 = 340 W</p> <p>—</p> <p>50 = 350 W</p> <p>—</p> <p>60 = 360 W</p> <p>—</p> <p>70 100% 370 W</p> <p>86 Load</p> <p>171 Execute</p> <p>Lamp mode</p> <p>90 = Auto select single lamp</p> <p>95 = Dual lamp mode</p> <p>Power mode</p> <p>100 = Power off (Switch lamps off, cool lamps down and go to Standby mode)</p> <p>105 = Power on (Switch lamps on, warm up mode)</p> <p>255 = Default</p>	
17	Colormetry	Brightness	<p>0 to 255 = Scaled as percentage of total range, which is 0 to 100</p> <p>128 = Default</p>	
18	Colormetry	Contrast	<p>0 to 255 = Scaled as percentage of total range, which is 0 to 100</p> <p>128 = Default</p>	
19	Colormetry	Gamma	<p>0 to 255 = Scaled as percentage of total range, which is -100 to 100</p> <p>128 = Default</p>	

Channel	Group	Name	Description	Notes
20	Colormetry	Video Signal/ Color space, Output Color, and CPF	<p>Color Space</p> <p>0 to 9 = RGB</p> <p>10 to 19 = YCbCr SDTV (ITU-R BT.601)</p> <p>20 to = 29 YCbCr HDTV (ITU-R BT.709)</p> <p>86 = Load</p> <p>Output color</p> <p>90 to 99 = Max drives</p> <p>100 to 109 = Color temperature (enables 21)</p> <p>110 to 119 = SD Video</p> <p>120 to 129 = HD Video</p> <p>130 to 139 = User setting 1</p> <p>140-149 = User setting 2</p> <p>150-159 = User setting 3</p> <p>160-169 = User setting 4</p> <p>171 = Execute</p> <p>Yellow Notch Filter</p> <p>180 to 189 = CPF Off</p> <p>190 to 199 = CPF On</p> <p>This is the global CPF control, not the channel control.</p> <p>255 = Default</p>	
21	Colormetry	Interpolated Color (Temperature)	<p>0 to 255 = Scaled as percentage of total control range, which is 3200 to 9300</p> <p>128 = Default</p>	Output Color control must be set to Color Temperature in DMX channel 20.

Channel	Group	Name	Description	Notes
22	Advanced Image	Blend and Warp/keystone enable	Blend 0 to 4 = Blend disable 5 to 9 = Standard blend enable 10 to 14 = User Blend 1 enable 15 to 19 = User Blend 2 enable — 60 to 64 = User Blend 11 enable 86 = Load 171 = Execute Output color 180 to 184 = Warp/keystone disable 185 to 189 = 2D Keystone enable 190 to 194 = Warp 1 enable — 240 to 244 = Warp 11 enable 255 = Default	The list of warp and blends available depends on the warps and blends saved on the projector by the user.
23	Real Time Events	RTE	0 to 9 = Cancel current running RTE 10 to 19 = Triggers RTE 1 20 to 29 = Triggers RTE 2 30 to 39 = Triggers RTE 3 40 to 49 = Triggers RTE 4 50 to 59 = Triggers RTE 5 60 to 69 = Triggers RTE 6 70 to 79 = Triggers RTE 7 86 = Load 171 = Execute 255 = Default	
24	Reserved		Reserved for future expansion	

Corporate offices

Christie Digital Systems USA, Inc.
Cypress
ph: 714 236 8610

Christie Digital Systems Canada Inc.
Kitchener
ph: 519 744 8005

Worldwide offices

Australia
ph: +61 (0) 7 3624 4888

Brazil
ph: +55 (11) 2548 4753

China (Beijing)
ph: +86 10 6561 0240

China (Shanghai)
ph: +86 21 6278 7708

France
ph: +33 (0) 1 41 21 44 04

Germany
ph: +49 2161 664540

India
ph: +91 (080) 6708 9999

Japan (Tokyo)
ph: 81 3 3599 7481

Korea (Seoul)
ph: +82 2 702 1601

Mexico
ph: +52 55 4744 1790

Republic of South Africa
ph: +27 (0)11 510 0094

Russian Federation
and Eastern Europe
ph: +36 (0) 1 47 48 100

Singapore
ph: +65 6877 8737

Spain
ph: +34 91 633 9990

United Arab Emirates
ph: +971 4 3206688

United Kingdom
ph: +44 (0) 118 977 8000

United States (Arizona)
ph: 602 943 5700

United States (New York)
ph: 646 779 2014

Independant sales consultant offices

Italy
ph: +39 (0) 2 9902 1161



For the most current technical documentation, visit www.christiedigital.com.

